

I-53

**ILLUMINATION
CATALOGUE**

Commercial

Northern Electric

COMPANY LIMITED

Digitized by:



ASSOCIATION FOR
PRESERVATION TECHNOLOGY,
INTERNATIONAL

BUILDING
TECHNOLOGY
HERITAGE
LIBRARY

www.apti.org

From the collection of:

CCA

CANADIAN CENTRE FOR
ARCHITECTURE /
CENTRE CANADIEN D'ARCHITECTURE

www.cca.qc.ca

ILLUMINATION

CATALOGUE

I-53

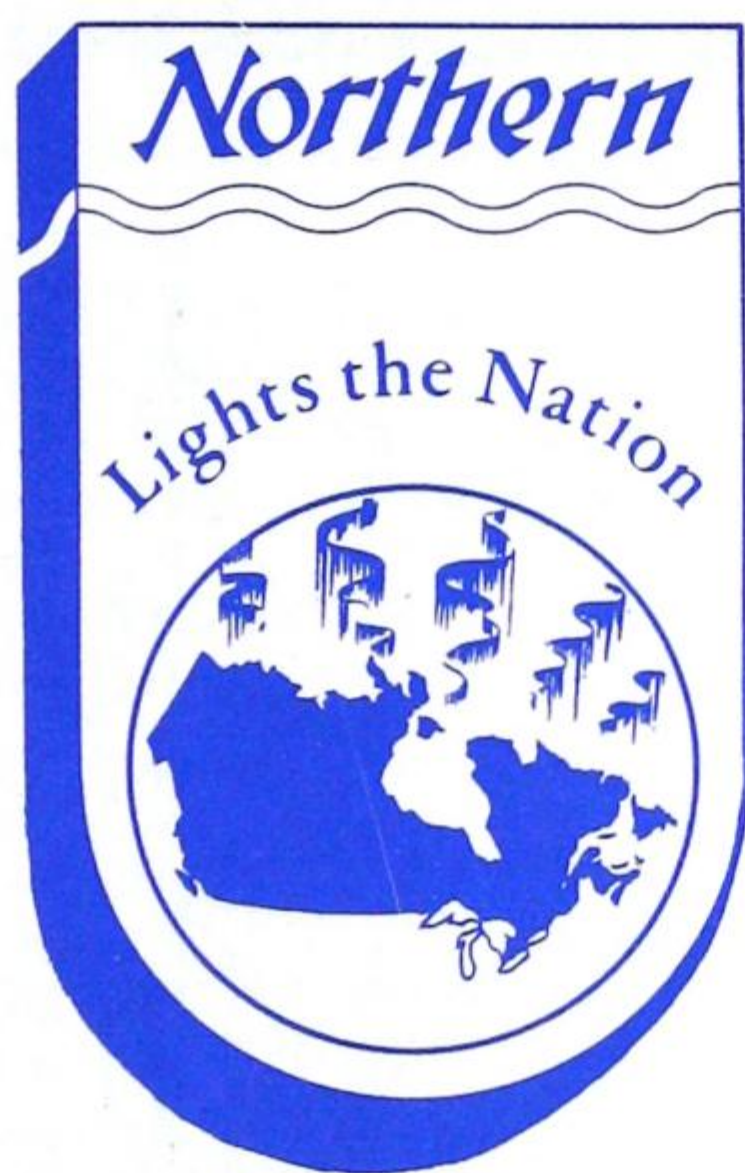

Commercial

Northern Electric

COMPANY LIMITED

1600 NOTRE DAME STREET WEST, MONTREAL, CANADA



Distributing Houses and Sales Offices

*ST. JOHN'S, NFLD.	157 Elizabeth Avenue		Telephone 7180
HALIFAX, N.S.	86 Hollis Street	P.O. Box 940	Telephone 3-9131
MONCTON, N.B.	599 Main Street	P.O. Box 279	Telephone 9176
*SAINT JOHN, N.B.	4 Hazen Avenue	P.O. Box 879	Telephone 2-1437
*SYDNEY, N.S.	361 George Street	—	Telephone 8398
MONTREAL, QUE.	1600 Notre Dame St. West,	P.O. Box 6125	Telephone WE. 7511
CHICOUTIMI, QUE.	259 Racine Street	P.O. Box 188	Telephone 4-4418
QUEBEC, QUE.	1299 Boulevard Charest	P.O. Box 1573	Telephone 7-3423
SHERBROOKE, QUE.	C.P.R. Terrace	P.O. Box 419	Telephone 2-3821
TROIS RIVIERES, QUE.	2620 Notre Dame Street	P.O. Box 457	Telephone 4333
VAL D'OR, QUE.	1068-7th Street	P.O. Box 280	Telephone 888-889
L'ABORD-A-PLOUFFE, QUE.	53 Blvd. Levesque	P.O. Box 15, Stat. O, Montreal	Telephone MURray 1-1668
OTTAWA, ONT.	141 Catherine Street East,	P.O. Box 237	Telephone 2-9693
TORONTO, ONT.	143 Fleet Street East,	P.O. Box 130, Terminal A	Telephone EMpire 3-8651
HAMILTON, ONT.	157 Main Street East	P.O. Box 12	Telephone 7-2944
KINGSTON, ONT.	857 Princess Street	P.O. Box 350	Telephone 3358
KIRKLAND LAKE, ONT.	8 Hudson Bay Avenue	P.O. Box 1058	Telephone 1444
LONDON, ONT.	292 King Street	P.O. Box 278	Telephone 2-7173
SUDBURY, ONT.	341 Douglas Street	P.O. Box 37	Telephone 6-6479
TIMMINS, ONT.	251 First Avenue	P.O. Box 628	Telephone 2334
WINDSOR, ONT.	1825 Walker Road	P.O. Box 293	Telephone 4-3261
SARNIA, ONT.	197 North Christina St.	P.O. Box 344	Telephone Digby 7721
WINNIPEG, MAN.	65 Rorie Street	P.O. Box 2969	Telephone 927-531
FORT WILLIAM, ONT.	125 S. Vickers Street	P.O. Box 250	Telephone 3-6419
*BRANDON, MAN.	321-10th Street	P.O. Box 232	Telephone 4465
REGINA, SASK.	2300 Dewdney Avenue	P.O. Box 70	Telephone 92-531
*SASKATOON, SASK.	211 Birks Bldg.	—	Telephone 29-131
EDMONTON, ALTA.	10305-106th Street	—	Telephone 24181 and 43141
CALGARY, ALTA.	1207-11th Ave. W.	—	Telephone 48911
LETHBRIDGE, ALTA.	1108-1st Ave. S.	P.O. Box 603	Telephone 2452 and 4953
*CRANBROOK, B.C.	321-14th Avenue	—	Telephone 886R
VANCOUVER, B.C.	150 Robson Street, Vancouver 3, B.C.	—	Telephone TAtlow 8111
VICTORIA, B.C.	1950 Blanshard Street	—	Telephone EMpire 1116
VERNON, B.C.	2901-31st Street	P.O. Box 278	Telephone 25 and 825
*NANAIMO, B.C.	75 Bastion Street	P.O. Box 96	Telephone 395
*TRAIL, B.C.	1234 Bay Avenue	—	Telephone 1639
*NEW WESTMINSTER, B.C.	Room No. 2, B.C. Electric Depot	—	Telephone N.W. 3530
*PENTICTON, B.C.	416 Tennis Street	—	Telephone 60Y
*PRINCE GEORGE, B.C.	1173-4th Avenue	P.O. Box 1310	Telephone 268R2

*Sales Offices

INFORMATION

ORDERS

When specifying material please quote the catalogue number where possible and give a description of the article required.

TERMS

Our general terms are 30 days net from date of invoice. Cash discount for payment within ten days from date of invoice may be deducted as authorized in the terms shown on our invoices, except where special quotations apply.

Payments may be made by cheque, bank draft, postal or express money order, drawn to the order of the Northern Electric Company Limited.

Payment in currency through the mails is not recommended. Registered mail may be sent at the sender's risk. We are not responsible for loss or miscarriage of the mails.

Receipts are not issued for remittances unless requested. Our endorsement on remittance is acknowledgment of the receipt of the funds.

We solicit new accounts on a credit basis, and in order to give prompt service, request those purchasers who are not rated by the Commercial Agencies to send references or other information of a credit character with the order. These will be immediately acted upon, and the result held in strict confidence for our sole use, and, when reasonably satisfactory, shipment will follow with all possible despatch.

To avoid the delay incidental to communicating with the references, etc., it would be acceptable, when immediate shipment is desired, to instruct us to ship C.O.D., by express, parcel post, or freight.

We shall advise new customers of the terms on future orders promptly after communications from references are received.

RETURNED GOODS

No credit will be allowed for goods returned without our written permission. Should material be supplied that is not in accordance with specifications, or prove to have any manufacturing defects, we are prepared to replace it, provided that we are notified in writing within thirty days after shipment, but no claim will be allowed for expense incurred in installing or using same, or for any other damage.

SHIPMENTS

Customers are requested to specify the method of shipment (whether air, rail, steamer, express or parcel post) and specify routing they prefer. In the absence of specific instructions we will use our best judgment in selecting the manner of shipment and the route, but we cannot accept responsibility for extra delivery charges at destination.

We employ only experienced packers who use reasonable care in packing; consequently we cannot be held responsible for breakage in packages which are delivered in "good order" to the carrier.

The transportation companies handle glassware and some other articles at "owner's risk". We are not responsible for damage to such shipments. All goods ordered to be shipped by parcel post are also at purchaser's risk, although we will arrange insurance on such shipments if requested to do so.

Copyright 1953
NORTHERN ELECTRIC COMPANY LIMITED

CONTENTS

PAGE

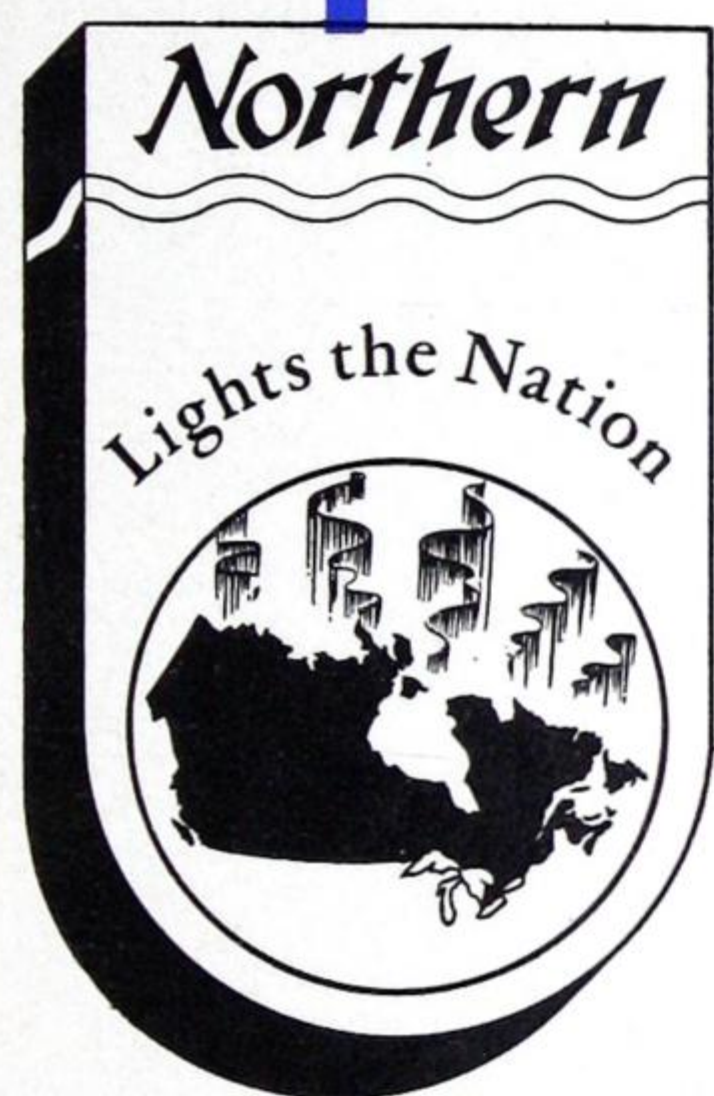

BASIC DESIGN DATA

11

LAMPS

25

COMMERCIAL LIGHTING
INCANDESCENT

35

COMMERCIAL LIGHTING
FLUORESCENT

107

FLUORESCENT ACCESSORIES

177

STAGE LIGHTING

185

PORTABLE & EMERGENCY LIGHTS

203

ALPHABETICAL INDEX

209

NUMERICAL INDEX

211

*For INDUSTRIAL LIGHTING EQUIPMENT — Refer
to Illumination Catalogue I-53 Industrial Lighting*

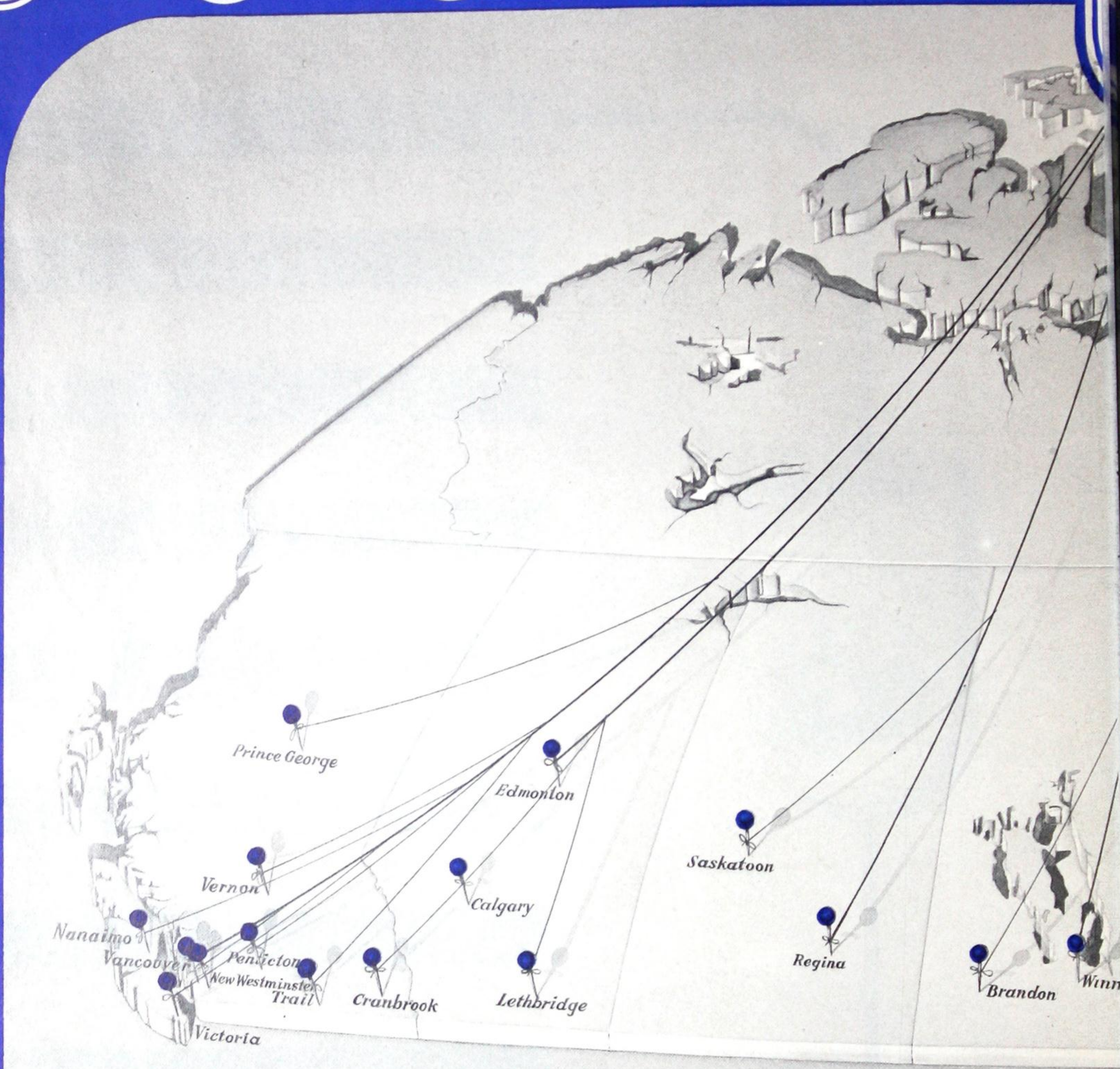

Use the

Northern Electric

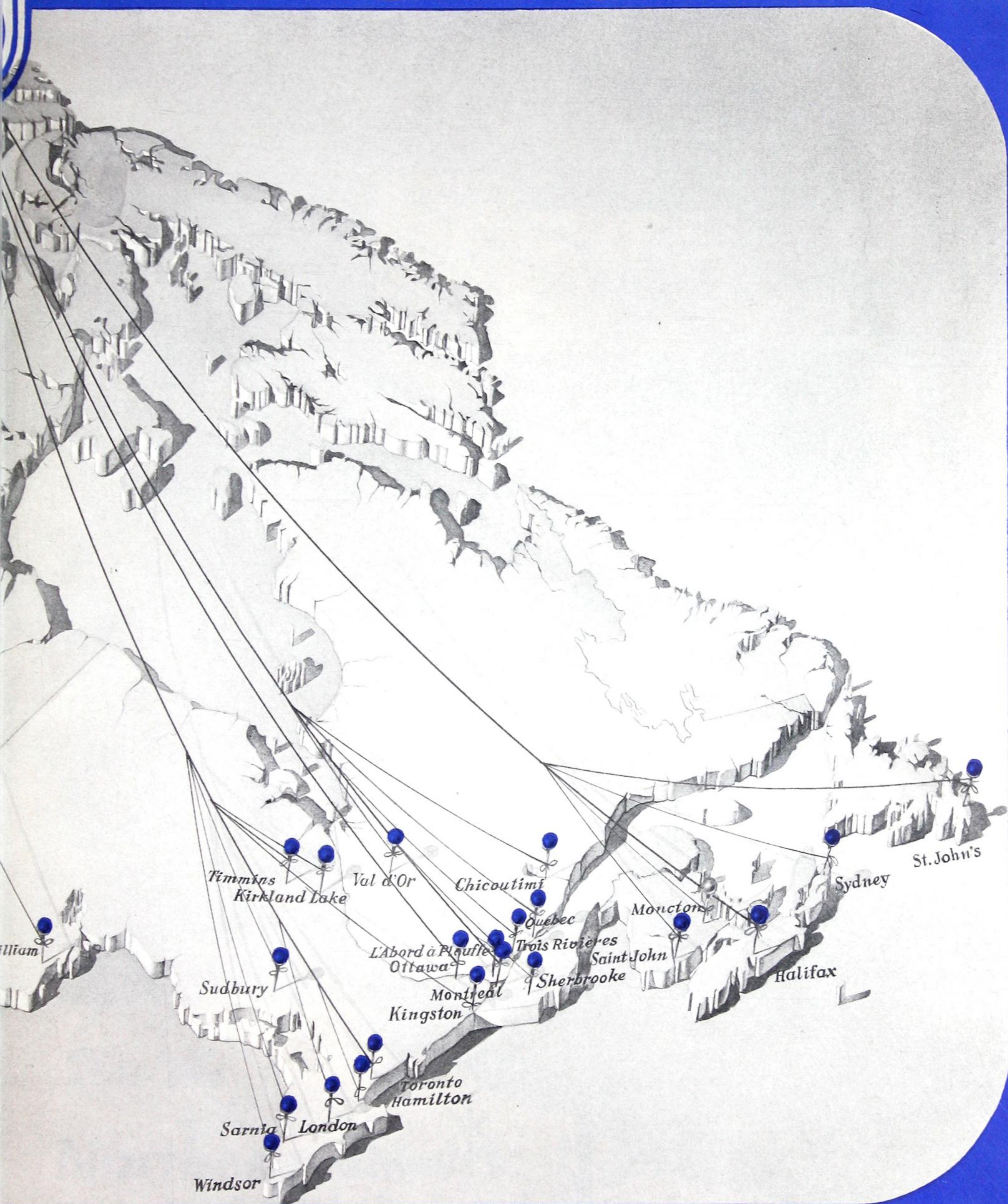

William
Timmins
Kirkland Lake
Sudbury
Windsor
London
Sarnia
Kingston
Toronto
Hamilton
Val d'Or
L'Abord à Plouffe
Ottawa
Montreal
Chicoutimi
Quebec
Trois Rivières
Sherbrooke
Moncton
Saint John
Halifax
Sydney
St. John's

Lighting Service

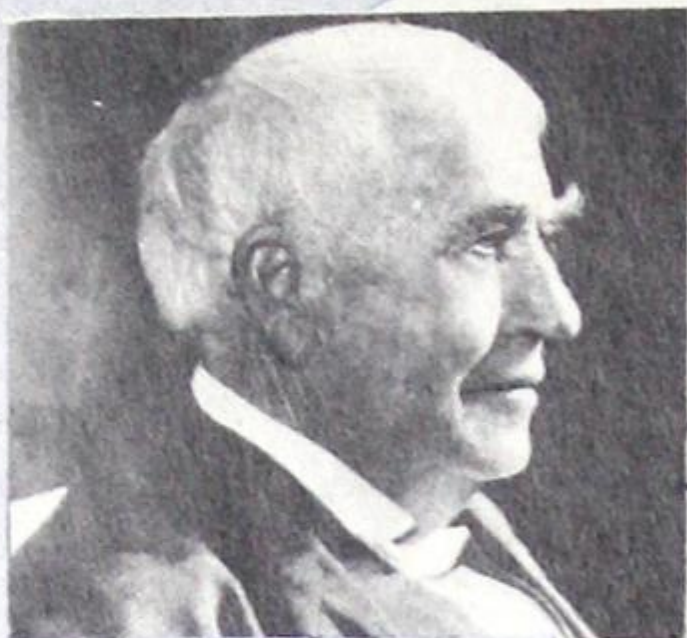

Thomas Alva Edison Foundation Inc.

W. W. W.
H. F. when 65/100
all the lamps die - the
total hours run to
reach this point will be the
average life of lamps when
the 135th lamp goes that will
be the life ^{of yours} - I should say
200 hours will be reached
will reach

Lamps
through the
ages

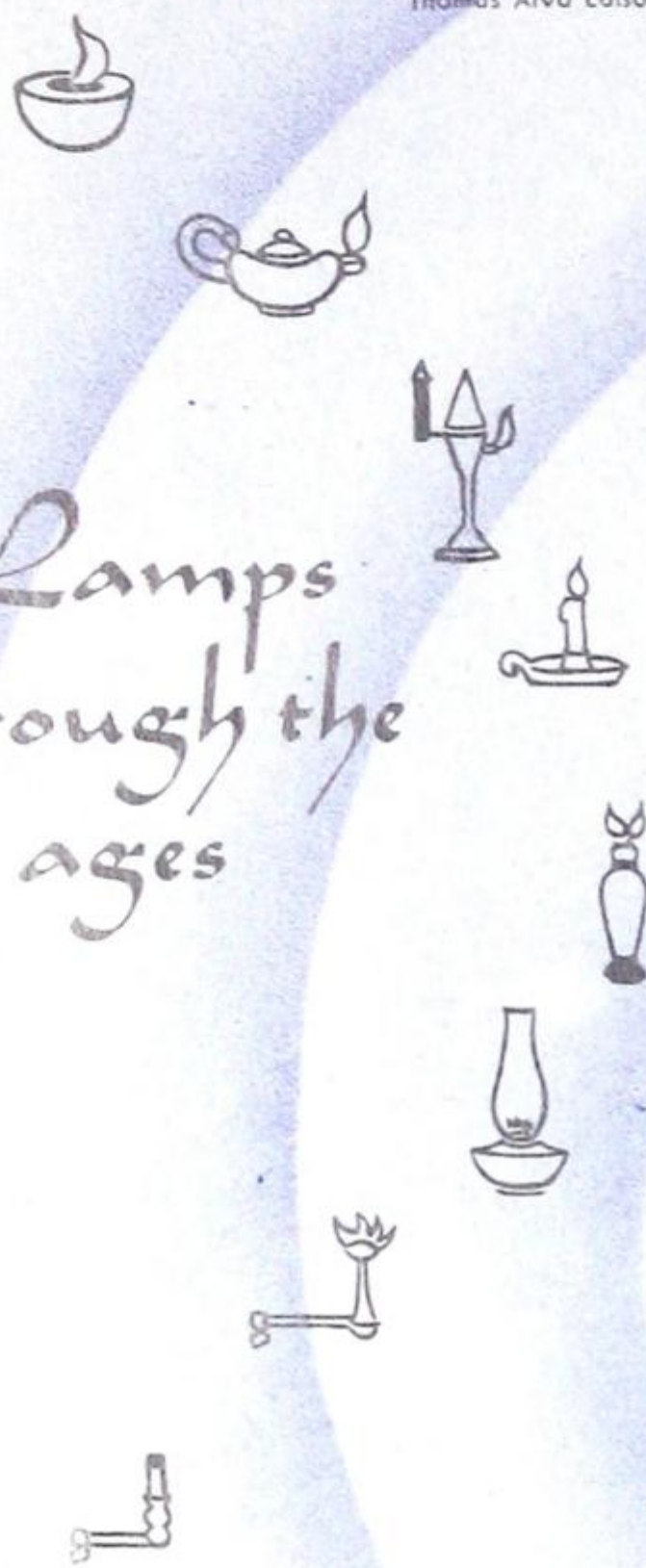

Every
lighting problem
can be
solved *

Thos Edison,

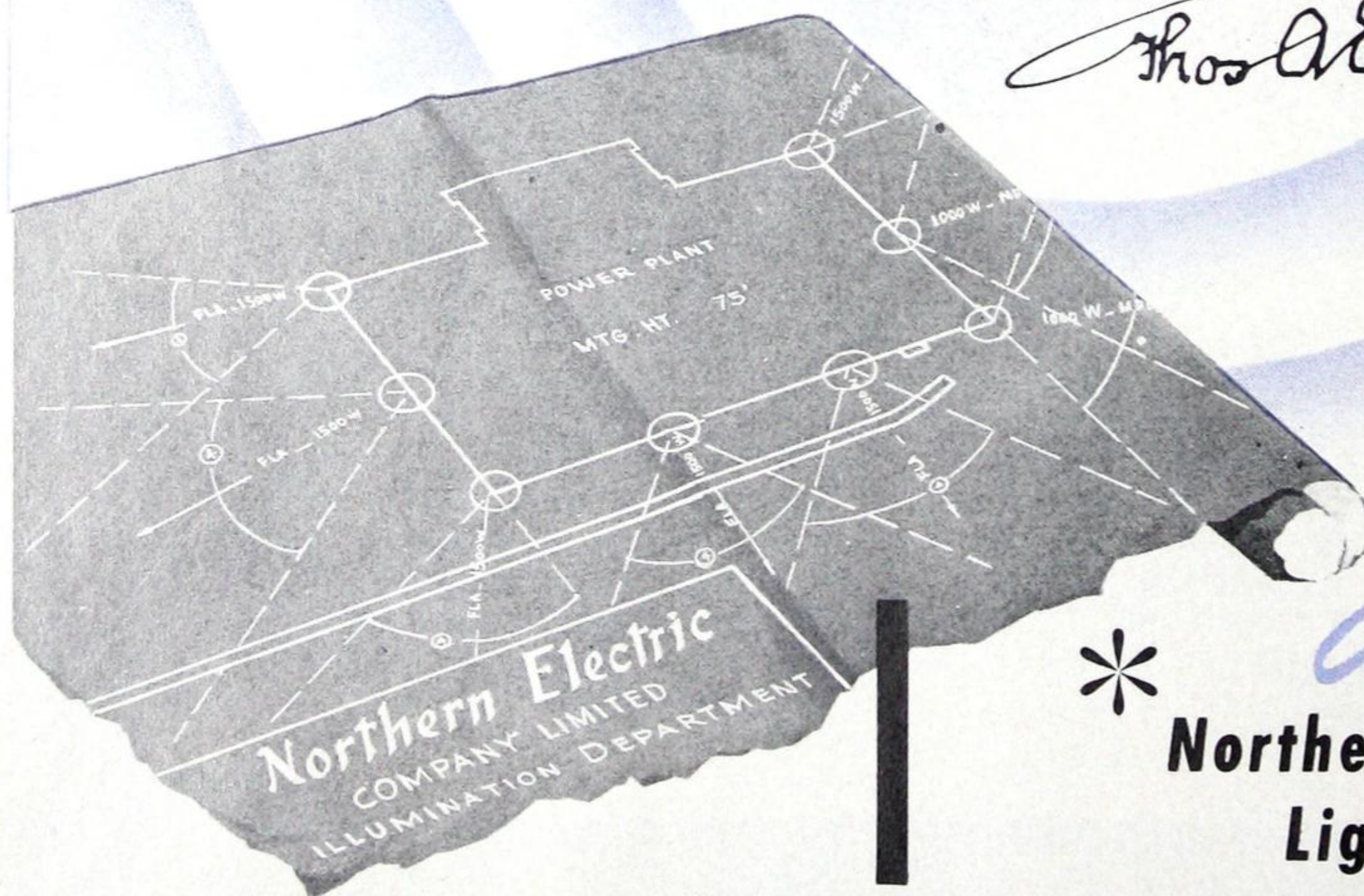

Use the
**Northern Electric
Lighting Service**

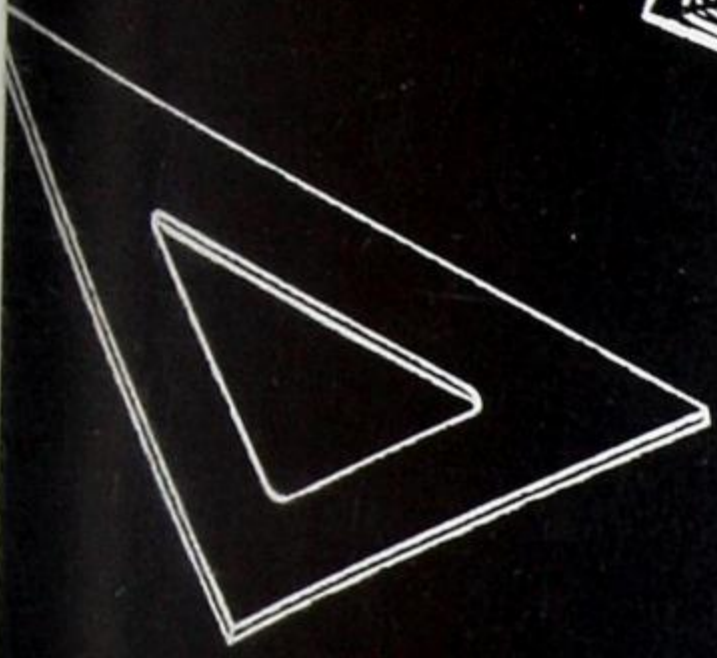
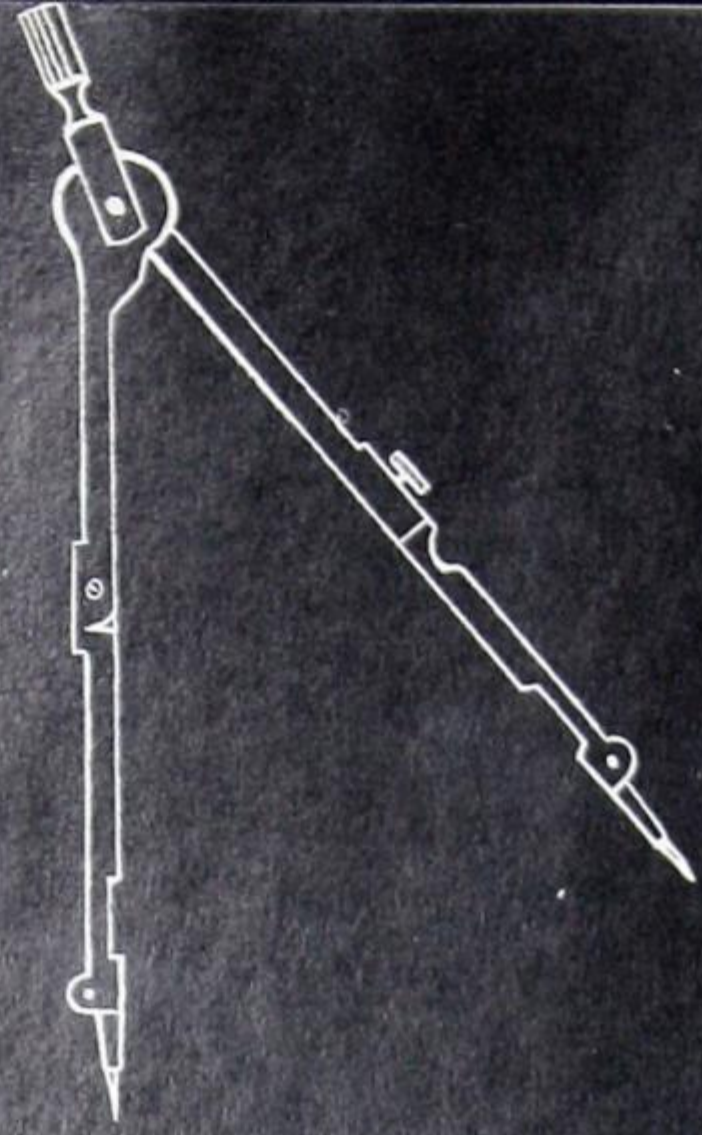
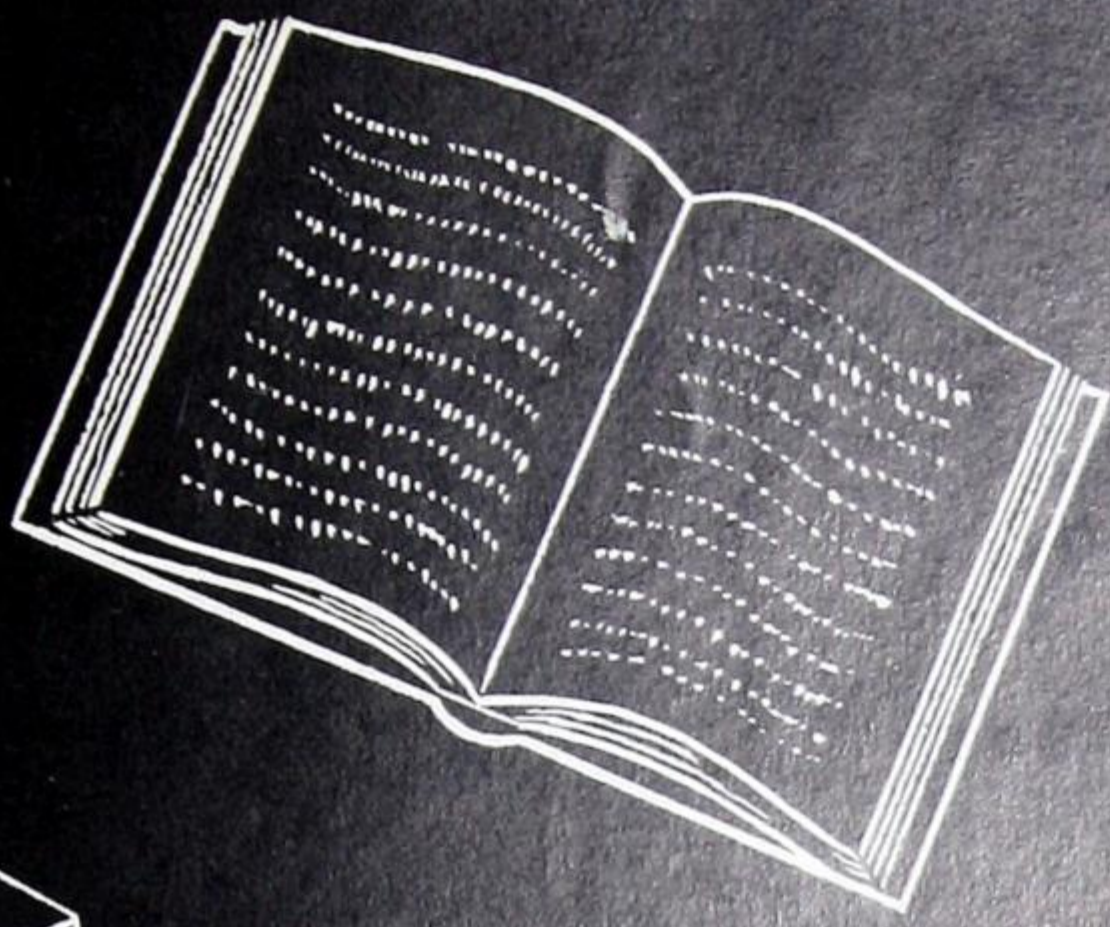

BASIC DESIGN DATA

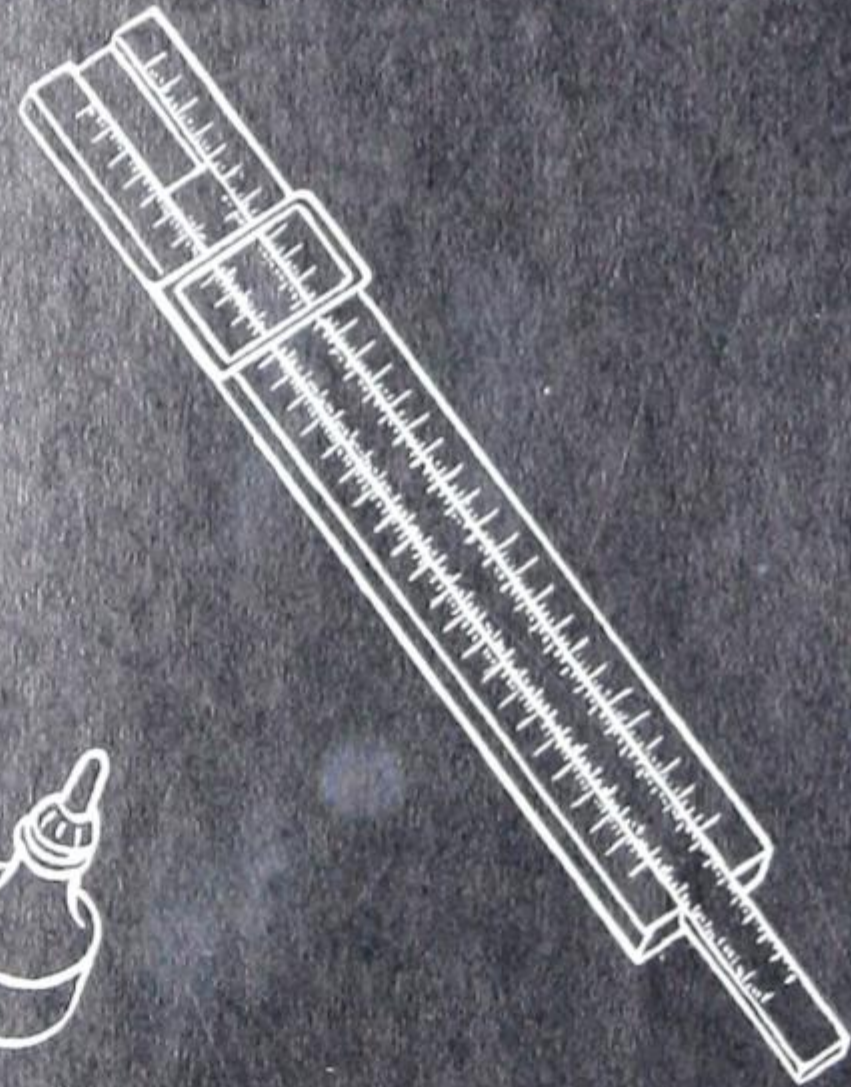
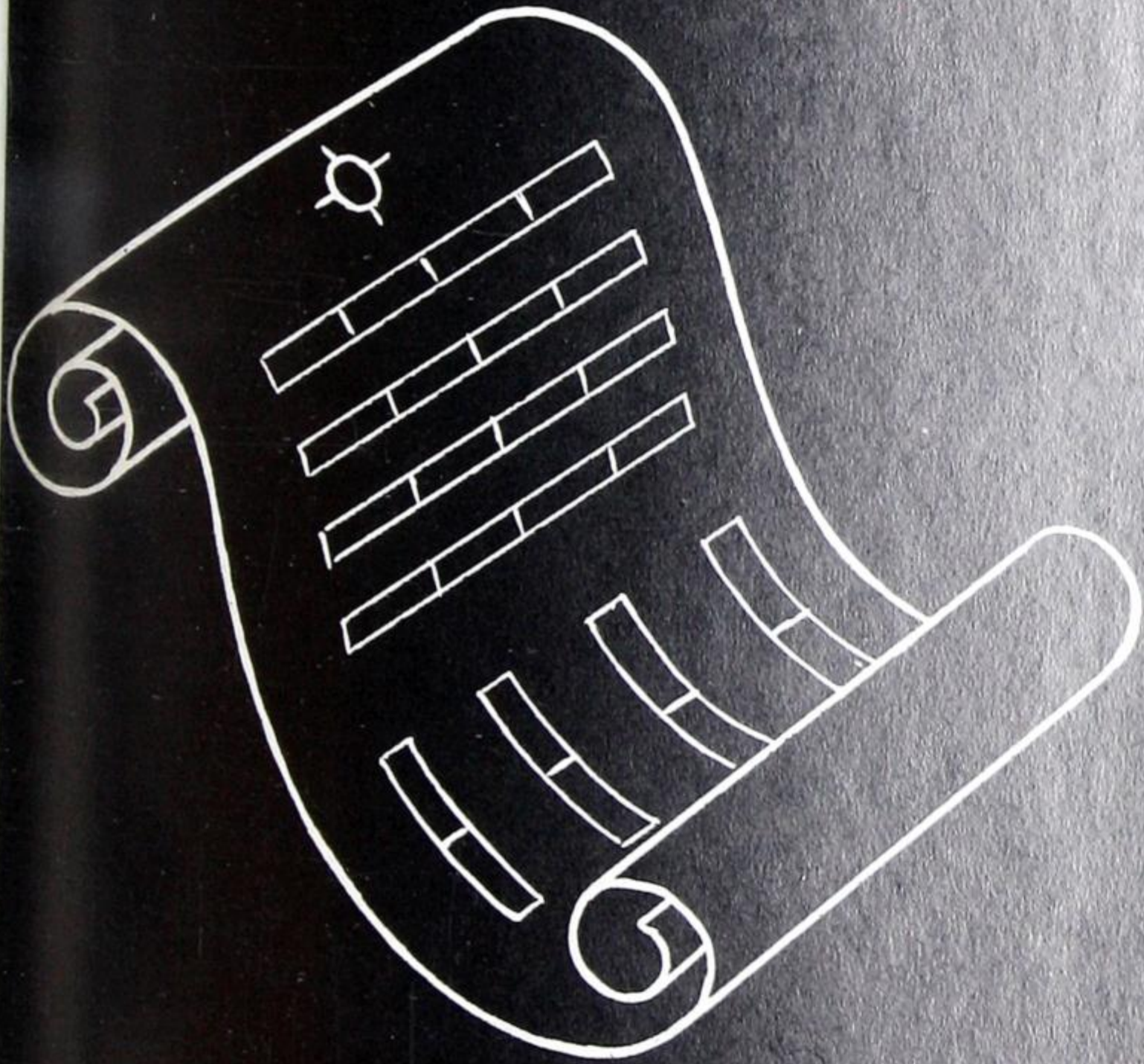
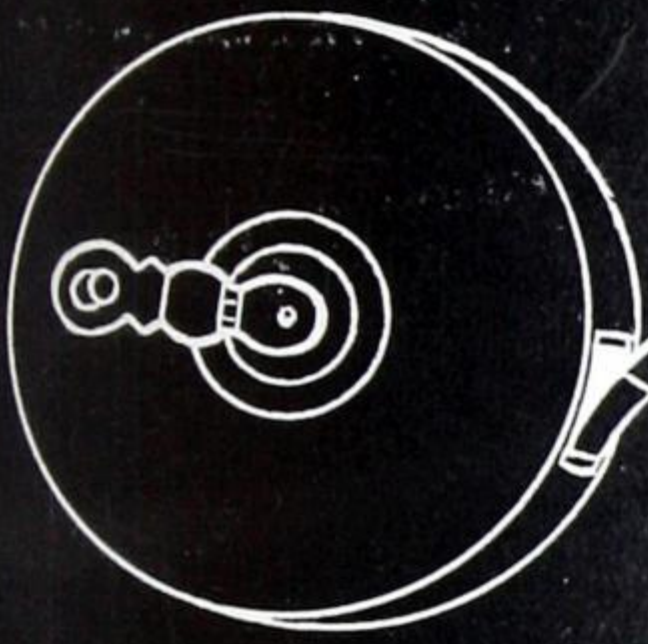

Use the

Northern Electric Lighting Service



BASIC ILLUMINATION DESIGN DATA

Factors Affecting Design Problems

GENERAL CONSIDERATIONS

- 1. Room Function
 - 2. Structural Features
 - 3. Colour Harmony
 - 4. Personnel
 - 5. Housekeeping
- 1

FACTORS AFFECTING METHOD OF LIGHTING

- 1. Texture
 - 2. Colour
 - 3. Elevation
 - 4. Operative Process
 - 5. Colour Contrast
 - 6. Shadows
 - 7. Highlights
 - 8. Silhouette
- 2

FACTORS AFFECTING AMOUNT OF LIGHT

- 1. Size
 - 2. Contrast
 - 3. Reflection Factors
 - 4. Movement
 - 5. Time
- 3

RECOMMENDED VALUE OF LIGHT

Determination of the required quantity of illumination for the specific visual task or tasks.

4

METHOD OF LIGHTING

- 1. General
 - 2. Local
 - 3. Localized
 - 4. Special
- 5

FACTORS AFFECTING CHOICE OF FIXTURES AND LIGHT SOURCE

- 1. Distribution
 - 2. Brightness
 - 3. Mechanical Features
 - 4. Efficiency
 - 5. Spectral Characteristics
- 6

ROOM INDEX

- 1. Room Proportions
 - 2. Floor Area
 - 3. Mounting Height
 - 4. Light Distribution
- 7

COEFFICIENT OF UTILISATION (C.U.)

- 1. Reflection Factors (Walls, Ceiling)
 - 2. Room Index
 - 3. Type of fixture
- 8

DESIGN FORMULAE

$$\text{Total Lumens} = \frac{\text{Footcandles} \times \text{Area}}{\text{Coefficient of Utilisation} \times \text{Maintenance Factor}}$$

$$\text{Number of Lamps} = \frac{\text{Footcandles} \times \text{Area}}{\text{Lumens per Lamp} \times \text{Coefficient of Utilisation} \times \text{Maintenance Factor}}$$

$$\text{Luminaires} = \frac{\text{Footcandles} \times \text{Area}}{\text{Lamps per Luminaire} \times \text{Lumens per Lamp} \times \text{Coefficient of Utilisation} \times \text{Maintenance Factor}}$$

$$\text{Footcandles} = \frac{\text{Lamp Lumens} \times \text{Coefficient of Utilisation} \times \text{Maintenance Factor}}{\text{Area}}$$

$$\text{Area per Luminaire} = \frac{\text{Lamps per Luminaire} \times \text{Lumens per Lamp} \times \text{Coefficient of Utilisation} \times \text{Maintenance Factor}}{\text{Footcandles}}$$

9



BASIC ILLUMINATION DESIGN DATA

This section of the catalogue reviews the basic factors in illumination design data. It will summarize the fundamental relationship between light and sight the importance of colour harmony and the basic terms and formulae used in lighting design. It will discuss some of the factors mentioned in the above table, other factors will be elaborated upon in the design data sections of the commercial and industrial portions of the catalogue.

The specific application of these basic factors, as applied to individual applications, industrial and commercial lighting, flood-lighting, and stage lighting will be found at the beginning of the sections of the catalogue devoted to these applications.

Light and Vision—Sight is the most important of man's senses. Without light, the eyes are useless; with poor lighting they cannot operate at maximum efficiency. For the design of any lighting installation, the prime objective is to provide an environment in which the eye may operate at its highest efficiency. Light must be provided to allow the performance of any visual task, with the maximum of speed, accuracy and comfort, and with the minimum of strain and fatigue.

EYE ACCOMMODATION—The mechanism of the eye readily adjusts itself to changing conditions for close or distant vision. This is part of the process known as *accommodation*.

EYE ADAPTATION—Similarly, the lens opening of the eye changes, depending upon the amount of illumination or the brightness of the object viewed. This process is known as *adaptation*.

EFFECT OF ENVIRONMENT UPON EYE ACCOMMODATION AND ADAPTATION—The general environment of any location will influence the amount of accommodation or adaptation demanded of the visual senses. If this demand is excessive, and causes constant changes, the effect upon the nervous system may be detrimental and conducive to nervous disorders, fatigue and impaired human efficiency.

Lighting is an important part of any environment and good lighting can do much to improve the seeing comfort of any specific location.

FOUR FACTORS IN SEEING—Seeing comfort depends upon four basic factors: the size of the object, its brightness, the contrast between the object and its background, and the time taken to observe the object.

Size—A large object is more easily seen than a small one; when a small object is brought closer to the eye to see it more clearly, it in effect becomes larger. Lighting does the same thing; as the amount of illumination upon a specific object increases, it is more easily seen. In effect, light acts as a "magnifier", making visible small details that would not be seen with poor lighting.

Brightness—The brightness of an object depends upon both the intensity of the light falling upon it, and the proportion of that light reflected in the direction of the eye. A light surface will reflect more light than a dark surface, therefore, a white object would have a much higher brightness than a black object receiving the same amount of illumination. The intensity of illumination would be the same, but the amount of that light reflected back to the eye would be greater from the white object. However, by adding enough light to a dark object, its brightness may be increased. The darker the object or visual task, the greater the illumination required for comfortable seeing and good visibility.

Contrast—Contrast or the difference in brightness levels or colour between the object of regard and its background is just as important as the brightness level of the object itself. High levels of illumination in some respect compensate for poor contrasts between the object and its background and are very important where poor contrast conditions cannot be improved by other means.

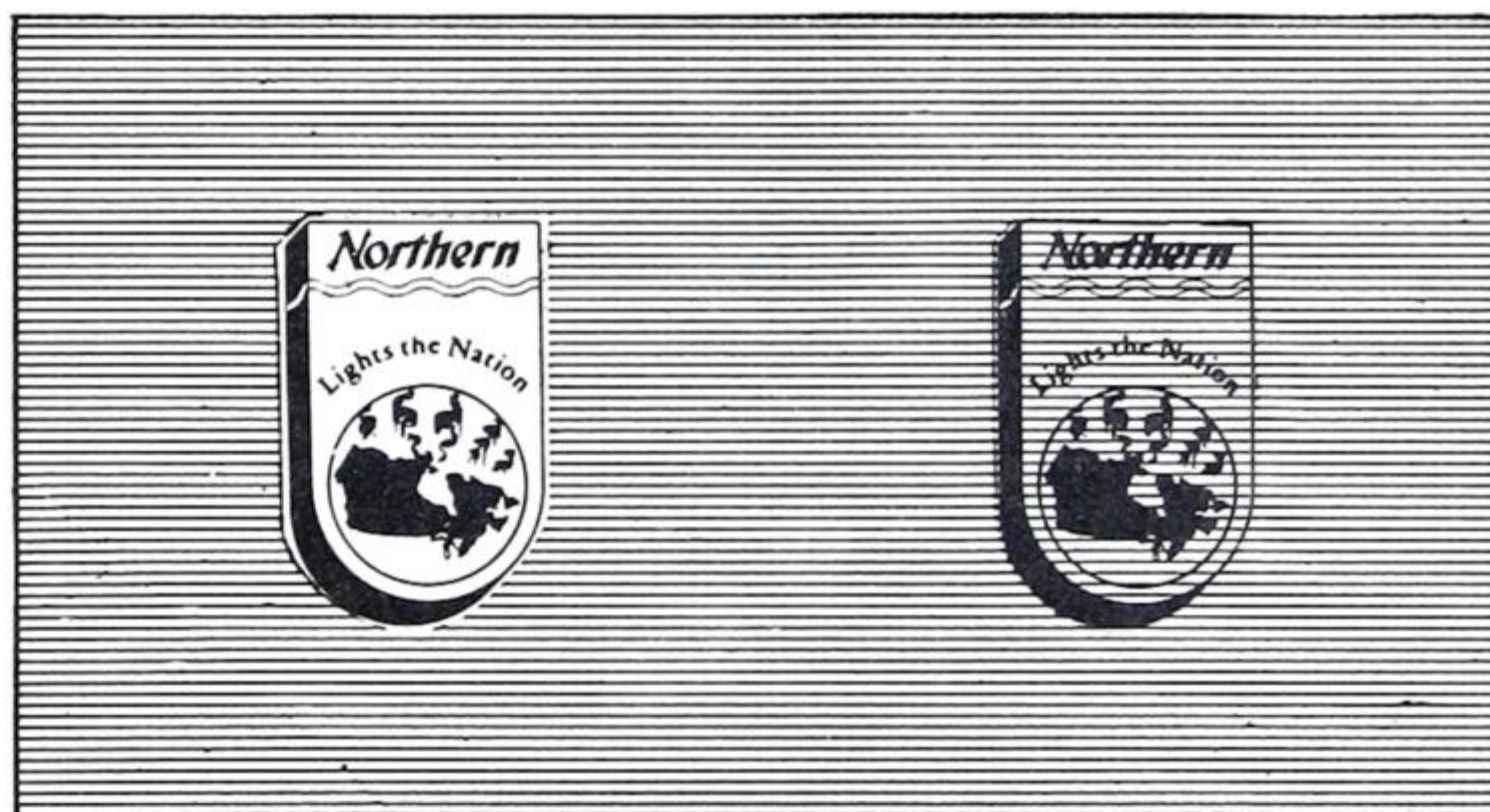
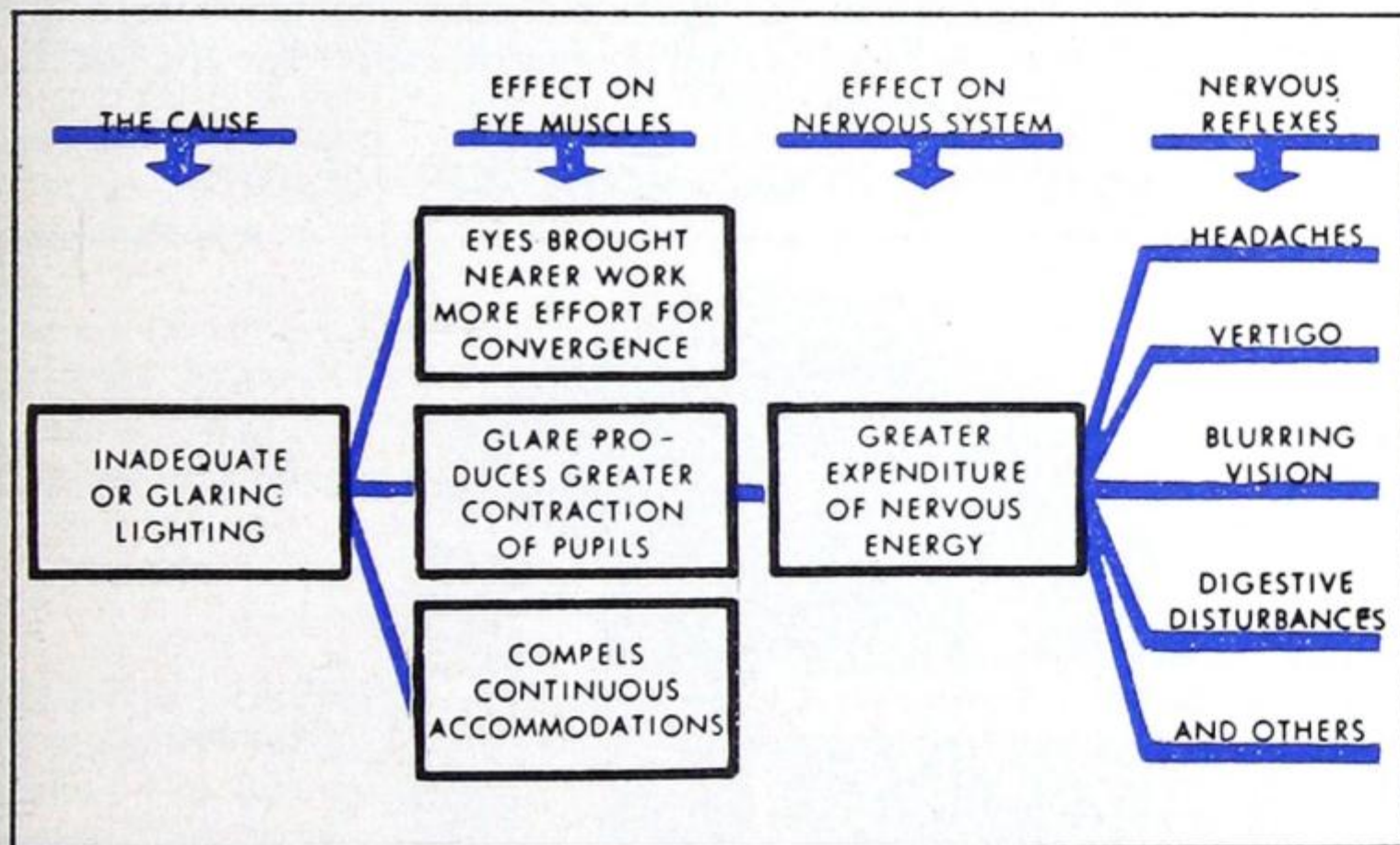

AN OBJECT WITH A HIGH REFLECTION FACTOR IS MORE EASILY SEEN

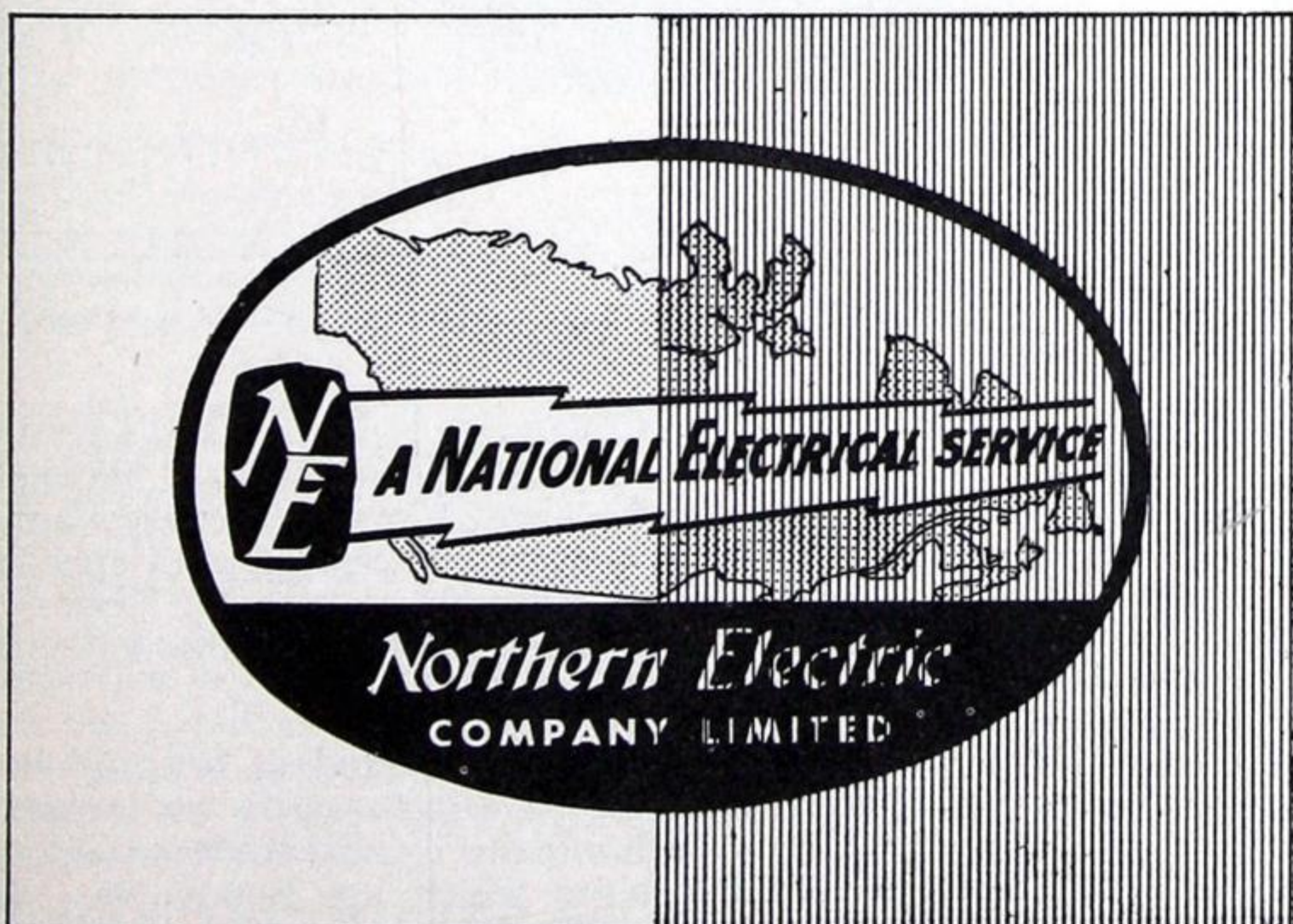

CORRECT CONTRAST IS ESSENTIAL TO COMFORTABLE SEEING.

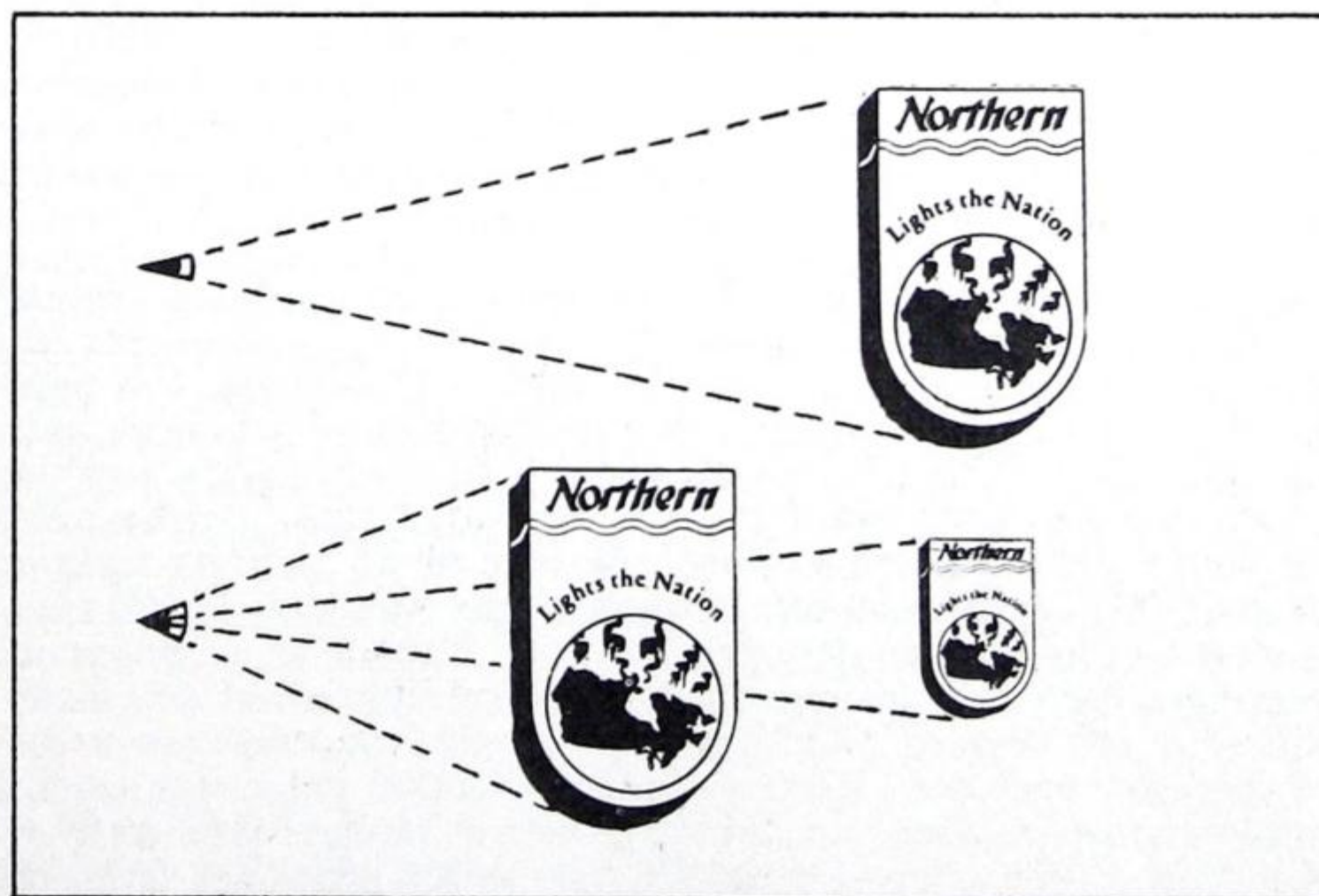

GREATER ILLUMINATION ON A SMALL OBJECT HAS THE EFFECT OF "MAGNIFYING" IT. MOVING A SMALL OBJECT CLOSER TO THE EYE MAKES IT APPEAR LARGER.

BASIC ILLUMINATION DESIGN DATA



Light, colour and environment in government offices - Illuminating Engineering

REPAINTING OF THE MACHINES AND USE OF LIGHT FLOOR COVERING AS SHOWN IN THE ABOVE PHOTOGRAPHS ELIMINATED HIGH BRIGHTNESS RATIOS BETWEEN THE WORK AND THE SURROUNDINGS PROVIDING FOR GREATER SEEING COMFORT, LESS FATIGUE AND IMPROVED APPEARANCE.

Time—The eye does not operate instantaneously; it requires time to accommodate or adapt itself to each visual task. With low levels of illumination more time is required to perceive a specific object than would be required to see the same object with a higher level of illumination; with more light the eye will also operate more efficiently and with less strain. The time factor is of particular importance where fast moving objects are concerned. In such cases, high values of illumination tend to act as a "brake" and make fast moving objects appear to move more slowly, and improve visibility.

coloured finishes impart an atmosphere of cheerfulness and efficiency, encourage greater production, better health and morale, stimulate good housekeeping and help reduce accident rates.

All light sources produce light of distinctive spectral characteristics, that is, of a specific colour make-up. This makes coloured surfaces look different under different light sources. It is important, therefore, to select a suitable light source for the specific application under consideration.

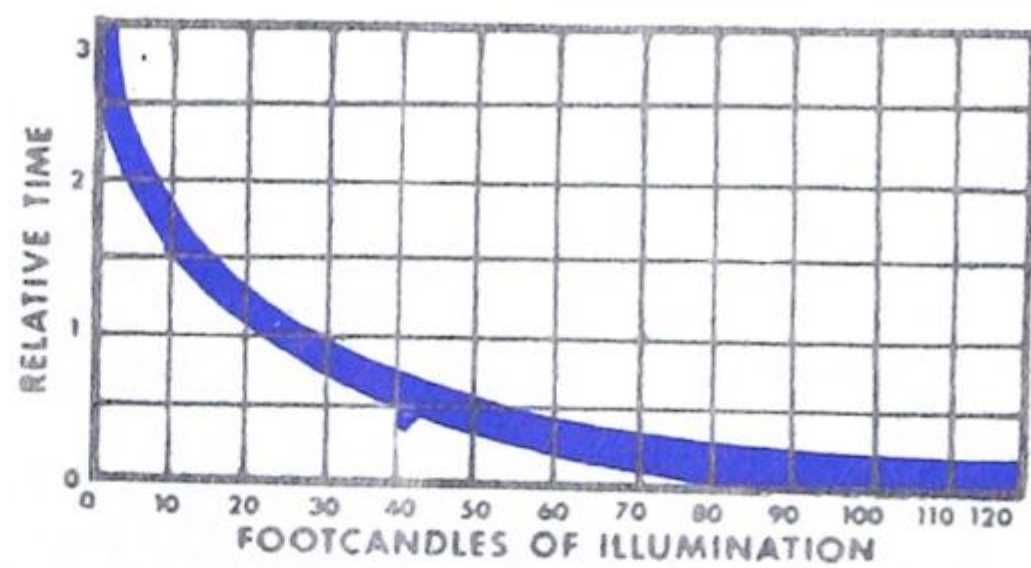

IT TAKES TIME TO SEE, THE MORE LIGHT, THE LESS TIME SPENT IN TRYING TO SEE... THE MORE TIME FOR PRODUCTIVE WORK.

Size, Brightness, Contrast and Time are interrelated; to some extent lighting correctly applied will compensate for a deficiency in one or more of these factors. Size of the object of regard is usually a fixed factor; time to view the object is fixed to a lesser extent, and brightness and contrast more readily subject to modification by illumination or other methods.

LIGHT AND COLOUR—The efficiency of any lighting systems depend to some extent upon the selection of colours for the painting of building interiors, the walls and ceilings, the finish of the floors and furniture and the shielding of windows after daylight fails. The amount of useful light reaching the working plane depends upon the reflection factors of these finishes; this is particularly important when considering an indirect lighting system, as in such cases all the useful light is reflected from these surfaces before it reaches the working plane. It is apparent, therefore, that the efficiency of the general lighting of any establishment will depend to a large degree upon the reflection values of the room surfaces. Recommended reflection values for specific applications are given in the appropriate design data sections. Apart from the value of obtaining the fullest efficiency from the lighting installation the selection of suitable finishes affects the general environment of the premises under consideration. Dark or dirty walls and ceilings are cheerless and depressing, light

LIGHTING TERMS AND DEFINITIONS

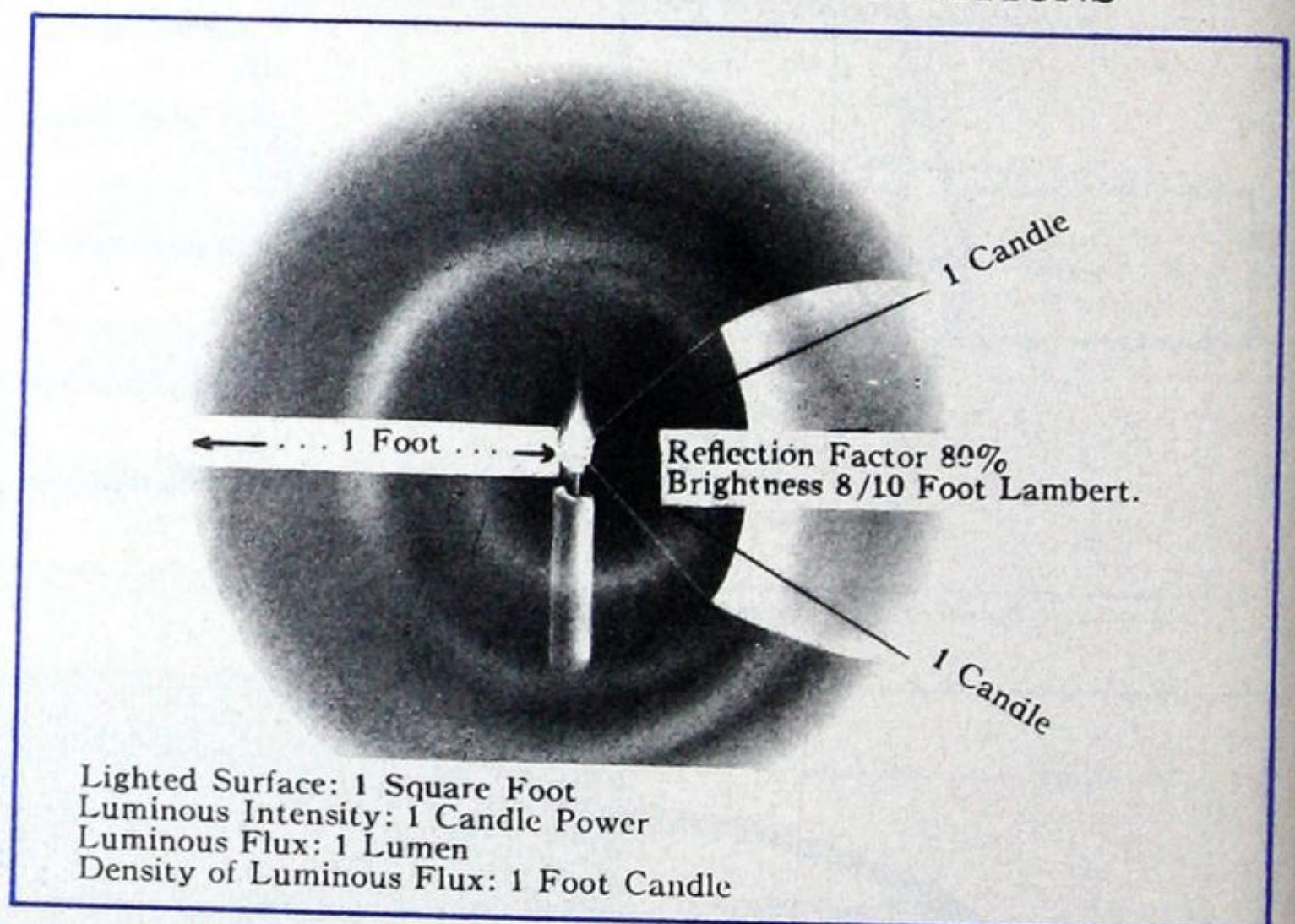

LIGHT—For the purposes of illuminating engineering is visually evaluated radiant energy.

LAMP OR LIGHT SOURCE—Filament or incandescent lamps —A light source consisting of a glass bulb containing a filament electrically maintained at incandescence. Electric discharge lamp —A lamp in which light is produced by the passage of electricity through a metallic vapour or a gas such as mercury, sodium, neon, argon, etc., enclosed in a tube or bulb; sometimes called a vapour lamp.

LUMINAIRE—A complete lighting unit including lamp, globe, reflector, refractor, housing and such support as is an integral part of the housing. The term luminaire is used to describe any completely equipped lighting units which are removable. It does not include complete luminous ceilings or other permanent structural elements.



BASIC ILLUMINATION DESIGN DATA

LUMINOUS FLUX—The time rate of flow of light. Light is actually a form of radiant energy in motion. In common practice, however, the time factor is neglected and luminous flux is considered as a definite quantity. The unit of luminous flux is the Lumen and the symbol "F".

LUMEN—The light flux falling on a surface one square foot in area, every part of which is one foot from a uniform point source of one candle—(A one foot square section of a sphere of one-foot radius with a source of one candlepower at its center.)

The lumen differs from candlepower in that it is a measure of light flux *irrespective of direction*.

Although accurate lumen measurements of light sources are a laboratory procedure requiring special equipment, an estimate of the number of lumens falling upon a surface may be obtained by multiplying the area of the surface in square feet by the average footcandle value of the surface.

Lumens striking a surface = Footcandles x Area in square feet.

Lumens emitted from a surface = Footlamberts x Area in square feet.

Lumens = Mean Spherical Candlepower (MSCP) x 12.57.

LUMINOUS INTENSITY—The solid angular luminous flux density in a specific direction.

The unit of luminous intensity is the Candle and the symbol "I". The luminous intensity of a source expressed in candles is its candlepower.

CANDLEPOWER—Indicates the luminous intensity of a light source or luminaire in a specific direction or plotted to indicate the light distribution at various angles in the form of a candlepower distribution curve. Such distribution curves are used in illumination calculations.

Candlepower measurements are primarily a laboratory procedure. For field work however rough estimates may be made for candlepower measurements of a light source or luminaire by holding a lightmeter at a distance of at least five times the greatest dimension of the source of light, aiming the cell of the meter directly at the light source, and multiplying the footcandle reading obtained by the square of the distance in feet. There should be no other light in the room and in confined areas it may be necessary to take into consideration reflected light from walls and ceilings.

Candlepower (CP) = Footcandles (ft-c) x Square of the distance in feet from illuminated surface (D²).

Mean Spherical Candlepower (MSCP) is the average candlepower of a source in all directions.

$$MSCP = \frac{\text{Lumens}}{12.57}$$

ILLUMINATION—The density of luminous flux incident upon a surface. It equals the quotient of flux by the area of the surface when the flux is uniform over the area. Luminous flux may be visualized as the cause and illumination the effect. The unit of illumination is the Footcandle (ft-c) and is represented by the symbol "E". It represents lumens per square foot. A footcandle is the illumination at a point on a surface which is one foot from and perpendicular to a uniform point source of one candle.

BRIGHTNESS—The luminous intensity of any surface in a given direction, per unit of projected area of the surface viewed from that direction. It may also be expressed in terms of the lumens being emitted or reflected from a perfectly diffusing source. The unit of brightness may be expressed in two ways, Candles per square inch (c/in²) or Footlamberts (ft-L) and is represented by the symbols B or B¹ respectively. *Candles per square inch (c/in)*—A surface emitting or reflecting light in a given direction at the rate of one candle per square inch of projected area has a brightness in that direction of one candle per square inch.

Footlambert (ft-L)—A surface which has a brightness equal to the uniform brightness of a perfectly diffusing surface emitting or reflecting one lumen per square foot has a brightness of one footlambert. The footlambert is also the average brightness of any surface emitting or reflecting light at the rate of one lumen per square foot. The footlambert is the same as the *apparent footcandle*.

REFLECTION FACTOR the ratio of light reflected by the body to the incident light.

TRANSMISSION FACTOR the ratio of the light transmitted by the body to the incident light.

COEFFICIENT OF UTILISATION—The total flux received by the reference plane divided by the total flux from the lamps illuminating it. When not otherwise specified, the plane of reference is assumed to be a horizontal plane 30 inches above the floor.

ROOM INDEX—A factor dependent upon room dimensions, ceiling height and luminaire distribution which takes into consideration the light absorbed by painted surfaces of walls and ceilings.

MAINTENANCE FACTOR—A factor dependent upon local conditions which takes into consideration loss of light through lamp depreciation and accumulation of dirt upon reflecting or transmitting surfaces of the luminaire.

DESIGNING A LIGHTING SYSTEM

This catalogue endeavours to simplify the task of selecting and specifying lighting fixtures for every possible lighting application. Technical data is provided for individual lighting units, together with specifications of the equipment and catalogue information. An appreciation of the technical data given together with an understanding of the basic factors of lighting design will enable the user to solve most ordinary lighting problems.

Technical data for the type of equipment normally used for general lighting purposes is presented in the following manner:—

SHIELDING LENGTHWISE 28° ANGLE CROSSWISE 37°	
SPACING 1.25xMH	EFF 74.5%
M.F.	
G.75	
M.70	
P.65	
CEILING	75% 50%
WALLS	50% 30% 10% 50% 30% 10%
ROOM INDEX	COEFFICIENT OF UTILISATION
J	.27 .26 .22 .24 .22 .21
I	.33 .30 .28 .30 .27 .26
H	.36 .34 .32 .32 .30 .29
G	.40 .37 .35 .36 .33 .31
F	.43 .39 .37 .37 .35 .33
E	.44 .43 .41 .41 .38 .37
D	.49 .46 .43 .43 .41 .39
C	.51 .48 .45 .45 .42 .40
B	.54 .51 .49 .47 .45 .43
A	.55 .53 .51 .48 .46 .45

SHIELDING ANGLE—The shielding angle is given for all units equipped with louvers and indicates the angle of cutoff provided by the type of louvers used.

SPACING—The spacing indicated is that recommended for each particular luminaire. It is related to the mounting height (MH) above the floor for direct, semi-direct and general diffuse luminaires, and to the ceiling height (CH) for indirect and semi-indirect systems. Observance of the spacings recommended will result in uniform illumination throughout the room area. Generally speaking, the distance between luminaires and the wall should not exceed one-half the distance between luminaires, however, when the work area is located very close to the walls, this distance should be reduced to one-third of the distance between luminaires. The height spacing ratios apply equally to continuous rows of fixtures, luminous panels, troughs, etc.

EFFICIENCY—The efficiencies quoted indicate the percentage of bare lamp lumens or the useful light output emitted by the unit. This is also expressed as a percentage of the total light output in the upper and lower hemispheres.

MAINTENANCE FACTOR (M.F.)—The maintenance factor allows for depreciation of lamps and light control elements below initial or design values so that the desired footcandle levels may be maintained in service. The maintenance factors quoted are based upon the following general conditions:



BASIC ILLUMINATION DESIGN DATA

1. GOOD (G)—where work is clean and air is free of fumes or dust, with luminaires scheduled to be cleaned frequently and lamps to be replaced systematically.
2. MEDIUM (M)—where atmospheric conditions in the interior are less favourable, luminaires cleaned at fairly frequent intervals and lamps replaced only after burnout.
3. POOR (P)—quite dirty location and work, with spasmodic or poor maintenance of lighting equipment.

COEFFICIENT OF UTILISATION—The coefficient of utilisation, a factor expressed as a decimal fraction, represents the overall initial efficiency of a lighting system. It includes losses due to (1) the effect of room proportions, (2) absorption of light in the luminaire, and (3) the absorption at various room surfaces. It represents the proportion of generated lamp lumens, which initially reach the specified work surface, both directly from the luminaire and by interreflection.

For all practical purposes, it is only necessary to refer to two prepared tables to obtain the coefficient of utilisation for any given location. The first table takes into consideration the effect of room proportions and this factor is known as the room index. It is determined by the room dimensions and either the mounting height or ceiling height depending upon the general distribution characteristics of the luminaire. Room index tables where applicable are given in the specific design data sections in the catalogue.

Having obtained the room index factor, the appropriate coefficient of utilisation is simply read from the tables given throughout the catalogue as applicable to specific luminaires. These tables account for absorption of light in the luminaire and absorption at various room surfaces.

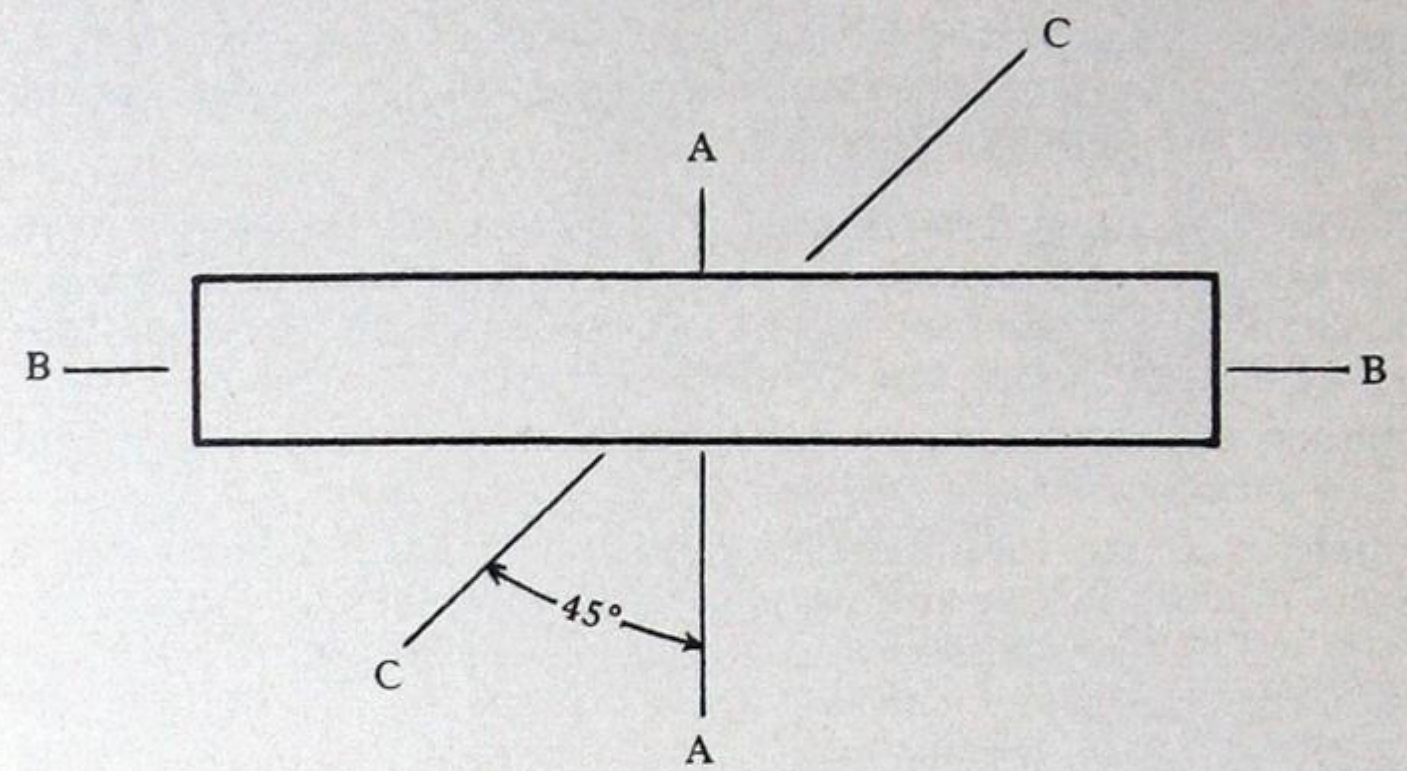

Equipment designed to produce special light distributions of an asymmetric or directional nature are available and are used mainly for specialized applications, such as the lighting of signs, chalkboards, switchboards, corridors, storage bins, etc. It is necessary in illumination design problems of this nature to be able to determine the actual candlepower distribution in a specific direction and to be able to apply these values in illumination design calculations.

LUMINAIRE CLASSIFICATIONS

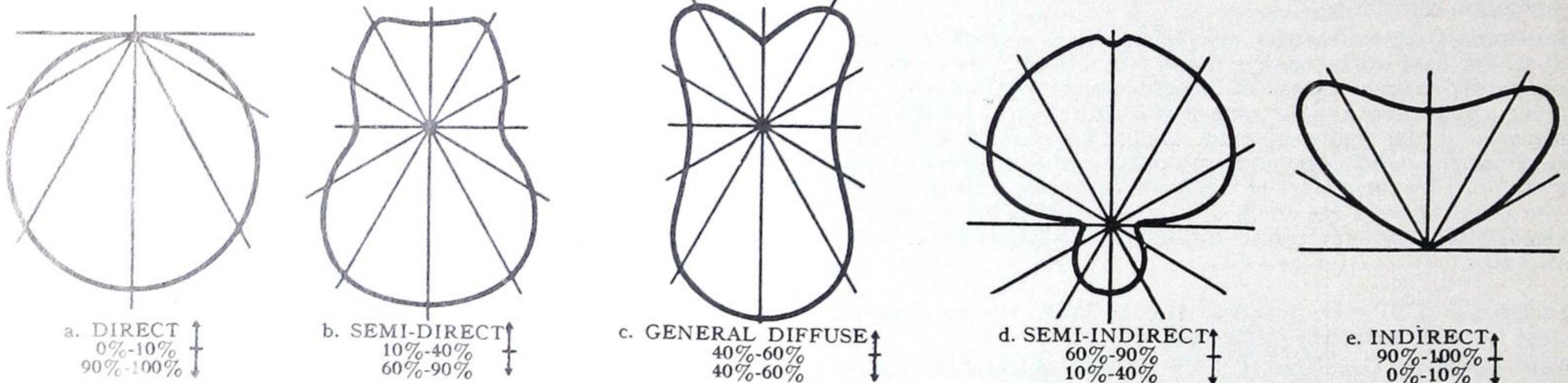

DISTRIBUTION CURVE—The coloured curve superimposed upon the coefficient of utilisation table is a graphical representation of the shape of the light distribution of the particular luminaire.

The various types of lighting units available are designed to produce different types of light distributions, depending upon the purposes for which they are to be used.

All reputable fixture manufacturers have available a complete performance record for each lighting unit manufactured. This performance record is most commonly represented in a form known as the *Candlepower distribution curve* of the unit. The candlepower distribution curve shows graphically and numerically the candlepower distribution of the unit produced in any specific direction, the overall efficiency of the unit as a percentage of the total lamp lumens, the brightness of the exposed surfaces of the unit from different directions and other pertinent data required for illumination design calculations.

For the design of lighting layouts to produce general overall lighting for any specific area, the overall efficiency of the unit, the percentage of light produced in the upper and lower hemispheres and the general shape of the light distribution of the unit, are the important factors. These are shown throughout the catalogue for specific types of lighting equipment to facilitate and simplify the specification of appropriate lighting equipment for any specific application.

The distribution curves for most fluorescent lighting units are taken through separate planes; A. normal or at right angles to the length of the unit; B. parallel with the length of the unit and C. at an angle of 45°. The typical distribution curves shown for fluorescent luminaires in this catalogue are taken normal to the length of the unit.

Technical data for these types of units is therefore shown in the following form.

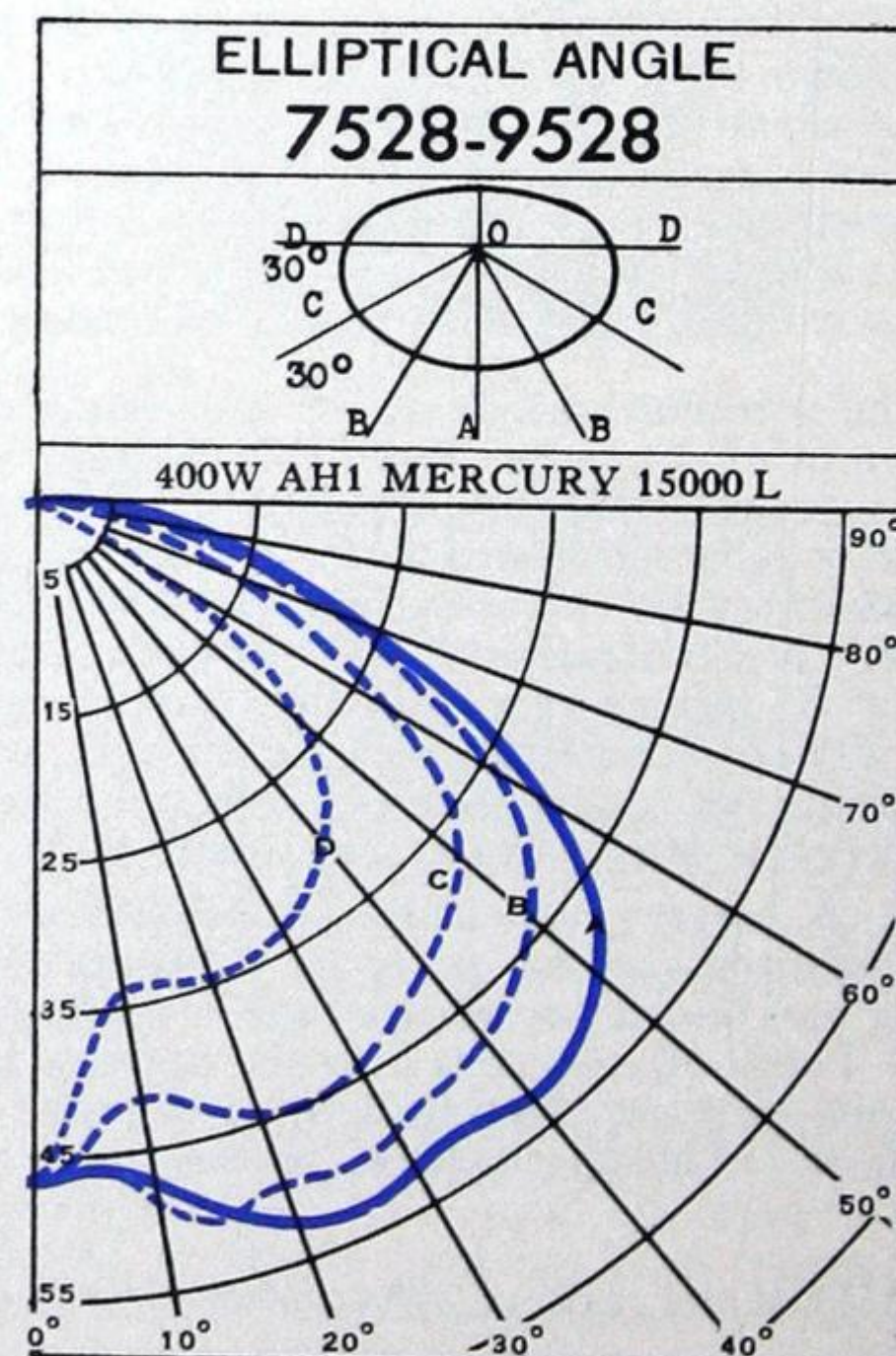

PHOTOMETRIC DATA SHEET NO. 1

Rendered to: Amalgamated Electric Corporation Ltd.
Luminaire: Cat. #92255 with Corning Twin Lens panels
Lamps: Two, 66" T12 type F, Standard Cool White, at 4,00 lumens each
Auxiliary: One, two lamp, 113 volt, 60 cycle, 430 Ma. high power factor

MID-ZONE ANGLE	CANDLEPOWER DATA				ZONAL LUMENS
	0°	45°	90°	AVERAGE FEET	
0° NADIR	2576	2576	2576	2576	—
5°	2564	2574	2584	2574	246
15°	2500	2494	2532	2505	710
25°	2314	2218	2150	2225	1030
35°	2034	1730	1524	1755	1102
45°	1586	1200	1090	1269	981
55°	1044	782	726	834	747
65°	556	456	424	473	469
75°	214	234	236	230	244
85°	44	48	68	52	57
90°	0	0	0	0	—
95°					
105°					
115°					
125°					
135°					
145°					
155°					
165°					
175°					
180° ZEN					

LUMINAIRE FLUX VALUES	
ZONE	% TOTAL LAMP LUMENS
0-30°	1986
0-40°	3088
0-60°	4816
0-90°	5586
0-180°	5586
TOTAL LAMP LUMENS	8800
EFFICIENCY OF LUMINAIRE	63.5%

BRIGHTNESS VALUES		
ZONE	TRANSVERSE	LONGITUDINAL
	MAXIMUM VALUES	
0-45°	1970	1970
45-60°	1732	1620
60-75°	1416	1380
75-90°	798	914
	MINIMUM VALUES	
60-75°	0	0
75-90°	0	0

CEILING	75%			50%			30%		
	50%	30%	10%	50%	30%	10%	50%	30%	10%
WALLS									
ROOM INDEX									
J (0.6)	.35	.32	.31	.34	.32	.31	.32	.30	.30
I (0.8)	.42	.40	.39	.41	.39	.39	.39	.37	.37
H (1.0)	.45	.44	.44	.44	.43	.43	.43	.42	.42
G (1.25)	.49	.47	.47	.48	.46	.45	.46	.45	.45
F (1.5)	.51	.50	.48	.49	.48	.47	.48	.47	.47
E (2.0)	.54	.53	.51	.53	.51	.50	.51	.50	.50
D (2.5)	.57	.55	.53	.55	.54	.53	.53	.53	.53
C (3.0)	.58	.57	.54	.57	.55	.54	.54	.53	.53
B (4.0)	.59	.57	.57	.58	.56	.55	.55	.55	.55
A (5.0)	.60	.58	.58	.58	.57	.56	.57	.57	.55

TESTED BY *E.M.*
CHECKED BY *E.Z.*
APPROVED *J.H.D.*
DATE May 13, 1952.
REPORT NO. 52 - 366
DRAWING NO. RD. 82059-A

PHOTOMETRIC DATA SHEET NO. 2

Rendered to: Amalgamated Electric Corporation Ltd.
Luminaire: Cat. #92255 with Corning Twin Lens panel

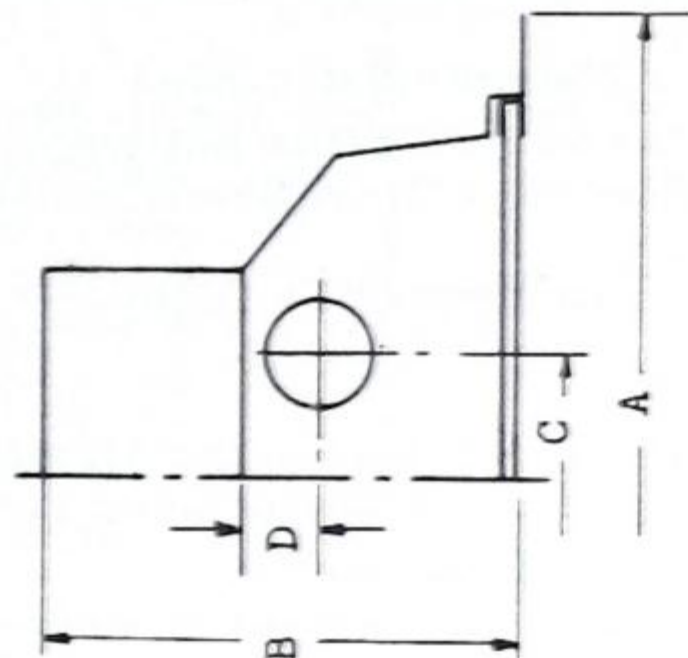

Luminaire finish - White
(Ref. = 85%)

DIMENSIONS	
A	13-3/8
B	6-7/8
C	3-1/2
D	1-1/8
E	
F	

TESTED BY *E.M.*
CHECKED BY *E.Z.*
APPROVED *J.H.D.*
DATE May 13, 1952
REPORT NO. 52 - 366
DWG NO. RD. 82059-B

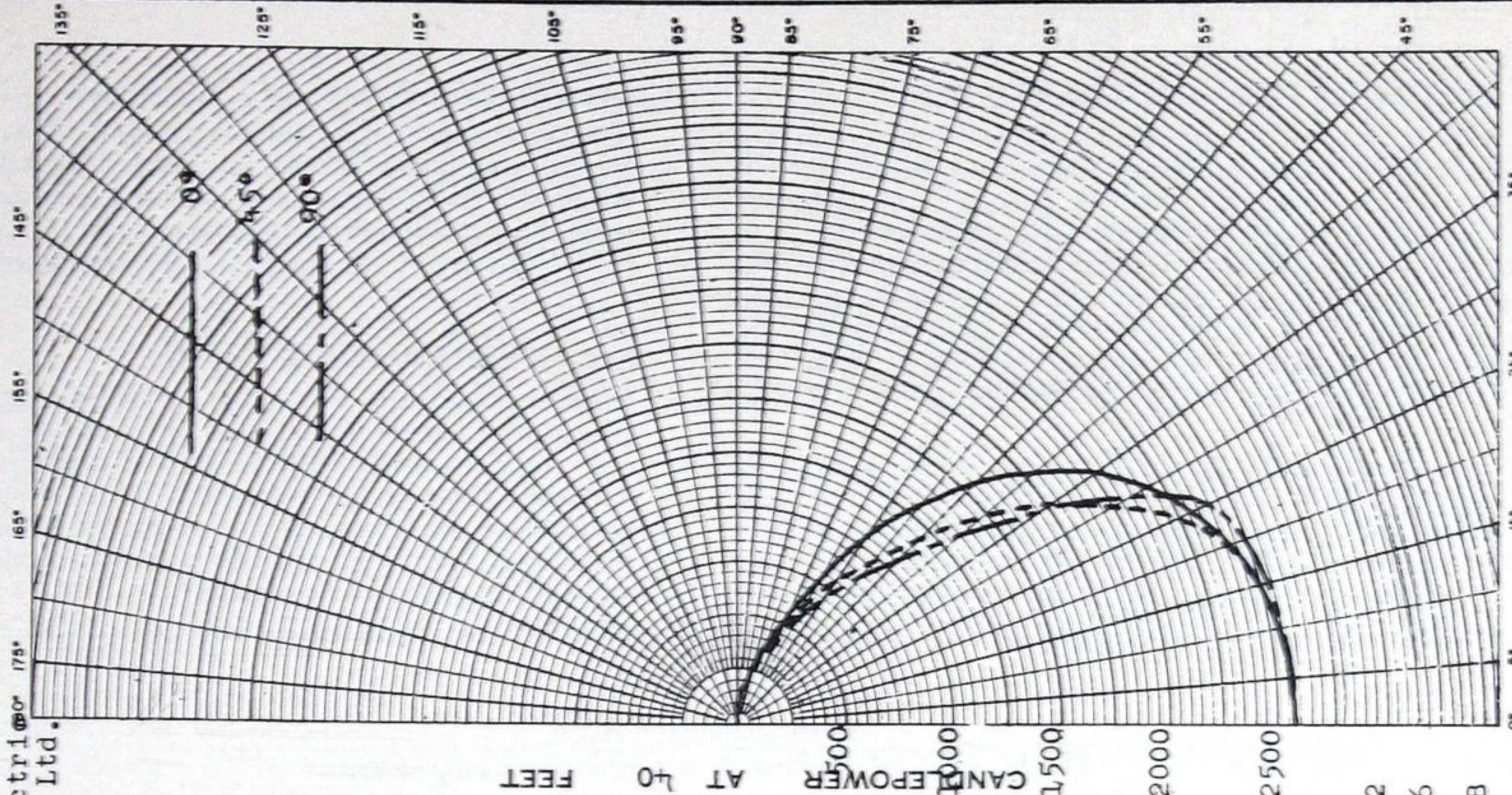



BASIC ILLUMINATION DESIGN DATA

ILLUMINATION CALCULATIONS

It is now a simple matter to use the factors described in the application of the basic formula used in illumination calculations. It must be remembered, however, that the design of a satisfactory lighting installation involves far more than the solving of a simple mathematical equation. All the factors shown in the table given at the beginning of this section and elaborated upon elsewhere in this catalogue, are important. It is strongly recommended that the design data sections relative to industrial and commercial lighting be referred to before preparing any lighting layout.

Two methods of illumination calculations are most commonly used. The lumen method for solving problems involving the provision of a certain average maintained general illumination and the point by point method for solving problems involving the provision of accurate values of illumination at specific points.

Step 4—Co-efficient of Utilisation

This is a ratio of the lumens reaching the working plane and the lumen output of the light source. It takes into consideration efficiency and distribution of the luminaire, reflection factors of walls and ceilings and the room index. Coefficient of utilisation tables are given for specific units throughout the catalogue.

Step 5—Maintenance Factor

When calculating the value of Illumination in lighting design problems, a maintenance factor must be applied to the lighting unit itself, as well as the walls and ceilings. This factor accounts for losses through accumulated dirt on the reflecting and diffusing surfaces of the luminaire and depreciation of light output through the life of the lamp—Maintenance factors are given for specific units throughout the catalogue.

$$\text{Total Lumens} = \frac{\text{Footcandles} \times \text{Area}}{\text{Coefficient of Utilisation} \times \text{Maintenance Factor}}$$

$$\text{Number of Lamps} = \frac{\text{Footcandles} \times \text{Area}}{\text{Lumens per Lamp} \times \text{Coefficient of Utilisation} \times \text{Maintenance Factor}}$$

$$\text{Luminaires} = \frac{\text{Footcandles} \times \text{Area}}{\text{Lamps per Luminaire} \times \text{Lumens per Lamp} \times \text{Coefficient of Utilisation} \times \text{Maintenance Factor}}$$

$$\text{Footcandles} = \frac{\text{Lamp Lumens} \times \text{Coefficient of Utilisation} \times \text{Maintenance Factor}}{\text{Area}}$$

$$\text{Area per Luminaire} = \frac{\text{Lamps per Luminaire} \times \text{Lumens per Lamp} \times \text{Coefficient of Utilisation} \times \text{Maintenance Factor}}{\text{Footcandles}}$$

9

THE LUMEN METHOD—The lumen method involves the application of the basic formulae shown on this page.

When using the lumen method for calculating the average illumination for a given area, seven steps are involved.

Step 1—Determine the required level of Illumination

In both the commercial and industrial design data sections of the catalogue, recommended values of illumination are given for many visual tasks, based upon researches conducted by the Illuminating Engineering Society, an international non-commercial organization, devoted to the art and science of illuminating engineering.

Step 2—Selecting the Lighting System, Luminaire & Lamp

The system may be **GENERAL**—overall lighting. **LOCALIZED**—applying to a specific section of an overall area where higher intensities are required. **LOCAL**—for lighting specific individual seeing tasks, i.e., machines, presses, etc. **SPECIAL**—non-standard applications, special units for inspection purposes, etc.

Luminaires broadly speaking may be (a) direct, (b) semi-direct, (c) general diffuse, (d) semi-indirect, (e) indirect, referring to the type of distribution provided by the luminaire. Commercial applications involve mostly types b, c, d and e. Industrial applications have in the past used mostly type (a) but the present trend toward better quality lighting in industry demands consideration of type (b) semi-direct luminaires to make use of the upward component of light in establishing a better working environment.

Choice will depend upon the specific visual task and the characteristics of the area to be lighted.

Choice of lamp or light source must take into consideration the light output characteristics of the unit. The height spacing ratio, economic factors, maintenance facilities and spectral characteristics.

Step 3—Room Index

Walls and ceilings absorb a percentage of the light delivered from the complete lighting unit. This will depend upon the physical dimensions of the room, mounting height and distribution of the luminaire—Room index tables are given in the commercial and industrial design data sections.

Step 6—Apply Design Formula

Step 7—Determine Location of Luminaires

This will depend upon room function, structural considerations, room proportions, type of luminaires, existing outlets, recommended height spacing ratios, etc.

There are several limitations in using the lumen method of calculation; it should be kept in mind that:

a. It is assumed that recommended height spacing ratios have been maintained to provide reasonable uniformity of light distribution.

b. The standard room index classifications are based on a horizontal work plane, 30 to 36 inches above the floor.

c. The coefficients are based on empty interiors. Large rooms with extensive vertical light obstructions, such as tall machinery, columns, etc., may simulate smaller rooms. The resultant utilisation is lower than indicated by the tables in such cases.

d. The utilisation data is based upon specific conditions of photometry which will vary considerably for individual locations.

e. Conventional coefficients of utilisation are based upon a floor reflectance of 14%. The error with darker floors can ordinarily be neglected. With lighter floors (40% reflectance for example) the error may be 10% or more, depending upon the room proportions and reflection factors.

f. It is assumed that installation conditions are such that lamps will provide the rated lumen output used in the calculations.

Such factors as line voltage at the luminaire, quality of lamps and auxiliary electrical equipment may also affect the ultimate results.

THE POINT BY POINT METHODS—The point by point methods are used to determine accurate illumination values at specific points. Three methods are used depending upon the type of light source; a, point sources, b, line sources and c, surface sources. The point by point method, as applicable to point sources only, will be described in this section, as this is most commonly used.

Since this method does not take into consideration interreflections from room surfaces, the values obtained may be lower than actually realized in practice. It should be remembered also that if the location concerned is lighted by special directional units and is

BASIC ILLUMINATION DESIGN DATA

part of an area receiving illumination from a general lighting layout, as in the case of the lighting of a chalkboard of a classroom, the general lighting will also contribute to the amount of illumination received on that surface.

For practical purposes, where the distance from the source is at least five times the maximum dimensions of the source, the illumination is proportional to the candlepower of the source in a given direction and inversely proportional to the square of the distance from the source.

Footcandles on plane normal to light ray.

$$= \frac{\text{Candlepower of source in direction of ray}}{(\text{Distance in feet from source to plane})^2}$$

If the surface on which the illumination to be determined is tilted, instead of normal to the rays, the light will be spread over a greater area, reducing the illumination in the ratio of the area of plane A to the area of plane B. This ratio is equal to the cosine of the angle of incidence or tilt: thus,

Footcandles on plane B

$$= \frac{\text{CP of source in direction of ray}}{(\text{Distance in feet from source to point in plane})^2} \times \cos \Theta$$

where Θ equals the angle between the light ray and a perpendicular to the plane at that point.

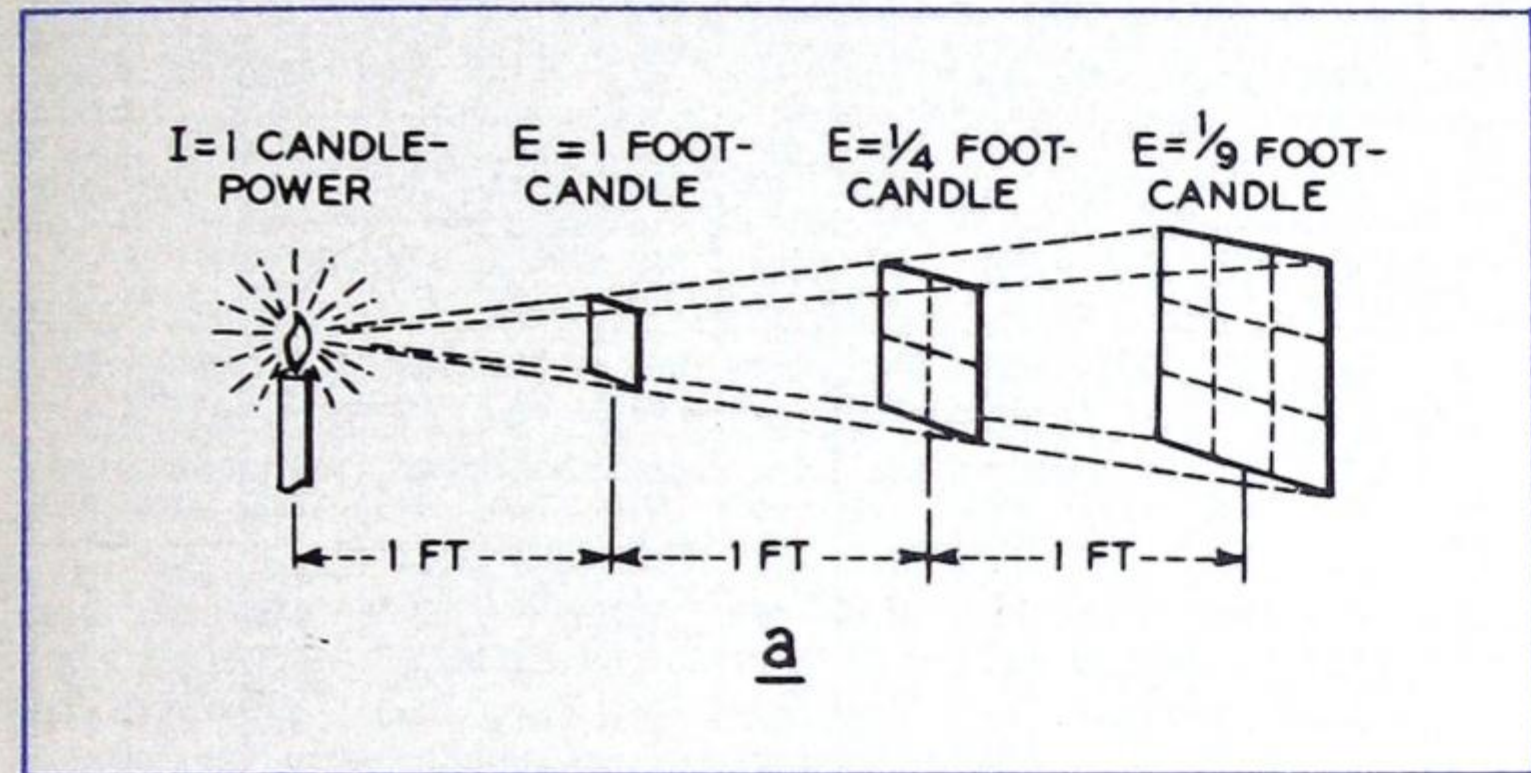

THE INVERSE SQUARE LAW.

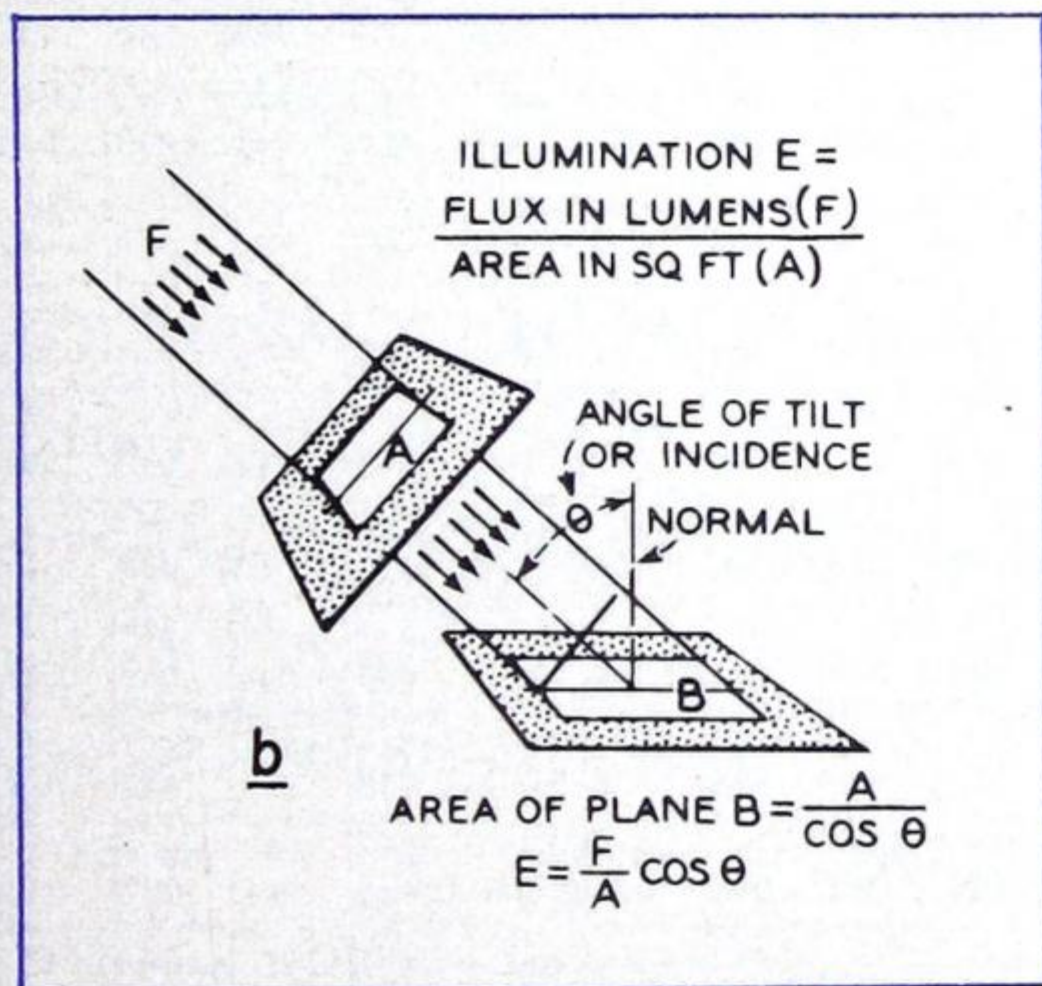

BASIC FORMULA—POINT BY POINT METHOD

H is the vertical mounting height of the light source above the plane of measurement; R is the horizontal distance from the light source to the point whose illumination is being computed; D is the actual distance from the light source to the point; and CP is the candlepower of the light source in the direction of the point (taken from the distribution curve of the unit).

Since $\sin \Theta = \frac{R}{D}$ and $\cos \Theta = \frac{H}{D}$ from the sketches shown the formula for obtaining footcandles on the horizontal and vertical planes may be expressed as follows:—

Footcandles on the horizontal plane

$$\frac{CP \times H}{D^3} = \frac{CP}{D^2} \cos \Theta$$

Footcandles on the vertical plane

$$\frac{CP \times R}{D^3} = \frac{CP}{D^2} \sin \Theta$$

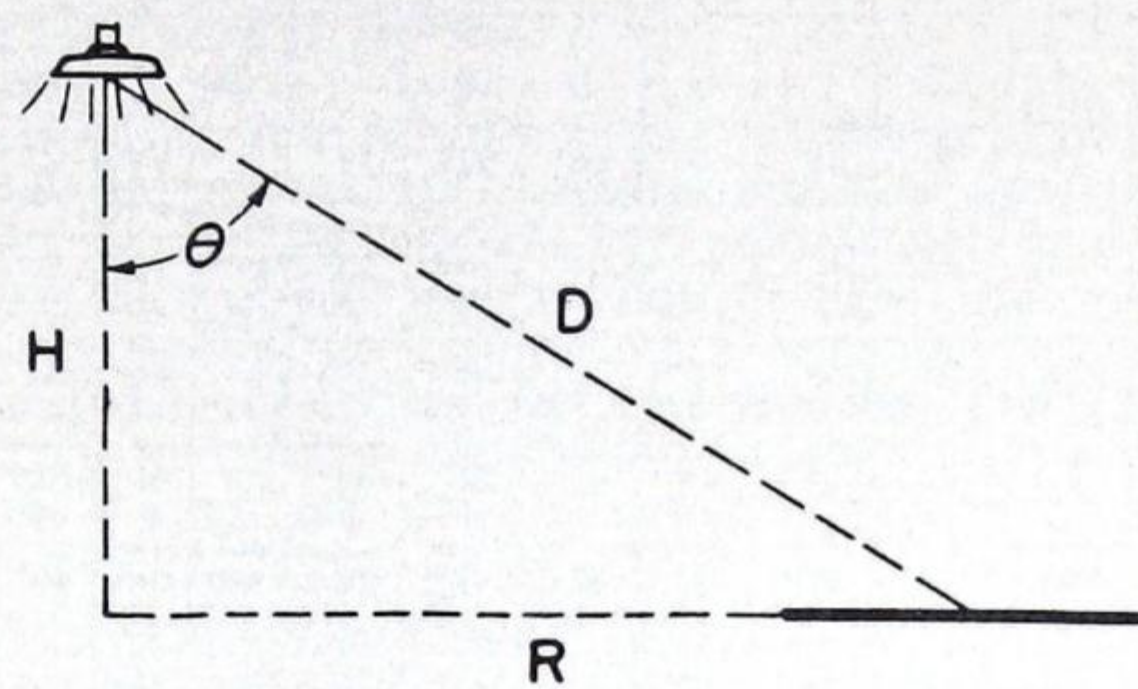

Footcandles (on the horizontal plane)

$$= \frac{\text{Candlepower} \times \cos \Theta}{D^2}$$

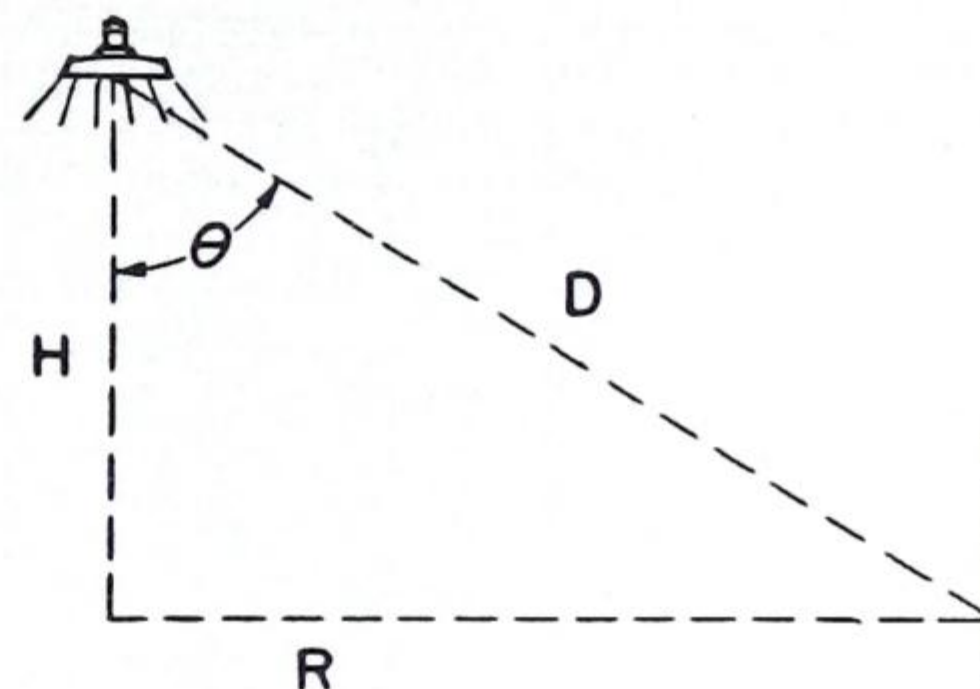

Footcandles (on the vertical plane)

$$= \frac{\text{Candlepower} \times \sin \Theta}{D^2}$$

To facilitate the calculation of horizontal and vertical footcandle intensities, a point by point footcandle calculation table is provided, the use of which requires five simple steps.

Step 1. Determine the mounting height of light source above the horizontal plane.

Step 2. Determine the horizontal distance from the light source to the point whose illumination is being computed.

Step 3. Determine the angle in degrees from the upper figure in appropriate square.

Step 4. Determine from the candlepower distribution curve of the unit the candlepower value in that particular direction.

Step 5. Multiply the candlepower intensity obtained by the multiplying factor, which is the lower figure in the appropriate square, and then divide the result by 100 (The footcandle figures given in the table are for each 100 candlepower of the source in that direction.) The figure thus obtained is the illumination in footcandles at the point.

The table may be used for obtaining footcandles on the vertical plane by using the multiplying factor found when the table headings are reversed i.e. the height of the light source is read on the horizontal distance scale, etc.

MAINTENANCE—maintenance is a most important factor in the effectiveness of any lighting installation. In its broadest sense, it includes everything connected with maintaining the level of illumination of a lighting system as near to its initial value as possible.

Three main factors should be considered:

1. Cleaning of luminaire components.
2. Maintaining correct operating conditions.
3. Lamp replacements.

These three factors are all interrelated and a planned maintenance programme can do much to reduce work stoppage and "slow down" due to the partial ineffectiveness of a good lighting installation brought about by neglect of any one or all of these factors.



Footcandle Calculation Table - Point By Point Method

		Horizontal Distance from Axis of Light Source—Feet*																										
		0	1	2	3	4	5	6	7	8	9	10	11	12	13	14	15	16	18	20	22	24	26	28	30	35	40	50
Height of Light Source Above Surface—Feet.	2	0° 25.000	27° 17.850	45° 8.850	56° 4.275	63° 2.245	68° 1.298	71° .802	74° .528	76° .355	78° .255	79° .190	80° .142	81° .113	81° .090	82° .070	82° .058	83° .048	84° .038	84° .025	85° .020	85° .015	86° .013	86° .008	86° .007	87° .004	87° .000	87° .000
	3	0° 11.110	18° 9.500	34° 6.490	45° 3.933	53° 2.400	59° 1.522	63° 1.000	67° .680	69° .477	72° .356	73° .264	75° .205	76° .161	77° .126	78° .100	79° .084	80° .070	81° .050	81° .036	82° .027	83° .021	83° .016	84° .012	84° .011	85° .007	86° .004	87° .002
	4	0°0' 6.250	14° 5.707	27° 4.472	37° 3.200	45° 2.210	51° 1.524	56° 1.066	60° .764	63° .559	66° .419	68° .320	70° .249	72° .198	73° .159	74° .130	75° .107	76° .090	78° .064	79° .047	80° .037	81° .028	81° .022	82° .018	82° .015	84° .009	84° .006	86° .003
	5	0°0' 4.000	11° 3.771	22° 3.202	31° 2.522	39° 1.904	45° 1.414	50° 1.050	54° .785	58° .595	61° .458	63° .358	66° .283	67° .228	69° .185	70° .152	72° .126	73° .106	74° .077	76° .057	77° .044	78° .034	79° .027	80° .022	81° .017	82° .011	83° .008	84° .004
	6	0°0' 2.778	9° 2.673	18° 2.372	27° 1.987	34° 1.600	40° 1.260	45° .982	49° .766	53° .600	56° .474	59° .378	61° .305	63° .249	66° .205	67° .170	68° .142	69° .120	71° .088	73° .066	75° .051	76° .050	77° .032	78° .026	79° .021	80° .013	81° .009	83° .005
	7	0°0' 2.041	8° 1.980	16° 1.814	23° 1.585	30° 1.336	36° 1.100	41° .893	45° .722	49° .583	52° .473	55° .385	58° .316	60° .261	62° .218	63° .183	65° .154	66° .131	69° .097	71° .074	72° .057	74° .045	75° .036	76° .029	77° .024	79° .016	80° .010	82° .006
	8	0°0' 1.563	7° 1.527	14° 1.427	21° 1.283	27° 1.118	32° .953	37° .800	41° .666	45° .552	48° .458	51° .381	54° .318	56° .267	58° .225	60° .191	62° .163	63° .140	66° .105	68° .080	70° .063	72° .050	73° .040	74° .032	75° .026	77° .018	79° .012	81° .007
	9	0°0' 1.235	6° 1.212	13° 1.148	18° 1.054	24° .943	29° .825	34° .711	38° .607	42° .515	45° .437	48° .370	51° .314	53° .267	55° .228	57° .196	59° .168	61° .146	63° .110	66° .085	68° .067	69° .053	71° .043	72° .035	73° .029	76° .019	77° .013	80° .008
	10	0°0' 1.000	5°43' .985	11° .943	17° .879	22° .801	27° .716	31° .631	35° .550	39° .476	42° .411	48° .354	50° .305	52° .263	54° .227	56° .196	58° .171	61° .149	63° .115	66° .089	67° .071	69° .057	70° .046	72° .038	74° .032	76° .021	77° .014	79° .008
	11	0°0' .826	5°12' .816	10° .787	15° .742	20° .686	24° .623	29° .559	32° .496	36° .437	39° .383	42° .335	45° .292	48° .255	50° .223	52° .195	54° .171	56° .150	59° .117	61° .092	63° .074	65° .060	67° .049	69° .040	70° .034	73° .023	75° .015	78° .009
	12	0°0' .694	4°46' .687	9° .668	14° .634	18° .593	23° .546	27° .497	30° .448	34° .400	37° .356	40° .315	43° .278	45° .246	47° .217	49° .191	51° .169	53° .150	56° .119	59° .094	61° .076	63° .063	65° .051	67° .043	68° .036	71° .024	73° .017	77° .009
	13	0°0' .592	4°24' .587	9° .571	13° .547	17° .517	21° .481	25° .447	28° .404	32° .366	35° .329	38° .295	40° .263	43° .235	45° .209	47° .187	49° .166	51° .148	54° .119	57° .096	59° .078	62° .064	63° .053	65° .044	67° .037	70° .025	72° .017	76° .010
	14	0°0' .510	4°5' .506	8° .495	12° .477	16° .454	20° .426	23° .396	27° .365	30° .334	33° .304	36° .275	38° .248	41° .223	43° .201	45° .180	47° .162	49° .146	52° .118	55° .096	58° .079	60° .065	62° .054	63° .046	65° .039	68° .026	71° .018	75° .011
	15	0°0' .444	3°49' .442	8° .433	11° .419	15° .401	18° .380	22° .356	25° .331	28° .305	31° .280	34° .256	36° .233	39° .212	41° .192	43° .174	45° .157	47° .142	50° .117	53° .096	56° .079	58° .066	60° .055	62° .047	63° .040	67° .027	69° .019	73° .011
	16	0°0' .391	3°35' .388	7° .382	11° .371	14° .357	17° .339	21° .321	24° .300	27° .280	29° .259	32° .238	35° .219	37° .200	39° .183	41° .167	43° .152	45° .138	48° .115	51° .095	54° .080	56° .067	58° .056	60° .048	62° .041	66° .028	68° .020	72° .012
	17	0°0' .346	3°22' .344	7° .339	10° .331	13° .319	16° .306	19° .290	22° .274	25° .256	28° .239	30° .222	33° .205	35° .189	37° .174	39° .159	41° .146	43° .134	47° .112	50° .094	52° .079	55° .069	57° .057	59° .048	60° .042	64° .029	67° .021	71° .012
	18	0°0' .309	3°11' .307	6° .303	9° .297	13° .287	16° .276	18° .264	21° .250	24° .236	27° .221	29° .206	31° .192	34° .178	36° .165	38° .152	40° .140	42° .129	45° .109	48° .092	51° .079	53° .067	55° .057	57° .049	59° .042	63° .030	66° .021	70° .012
	19	0°0' .277	3°1' .276	6° .273	9° .267	12° .260	15° .251	18° .240	20° .229	23° .217	25° .205	28° .192	30° .180	32° .167	34° .156	36° .145	38° .134	40° .124	43° .106	46° .090	49° .077	52° .066	54° .057	56° .049	58° .042	62° .030	65° .022	69° .013
	20	0°0' .250	2°51' .249	5°43' .246	9° .242	11° .236	14° .228	17° .219	19° .210	22° .200	24° .190	27° .179	29° .168	31° .158	33° .147	35° .137	37° .128	39° .119	42° .103	45° .088	48° .076	50° .066	52° .057	54° .049	56° .043	60° .030	63° .022	68° .013
	21	0°0' .227	2°44' .226	5°26' .224	8° .220	11° .215	13° .210	16° .201	18° .194	21° .185	23° .176	25° .167	28° .158	30° .144	32° .139	34° .131	36° .122	37° .114	41° .099	44° .086	46° .075	49° .065	51° .056	53° .049	55° .043	59° .030	62° .022	67° .013
	22	0°0' .207	2°36' .206	5°10' .205	8° .201	10° .196	13° .192	15° .185	18° .179	20° .171	22° .164	25° .155	27° .148	29° .140	31° .132	33° .124	34° .114	36° .109	39° .096	42° .084	45° .073	47° .064	50° .056	52° .049	54° .043	58° .031	61° .023	66° .014
	23	0°0' .189	2°29' .189	4°58' .187	7° .184	10° .181	12° .176	15° .171	17° .165	19° .159	21° .153	24° .146	26° .139	28° .132	29° .125	31° .118	33° .111	35° .105	38° .092	41° .081	44° .071	46° .063	49° .055	51° .049	53° .043	57° .031	60° .023	65° .014
	24	0°0' .174	2°23' .173	4°45' .172	7° .170	10° .166	12° .163	14° .158	16° .154	18° .148	21° .143	23° .137	25° .130	27° .124	28° .118	30° .112	32° .106	34° .100	37° .089	40° .079	43° .070	45° .061	47° .054	49° .048	51° .042	56° .031	59° .024	64° .014
	25	0°0' .160	2°17' .160	4°34' .158	7° .157	9° .154	11° .151	14° .147	16° .143	18° .138	20° .133	22° .128	24° .123	26° .117	27° .112	29° .106	31° .101	33° .096	36° .086	39° .076	41° .068	44° .060	46° .053	48° .047	50° .042	55° .031	58° .024	63° .015
	27	0°0' .137	2°7' .137	4°14' .136	6° .135	8° .133	10° .130	12° .128	15° .124	17° .121	18° .117	20° .113	22° .109	24° .105	26° .100	27° .096	29° .092	31° .087	34° .079	37° .071	39° .064	42° .057	44° .051	46° .046	48° .041	52° .031	56° .024	62° .015
30	0°0' .111	1°54' .111	3°50' .111	5°43' .109	8° .108	9° .107	11° .105	13° .103	15° .100	17° .098	18° .095	20° .092	22° .089	23° .086	25° .083	27° .080	28° .077	31° .070	34° .064	36° .058	39° .053	41° .048	43° .043	45° .039	49° .031	53° .024	59° .015	
33	0°0' .092	1°44' .092	3°28' .091	5°12' .091	7° .090	9° .089	10° .087	12° .086	14° .084	15° .082	17° .080	18° .078	20° .076	22° .074	23° .072	24° .069	26° .067	29° .062	31° .058	34° .053	36° .049	38° .045	40° .041	42° .037	47° .030	50° .024	57° .015	
36	0°0' .077	1°36' .077	3°11' .077	4°46' .076	6° .076	8° .075	9° .074	11° .073	13° .072	14° .070	16° .069	17° .067	18° .066	20° .064	21° .062	23° .061	24° .059	27° .055	29° .052	31° .048	34° .044	36° .041	38° .038	40° .034	44° .029	48° .023	54° .015	
40	0°0' .063	1°26' .062	2°52' .062	4°17' .062	5°43' .062	7° .061	9° .060	10° .060	11° .059	13° .058	14° .057	15° .056	17° .055	18° .054	19° .053	21° .051	22° .050	24° .047	27° .045	29° .042	31° .039	33° .037	35° .034	37° .032	41° .027	45° .021	51° .013	
45	0°0' .049	1°16' .049	2°33' .049	3°49' .049	5°5' .049	6° .049	8° .048	9° .048	10° .047	11° .047	13° .046	14° .045	15° .045	16° .044	17° .043	18° .042	20° .041	22° .040	24° .038	26° .036	28° .034	30° .032	32° .030	34° .028	38° .022	42° .016	48° .008	
50	0°0' .040	1°9' .040																										



BASIC ILLUMINATION DESIGN DATA

BASIC DESIGN DATA

Cleaning of Luminaire Components and Light Sources—The engineering of quality lighting equipment takes into consideration ease of maintenance. Reflecting, diffusing and optical elements are often made so that they can be completely removed and replaced by a cleaned component. It is simple and economical to carry a small quantity of extra components for this purpose. Permanent parts are made easily accessible for cleaning purposes and louvers or diffusing glass panels hinged for easy access to the lamps.

Maintaining Correct Operating Conditions—It is important that lamps and electrical accessories be of the correct rated voltage and that the rated voltage be maintained at the light source, if the equipment is to operate at maximum efficiency and full life is to be obtained from the lamps.

For fluorescent luminaires, automatic or manual reset starters are recommended for preheat-starting circuits. The constant on-and-off characteristic of lamp failures when the standard type starter is used may result in damage to the lamp ballast and is annoying to persons working in the area.

LAMP REPLACEMENTS—For smaller installations, it may suffice to replace lamps that have failed or are reaching the end of their useful life, as and when this condition becomes obvious. For larger installations, however, it is often desirable to maintain a specific schedule of lamp replacement to minimize labour costs and interference with the normal operations of the particular area. Such a programme, known as the group replacement system, may be based on a periodic check and replacement programme or on a scheduled replacement of all lamps in a particular area, regardless of their apparent operating or appearance characteristics. The group replacement programme is based upon the premise that the saving in cost of replacing lamps is greater than the value of the remaining light output in a large group of lamps after a certain number of hours operation.

QUALITY OF LIGHTING

The quality of any lighting installation or the degree of visual comfort attained depends on a number of factors which are difficult to evaluate. The most important factor, however, is glare (the sensation experienced by an observer when brightness relationships in the field of view cause discomfort or the inability to see properly). Generally speaking, glare is classified as *discomfort glare* or *disability glare*.

DISCOMFORT GLARE—The conditions under which the brightness contrasts or relationships do not necessarily interfere with seeing but under which the eye cannot operate efficiently or comfortably.

DISABILITY GLARE—The condition under which the brightness contrasts or relationships create conditions which interfere with the process of seeing.

In modern interior lighting practice, discomfort glare is likely to be more of a problem than disability glare. Discomfort glare may be *direct* due to too bright or insufficiently shielded light sources or sources of too great an area in the field of view, or *reflected* due to annoying specular reflection from sources which are in themselves too bright or wrongly placed.

The control of glare may be achieved by the use of louvers, diffusing media or by prismatic glassware. The degree of glare which may be expected from a light source or luminaire may be judged to some extent from the brightness of the exposed surfaces. The evaluation of this factor by the brightness of the unit, however, considers the individual light source or luminaire only and is no criterion for the evaluation of the degree of comfort of the entire lighting system under consideration.

It is now possible to establish the *glare rating* or the *degree of comfort* for any interior lighting installation by a process developed within the last few years and known as the glare factor system.

GLARE FACTORS—The glare factor system of evaluating lighting installations is based upon the additive effect of multiple sources. For most lighting installations such calculations become long and laborious, however, it is possible to prepare glare rating or glare factor tables for specific luminaires and room conditions for easy reference. Such tables are already available and examples are given on following pages.

The formula on which these factors are based provide that a glare factor of unity will be found for a source of one square inch having a brightness of 1000 footlamberts when viewed at a distance of 10 feet and at an angle of 10 degrees above the horizontal line of sight, the background being a uniform field of 10 footlamberts.

Experience with the glare factor system has led to the following tentative evaluations:—

a, GLARE FACTOR 0-10—Not likely to be criticized because of discomfort.

b, GLARE FACTOR 10-15—Few if any people will find such an interior lacking in comfort, unless it is necessary for them to constantly look upward toward the luminaires. Fifteen is considered the upper limit for complete comfort for people working in a fixed position for long periods.

c, GLARE FACTOR 15-25—Some people will find such rooms slightly annoying if engaged in critical work for long periods. This range is usually satisfactory where occupants change activities and locations at intervals of an hour or so.

d, GLARE FACTOR 25-40—Where quality lighting is desired and critical work is concerned, this range should not be exceeded. Such values are indicated for large rooms with 75 footcandle installations with an indirect lighting system and where some persons are constantly aware of the large ceiling area.

For industrial applications involving fine bench work, but requiring less mental concentration than clerical work, this range may also be considered satisfactory.

e, GLARE FACTOR 40-100—Industrial (factory) installations considered to be good lighting practice fall in this range when the average worker is moving about frequently. The more demanding the type of work, the lower the glare factors should be.

The Northern Electric Lighting Service is at your disposal for advice in solving any of your lighting problems, or for the preparation of complete lighting layouts—

CONSULT YOUR LOCAL NORTHERN ELECTRIC OFFICE

GLARE FACTOR EVALUATION CHART

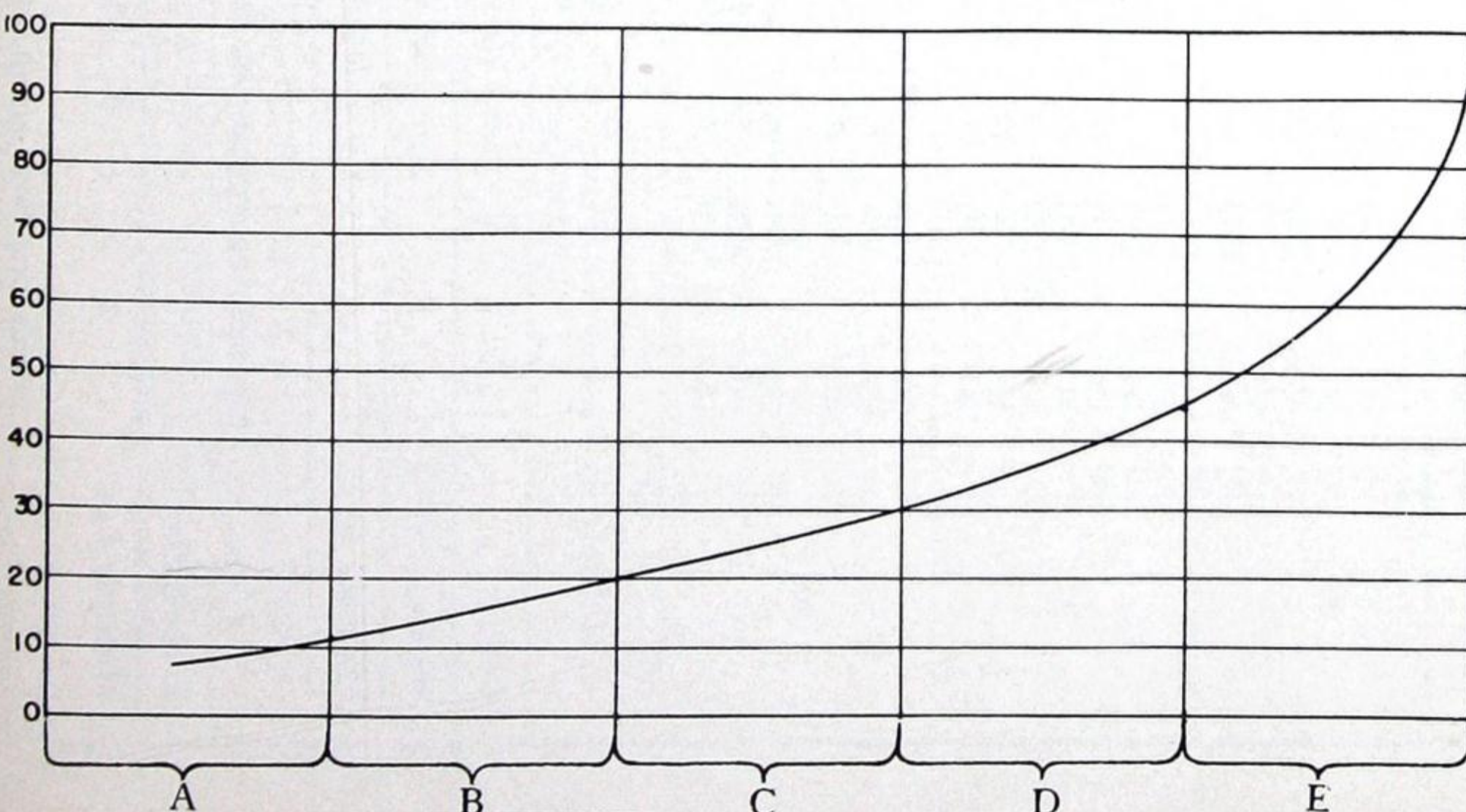

- A.—Few or no complaints, comfortable for all.
- B.—Practical average comfortable for most occupants.
- C.—Average borderline for offices, schools, etc. (Do not exceed 40).
- D.—Approximately $\frac{1}{2}$ of the occupants may complain of discomfort.
- E.—Approximately $\frac{3}{4}$ of the occupants may complain of discomfort.



BASIC ILLUMINATION DESIGN DATA

Table A-4. Provisional Glare Factors for 40-Footcandle Installations of Diffusing Globes of 1500 Footlamberts Brightness

Ceiling 75 Per Cent RF; Walls 50 Per Cent RF; Working Plane 15 Per Cent RF



ROOM WIDTH	ROOM LENGTH	HEIGHT ABOVE FLOOR (Feet)			
		8	9	10	12
10	10	55	30	22	5
	15	100	60	50	20
	20	140	100	75	35
	30	220	140	110	65
	60	260	170	140	85
15	10	70	40	27	7
	15	120	80	60	26
	20	170	110	90	45
	30	250	170	130	80
	60	320	240	170	100
20	10	80	50	34	10
	20	190	130	100	55
	30	280	200	150	90
	40	360	260	200	120
	80	480	360	280	180
30	10	100	55	38	13
	20	240	150	120	65
	30	340	230	180	120
	40	420	300	250	160
	100	580	440	350	240
40	10	110	60	40	15
	20	250	170	130	75
	30	360	260	200	140
	40	460	340	260	200
	100	760	600	500	420

Multiplying Factors for Above Table to Correct for Other Wall and Ceiling Reflectances at 40 Footcandles

Ceiling	75			50			30			
	50	30	10	50	30	10	50	30	10	
Walls	1.0	1.2	1.55	1.2	1.5	1.8	1.2	1.5	1.8	2.3
Multiply by:	1.0	1.2	1.55	1.2	1.5	1.8	1.2	1.5	1.8	2.3

Multiplying Factors for Other Footcandle Levels

Footcandles	1	2	3	5	10	15	20	30	40	50	60	80	100
Multiply by:	.2	.3	.4	.45	.55	.7	.75	.9	1.0	1.1	1.15	1.3	1.4

Illuminating Engineering Society Lighting Handbook, 2nd Edition.

Table A-5. Provisional Glare Factors for 40-Footcandle Indirect Installations of Silvered-Bowl Lamps in Shallow Reflectors. Average Ceiling Brightness about 100 Footlamberts*

Ceiling 75 Per Cent RF; Walls 50 Per Cent RF; Working Plane 15 Per Cent RF

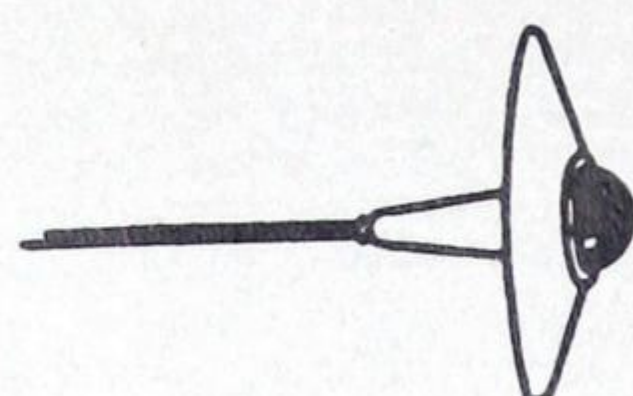

ROOM WIDTH	ROOM LENGTH	CEILING HEIGHT (Feet)			
		9	10	12	14
10	10	3	2	1	1
	15	6	3	2	1
	20	7	5	3	2
	30	8	6	5	2
	60	8	7	6	3
15	10	5	3	2	1
	15	8	6	3	2
	20	9	7	5	3
	30	11	8	6	3
	60	13	11	7	5
20	10	5	3	2	2
	20	8	7	5	3
	30	11	9	7	5
	40	12	11	7	5
	80	13	12	10	7
30	10	6	5	3	2
	20	9	8	6	3
	30	11	10	7	5
	40	12	11	8	6
	100	14	13	11	8
40	10	6	5	3	2
	20	10	8	6	3
	30	11	10	8	5
	40	12	11	9	6
	100	14	13	11	8

This table applies for ceiling brightness uniformity of the order of 2.5-1; typical of silvered-bowl lamp installations. If ceiling brightness is distinctly nonuniform, of the order of 5-1, increase the values in the table by multiplying by 1.2. Glare factors for indirect lighting contain no allowance for ceiling beams or ceiling area obscured by luminaires.

Multiplying Factors for Above Table to Correct for Other Wall and Ceiling Reflectances at 40 Footcandles

Ceiling	75			50			30		
	50	30	10	50	30	10	50	30	10
Walls	1.0	1.3	1.8	1.0	1.3	1.8	1.0	1.3	1.8
Multiply by:	1.0	1.3	1.8	1.0	1.3	1.8	1.0	1.3	1.8

Multiplying Factors for Other Footcandle Levels

Footcandles	20	30	40	50	60	80	100
Multiply by:	.40	.65	1.00	1.35	1.75	2.70	3.60

* Ceiling brightness may vary considerably depending on room proportions



BASIC ILLUMINATION DESIGN DATA

Table A-6. Provisional Glare Factors for 40-Footcandle Installations of Fluorescent Luminares Having Four Lamps Inside a Diffusing Half-Cylinder 12 Inches in Diameter and 48 Inches Long (Closed Top)
Ceiling 75 Per Cent RF; Walls 50 Per Cent RF; Working Plane 15 Per Cent RF

ROOM WIDTH	ROOM LENGTH	HEIGHT ABOVE FLOOR (Feet)											
		8		9		10		12					
		Units End-wise	Units Cross-wise	Units End-wise	Units Cross-wise	Units End-wise	Units Cross-wise	Units End-wise	Units Cross-wise	Units End-wise	Units Cross-wise		
10	10	21	50	12	28	10	15	12	28	10	15		
	15	27	90	18	60	16	38	16	60	16	38		
	20	30	130	21	80	17	55	17	80	17	55		
	30	30	170	22	120	19	80	19	110	19	110		
	40	31	200	23	150	19	110	20	150	20	150		
	60	32	260	23	180	20	150						
15	10	30	55	21	33	13	19	13	33	13	19		
	15	35	100	26	80	19	44	19	80	19	44		
	20	38	140	30	90	24	65	24	90	24	65		
	30	41	200	32	140	29	110	29	110	29	110		
	40	42	250	35	180	31	130	31	130	31	130		
	60	43	320	36	240	34	180	34	180	34	180		
20	10	38	60	28	35	17	21	17	35	17	21		
	20	47	150	39	100	31	70	31	100	31	70		
	30	56	200	42	160	36	120	36	120	36	120		
	40	55	260	45	200	39	150	39	150	39	150		
	60	55	350	47	260	42	200	42	200	42	200		
	80	55	440	47	320	43	260	43	260	43	260		
30	10	55	65	39	37	26	24	26	37	26	24		
	20	70	160	55	110	44	80	44	110	44	80		
	30	75	230	60	180	50	130	50	130	50	130		
	40	80	300	60	240	50	180	50	180	50	180		
	60	85	400	65	300	55	250	55	250	55	250		
	80	85	500	70	380	55	300	55	300	55	300		
40	10	85	560	70	450	55	340	55	340	55	340		
	20	105	600	90	480	75	400	75	400	75	400		
	30	105	600	90	480	75	400	75	400	75	400		
	40	105	600	90	480	75	400	75	400	75	400		
	60	105	600	90	480	75	400	75	400	75	400		
	80	105	600	90	480	75	400	75	400	75	400		



Multiplying Factors for Above Table to Correct for Other Wall and Ceiling Reflectances at 40 Footcandles

Ceiling	75		50		30	
Walls	50	30	10	50	30	10
Multiply by:	1.0	1.2	1.55	1.2	1.5	1.8

Multiplying Factors for Other Footcandle Levels

Footcandles	1	2	3	5	10	15	20	30	40	50	60	80	100
Multiply by:	.2	.3	.4	.45	.55	.7	.75	.9	1.0	1.1	1.15	1.3	1.4

Illuminating Engineering Society Lighting Handbook, 2nd Edition.

Table A-7. Provisional Glare Factors for 40-Footcandle Installations of Single-Lamp 40-Watt Etched Aluminum Troffers with Crosswise Louvers: Shielding 45 Degrees Crosswise, 25 Degrees Longitudinal
Ceiling 75 Per Cent RF; Walls 50 Per Cent RF; Working Plane 15 Per Cent RF (See Note Below)

ROOM WIDTH	ROOM LENGTH	CEILING HEIGHT (Feet)											
		8		9		10		12					
		Units End-wise	Units Cross-wise	Units End-wise	Units Cross-wise	Units End-wise	Units Cross-wise	Units End-wise	Units Cross-wise	Units End-wise	Units Cross-wise		
10	10	23	6	20	6	14	5	23	6	20	6		
	15	26	6	25	6	23	5	26	6	25	6		
	20	26	6	26	6	25	5	26	6	26	6		
	30	26	6	26	6	26	5	26	6	26	6		
	40	26	6	26	6	26	5	26	6	26	6		
	60	26	6	26	6	26	5	26	6	26	6		
15	10	23	8	20	7	14	6	23	8	20	7		
	15	26	8	25	7	24	6	26	8	25	7		
	20	26	8	26	7	25	6	26	8	26	7		
	30	26	8	26	7	26	6	26	8	26	7		
	40	26	8	26	7	26	6	26	8	26	7		
	60	26	8	26	7	26	6	26	8	26	7		
20	10	23	8	20	8	14	7	23	8	20	8		
	20	26	8	26	8	25	7	26	8	26	8		
	30	26	8	26	8	26	7	26	8	26	8		
	40	26	8	26	8	26	7	26	8	26	8		
	60	26	8	26	8	26	7	26	8	26	8		
	80	26	8	26	8	26	7	26	8	26	8		
30 and 40	20	26	8	26	8	25	8	26	8	26	8		
	30	26	8	26	8	26	8	26	8	26	8		
	40	26	8	26	8	26	8	26	8	26	8		
	60	26	8	26	8	26	8	26	8	26	8		
	80	26	8	26	8	26	8	26	8	26	8		
	100	26	8	26	8	26	8	26	8	26	8		



Note: if the average reflectance of the working plane and floor is 30 per cent instead of 15 per cent, decrease the values in above table by 30 per cent. Similarly, if the ceiling has depreciated to one-half of the 75 per cent reflectance, increase the values in the table by 30 per cent.

Multiplying Factors for Other Footcandle Levels

Footcandles	1	2	3	5	10	15	20	30	40	50	60	80	100
Multiply by:	.2	.3	.4	.45	.55	.7	.75	.90	1.00	1.1	1.15	1.30	1.4

LITERATURE ON ALL ASPECTS OF LIGHTING PROBLEMS

AVAILABLE FROM
THE ILLUMINATING ENGINEERING SOCIETY
 1860 BROADWAY NEW YORK 23, N.Y.

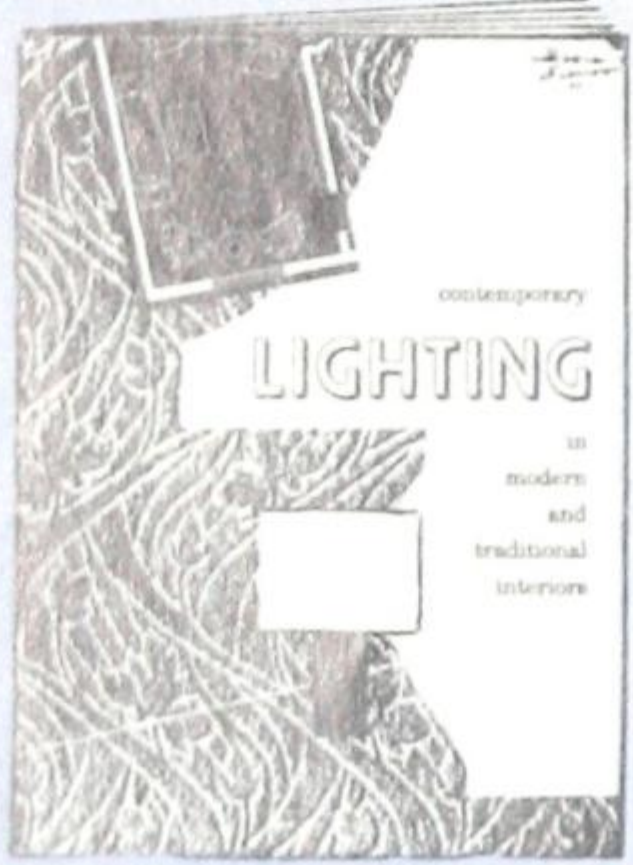
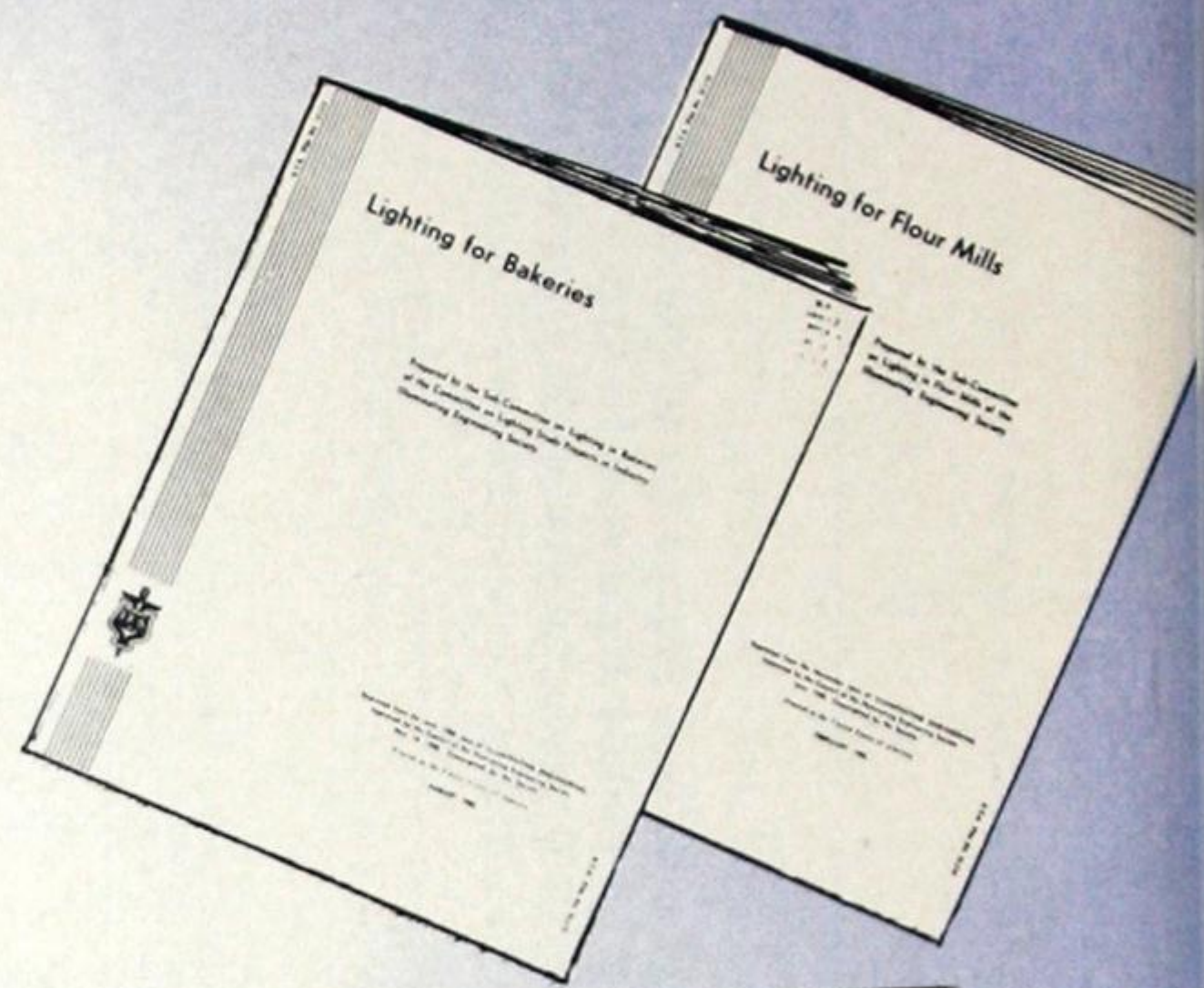
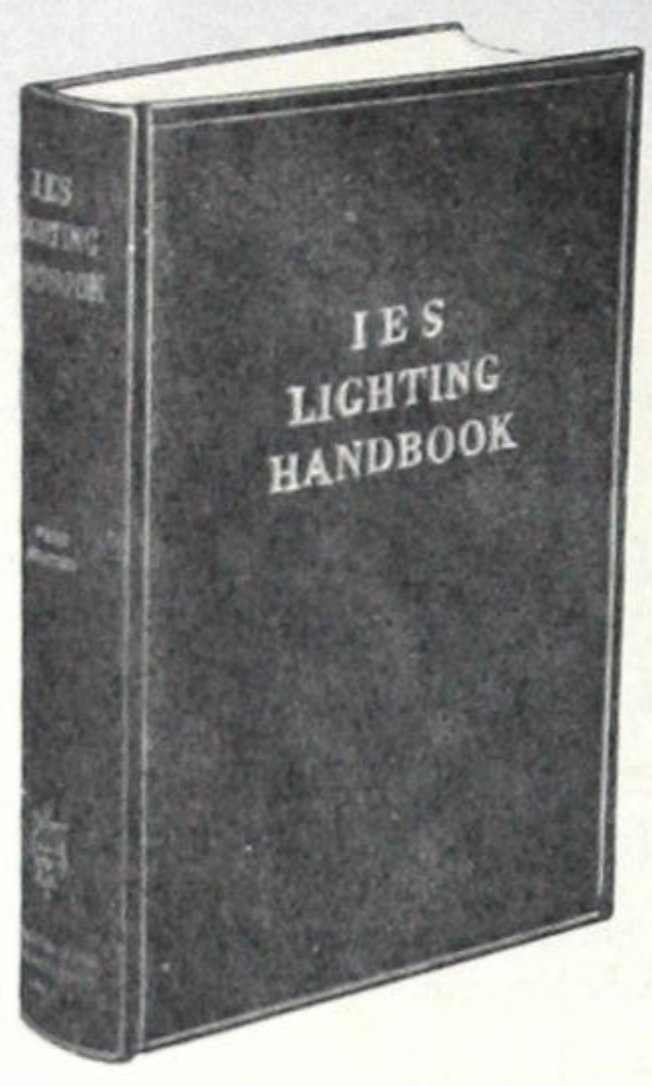

The Northern Electric Company offers a complete Dominion wide lighting service. This service is based upon standards established by the Illuminating Engineering Society, an international, non-commercial organization devoted to the art and science of Illuminating Engineering.

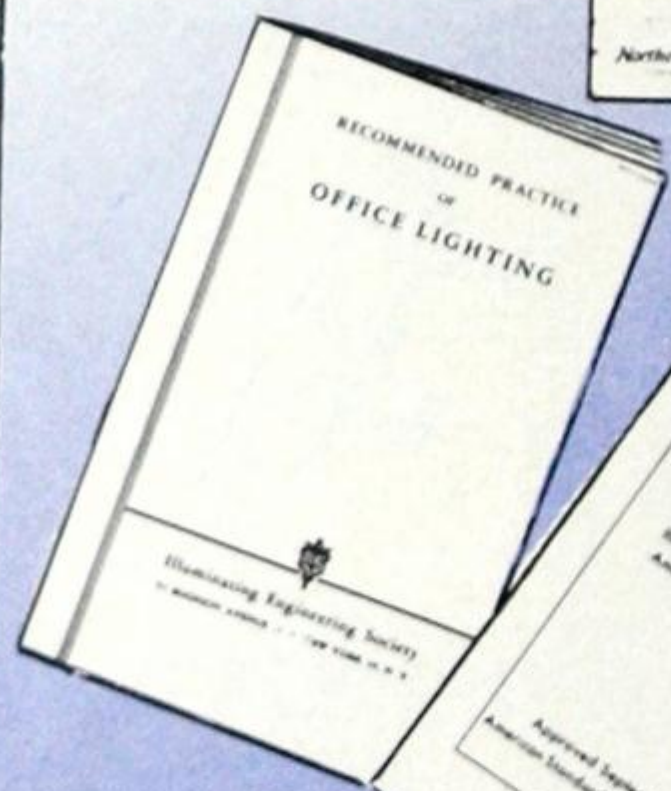
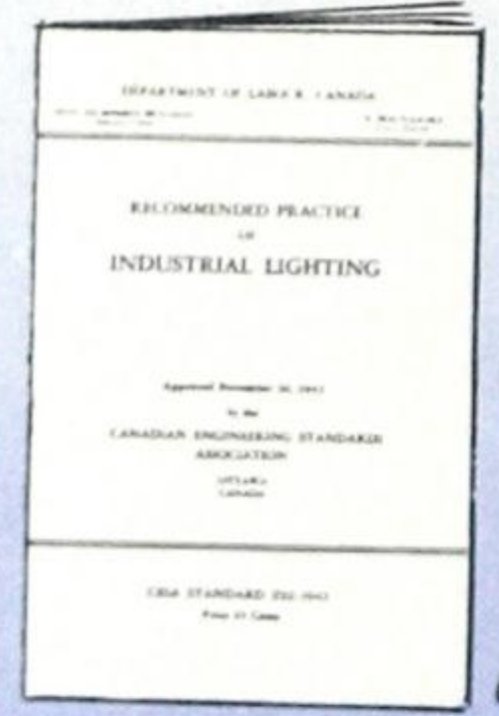
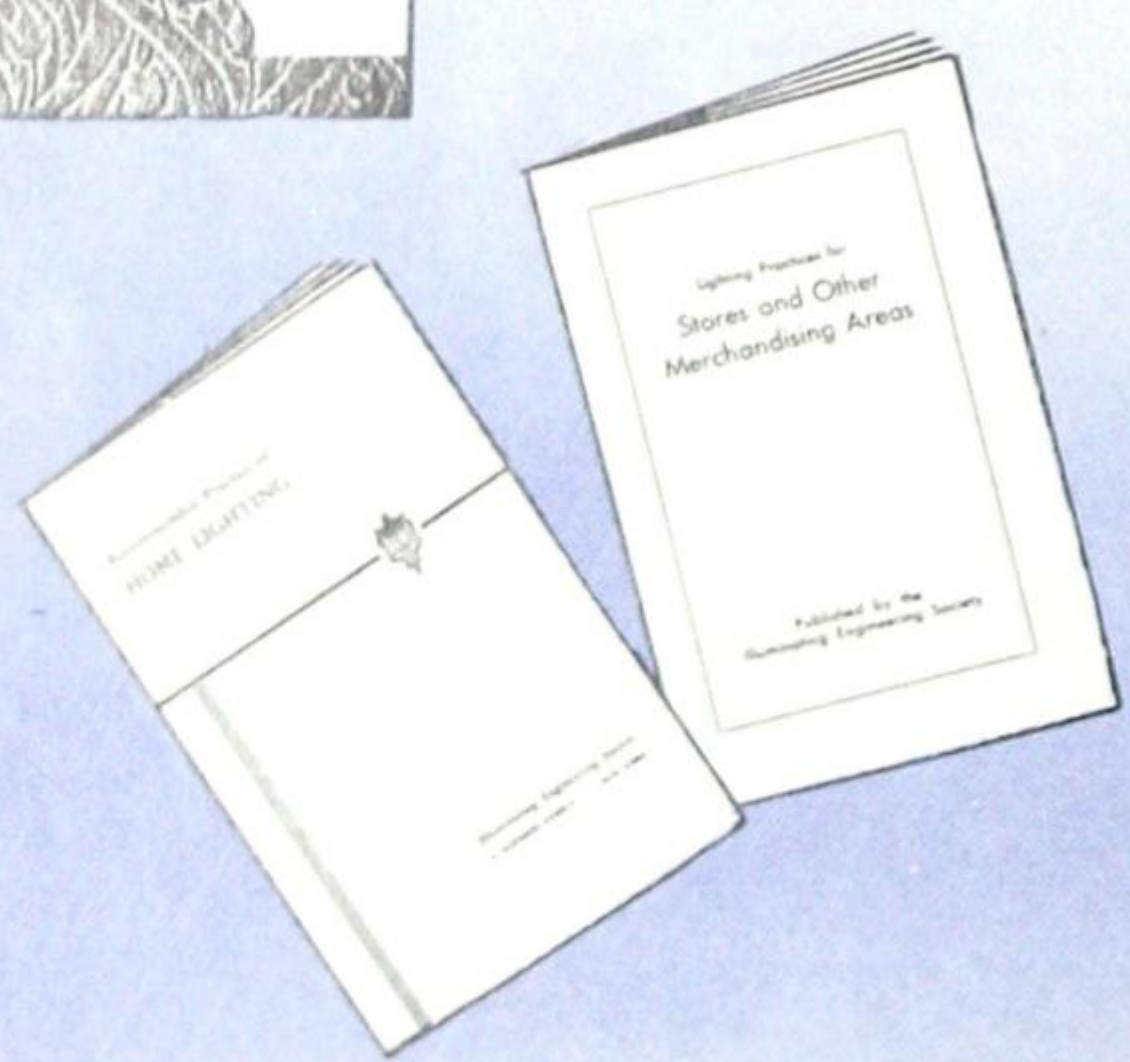
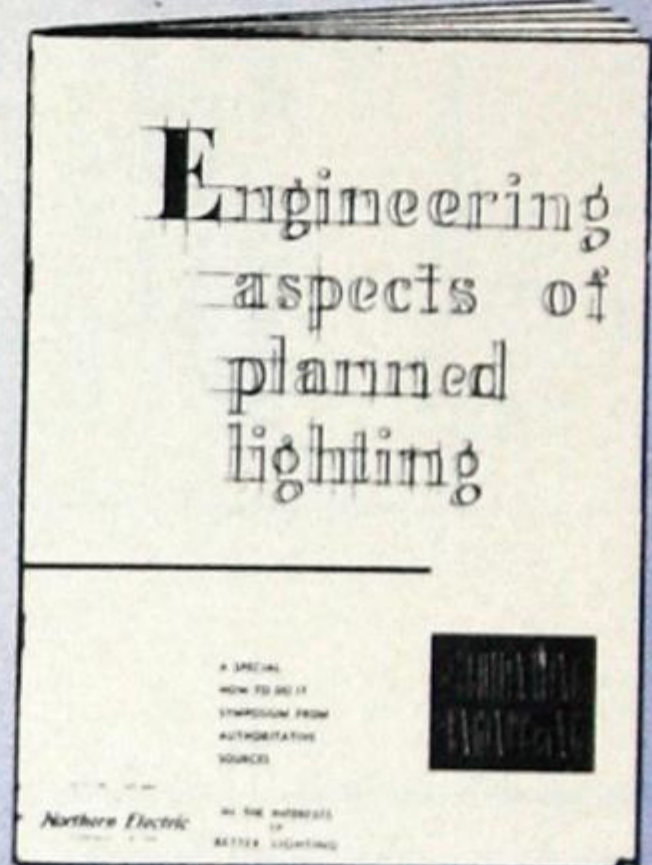

THE SERVICES OF EXPERIENCED LIGHTING ENGINEERS ARE AT YOUR DISPOSAL — CONSULT YOUR LOCAL NORTHERN ELECTRIC OFFICE

Use the
Northern Electric Lighting Service

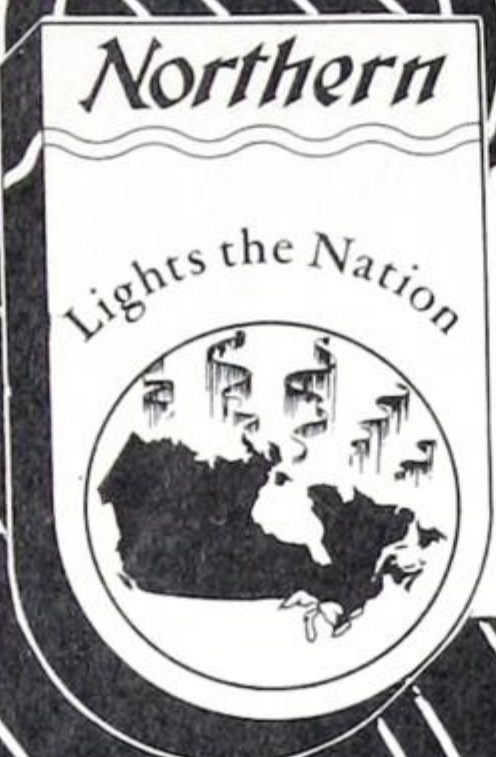
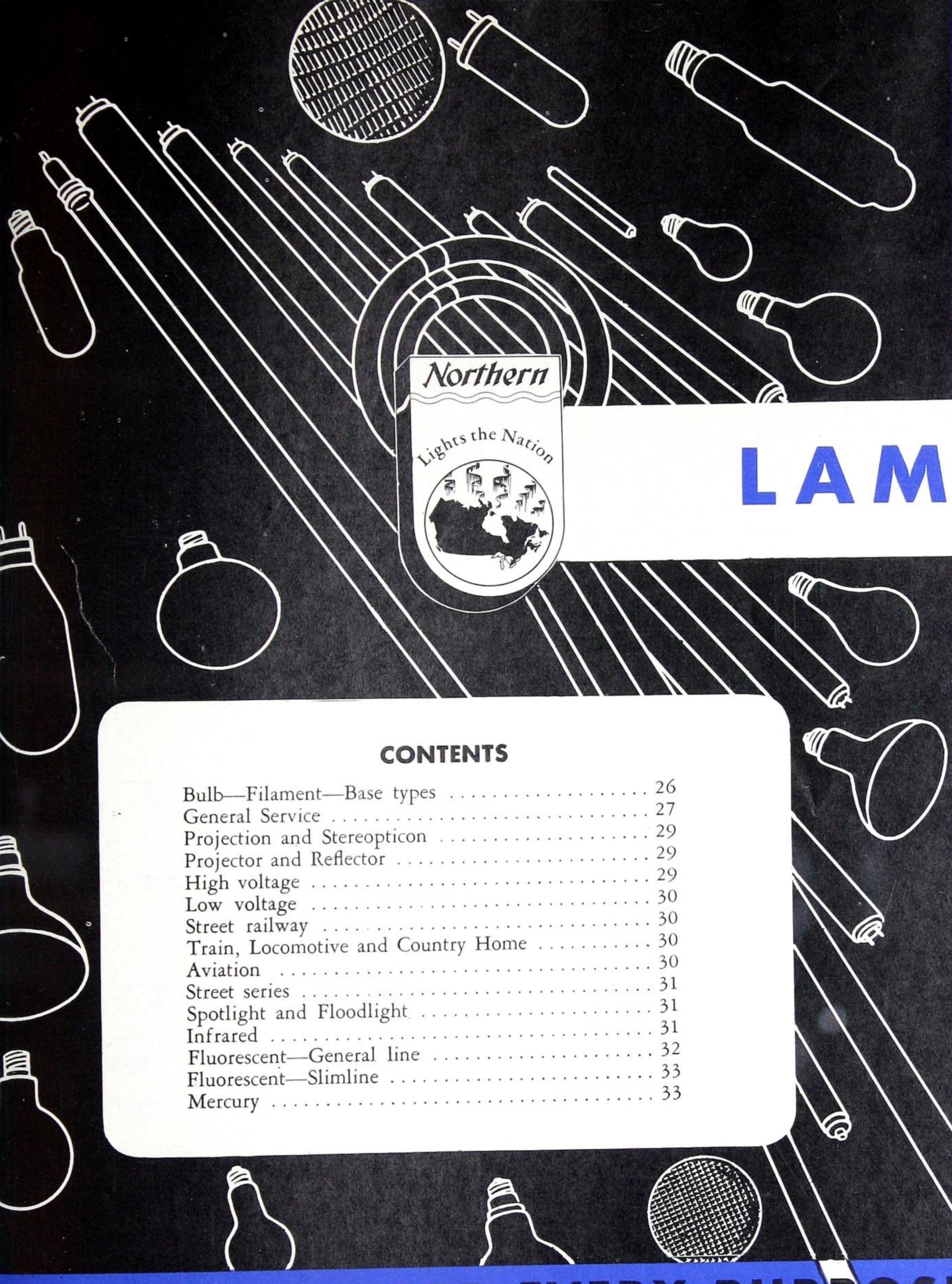

LAMPS

CONTENTS

Bulb—Filament—Base types	26
General Service	27
Projection and Stereopticon	29
Projector and Reflector	29
High voltage	29
Low voltage	30
Street railway	30
Train, Locomotive and Country Home	30
Aviation	30
Street series	31
Spotlight and Floodlight	31
Infrared	31
Fluorescent—General line	32
Fluorescent—Slimline	33
Mercury	33

G.E. LAMPS FOR EVERY PURPOSE

DISTRIBUTED BY

Northern Electric

COMPANY LIMITED



BULB—FILAMENT—BASE TYPES

Bulb Designations

Bulb Designations consist of a letter to indicate its shape and a figure to indicate the approximate diameter in eighths of an inch. Over-all Length is measured from top of bulb to bottom of base. Light Center Length is measured from the center of the filament to bottom of screw bases; top of base pins or fins of bayonet or pre-focused bases; shoulder of post of mogul bipost bases and bottom of bulb (base end) for medium bipost bases.

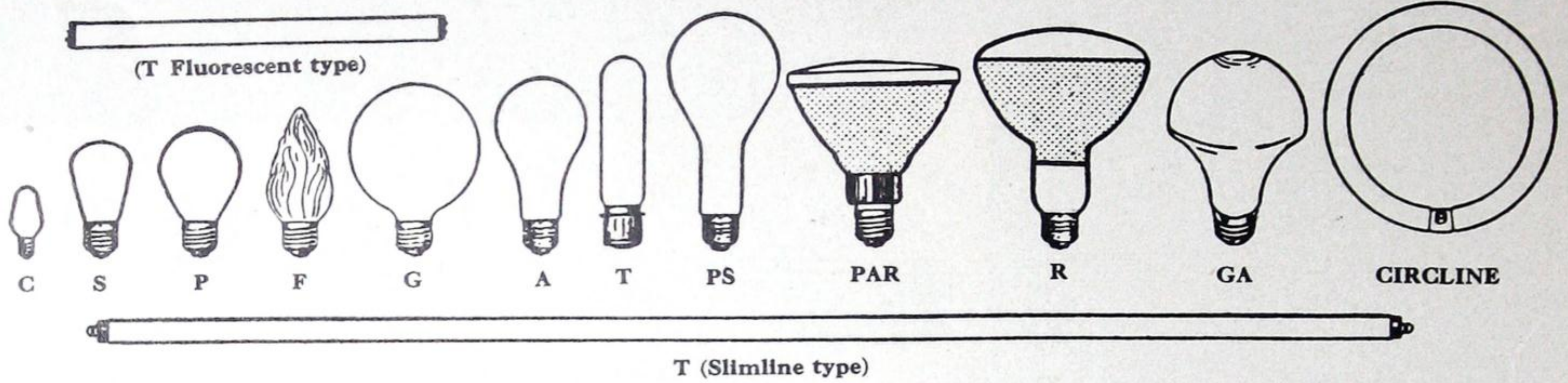

Filament Designations

Filament Designations consist of a prefix letter to indicate whether the wire is straight or coiled, and a number to indicate the arrangement of the filament on the supports. Prefix letters include: S (straight)—wire is straight or slightly corrugated; C (coiled)—wire is wound into a helical coil or it may be deeply fluted; CC (coiled coil)—wire is wound into a helical coil and this coiled wire again wound into a helical coil. Shapes of filaments are shown below.

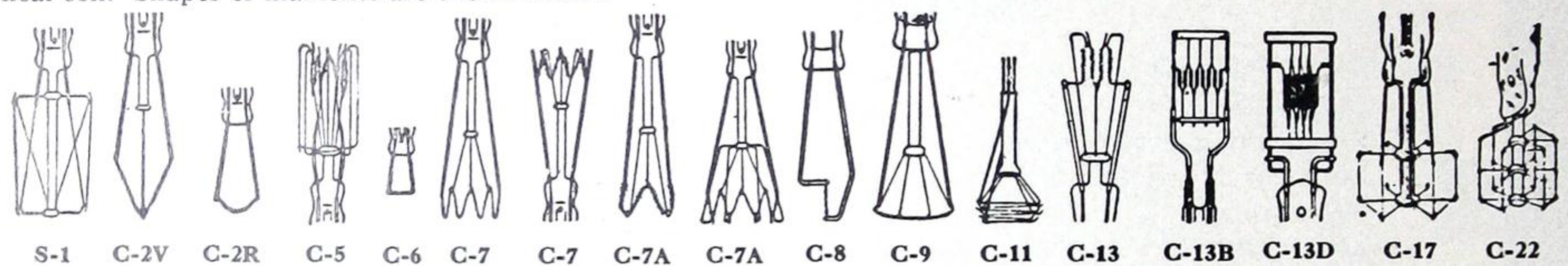

Lamp Bases

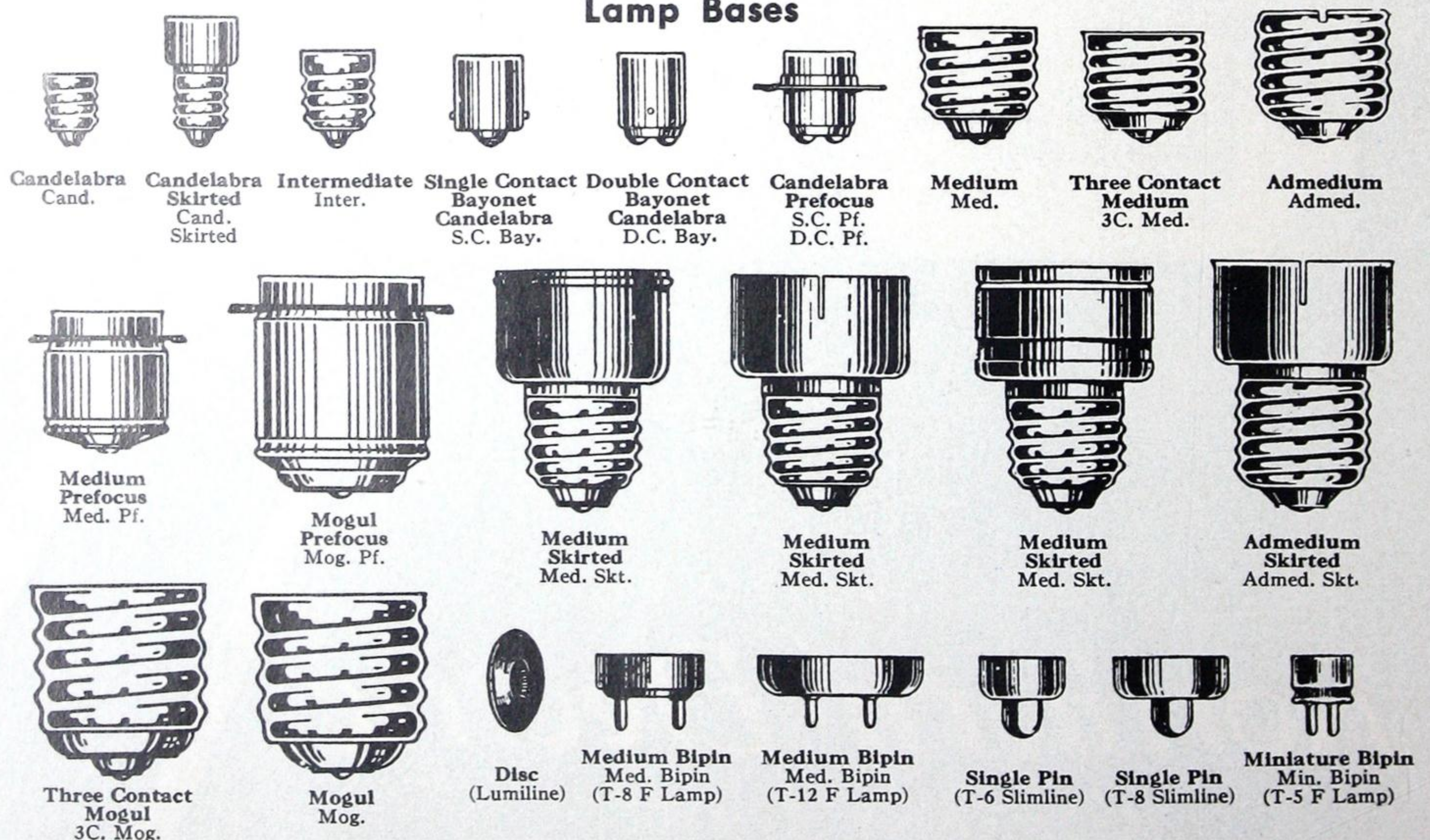

(Base illustrations approximately half scale)



INCANDESCENT LAMPS

General Electric Lamps for General Service

Watts	Volts	Bulb	Base	Finish, Description, etc.	Lamp Ordering Abbreviation (Except Volts)	Std. Pkg. Qty.	Rated Initial Lumens	Max. Over-all Length (Ins.)	Average Light Centre Length (Ins.)	Position of Burning
50	110-115, 115-120	A-19	Med.	I.F. Rough Service.....	50A/RS	120	455	3 1/8	2 1/2	Any
				Clear Milltype.....	C50A/MT		540			
	115-120 (only)	GA-25		Semi. Ind. I.F. Enam. Bowl.....	50GA	60		4 1/8		B. U.
	50 100 150	110, 115, 120	PS-25	3 cont. Med.	I.F. 3-Lite.....	50/150M/1		{ 550 1420 1970 }	5 1/8	3 3/8
I.F. 3-Lite.....					50/150		{ 550 1420 1970 }	6 1/8	5	
50 100 150	110, 115, 120	R-40	3 cont. Mog.	White Indirect 3-Lite.....	50/150R/W			6 1/8		B. D.
60	115-120 (only)	A-19	Med.	Yellow.....	60A/Y	120		4 7/8		Any
	110-115, 115-120	A-19		I. F. Coiled Coil.....	60A		780	4 7/8	3 3/8	
	110-115, 115-120	A-19	Med.	White.....	60A W			4 7/8		B.D.
	110, 115, 120			Clear Traffic Signal.....	60A21/TS		660	4 7/8	2 7/8	to H
	115-125 (only)			Daylight I. F.....	60A21/D		545	4 1/8	3 3/8	Any
	110-115, 115-120 120 (only)	T-8	Disc.	I. F. Bowl Reflector.....	C60A1SB					
				White Lumiline.....	L60/W	24		17 3/4		
100	115-120 (only)	A-21	Med.	Yellow.....	100A21/61Y	120		5 1/8		Any
	110-115, 115-120 (only)	A-21		I. F.—750 hr. Coiled Coil.....	100A		1520	5 1/8	3 3/8	
	110-115, 115-120	A-21		I. F.—1000 hr. Coiled Coil.....	100A21/61		1480	5 1/8	3 3/8	
	110-115, 115-120	A-21		White.....	100A/W			5 1/8		
	115-125 (only)			Clear.....	C100A23		962			
	110-115, 115-120			Daylight I. F.....	C100A/D					
	110, 115, 120			I. F. Bowl Reflector.....	C100A/SB					B. U.
				I. F. Rough Service.....	100A/RS		1150			Any
				I. F. Vibration.....	100A23/28		1300			Vert.
			PS-30		I. F. Neck Reflector.....	C100/RN	60		8 1/8	
100 200 300		G-30	3 cont. Mog.	White 3-Lite Indirect.....	100/300	24	{ 1380 3300 4680 }	6 3/4		B. D.
150	110, 115, 120 (only)	PS-25	Med.	Clear—750 hr.....	150/CL	60	2550	6 1/8	5 1/4	Any
	110, 115, 120			I. F. —750 hr.....	150					
				Clear—1000 hr.....	150PS25		2460			
	115-125 (only)			I. F. —1000 hr.....	150PS25/IF					
	110, 115, 120			Daylight Clear.....	150/DCL		1680			
	120 (only)			I. F. Bowl Reflector.....	150/SB					B. U.
110, 115, 120	PS-30		Yellow.....	150PS25/Y					Any	
110, 115, 120	R-40	Med.	I. F. Neck Reflector.....	C150/RN			8 1/8			
				White Indirect.....	150R/W			6 1/8		B. D.
200	110, 115, 120 (only)	PS-30	Med.	Clear—750 hr.....	200	60	3560	8 1/8	6	Any
	110, 115, 120			I. F. —750 hr.....	200/IF					
				Clear—1000 hr.....	200PS30/28		3400			
	115-125 (only)			I. F. —1000 hr.....	200PS30/29					
	110, 115, 120	PS-35		Daylight Clear.....	200/D		2380			
				I. F. Bowl Reflector.....	200/SB IF					B. U.
				I. F. Neck Reflector.....	C200/RN	24		8 3/4		Any
300	110, 115, 120 (only)	PS-30	Med.	Clear—750 hr.....	300M	60	5730	8 1/8	6	Any
	110, 115, 120			I. F. —750 hr.....	300M/IF					
				Clear—1000 hr.....	300M/1		5510			
	115-125 (only)	PS-35	Mog.	I. F. —1000 hr.....	300M/1/IF					
	110, 115, 120			Clear —1000 hr.....	300	24		9 3/8	7	
				I. F. —1000 hr.....	300/IF		3650			
			Daylight Clear.....	300/D						
		PS-40		I. F. Bowl Reflector.....	300/SB IF					B. U.
				I. F. Neck Reflector.....	C300/RN	24		9 3/4		Any
500	110, 115, 120	PS-40	Mog.	Clear.....	500	24	9750	9 3/4	7	Any
				I. F.....	500/IF					
	115-120 (only)			Daylight Clear.....	500/D		6450			
	110, 115, 120			I. F. Bowl Reflector.....	500/SB IF					B. U.
750	110, 115, 120	PS-52	Mog.	Clear.....	750	6	15,500	13 1/8	9 1/2	Any
				I. F.....	750/IF					
				I. F. Bowl Reflector.....	750/SB IF					B. U.
1000	110, 115, 120	PS-52	Mog.	Clear.....	1000	6	21,500	13 1/8	9 1/2	Any
				I. F.....	1000/IF					
				I. F. Bowl Reflector.....	1000/SB IF					B. U.
1500	110, 115, 120	PS-52	Mog.	Clear.....	1500	6	33,000	13 1/8	9 1/2	Any
				I. F.....	1500/IF					



INCANDESCENT LAMPS

General Electric Lamps For Projection and Stereopticon Service

Watts	Volts	Bulb	Base	Finish, Description, etc.	Lamp Ordering Abbreviation (Except Volts)	Std. Pkg. Qty.	Rated Initial Lumens	Max. Over-all Length (Ins.)	Average Light Centre Length (Ins.)	Position of Burning
100	110, 115, 120	T-8	S.C. Bay.	Clear—CC-2V fil.....	100T8/108SC	24	1950	3 1/8	1 3/8	Base Down or can be burned within 25 degrees of vertically base down without materially affecting performance
150	110, 115, 120	T-8	S.C. Bay.	Clear.....	150T8/70	24	3300	3 5/8	1 3/8	
+200	110, 115, 120	T-8 T-10#	S.C. Bay. Med. Pref.	Clear.....	200T8/SC 200T10P	24	4700 4250	3 5/8 5 3/4	1 3/8 2 1/8	
+300	110, 115, 120	T-10#	Med. Pref.	Clear (opaque end)—2CC-8 fil.....	300T10P	24		5 3/4	2 1/8	
+500	110, 115, 120	T-10# T-20#	Med. Pref.	Clear (opaque end)..... Clear.....	500T10P 500T20P	24 6	13,200	5 3/4	2 1/8	
+750	110, 115, 120	T-12#	Med. Pref.	Clear (opaque end).....	750T12P	24		5 3/4	2 1/8	
+1000+	110, 115, 120	T-12# T-20#	Med. Pref. Mog. Pref.	Clear (opaque end)—10 hr. life..... 25 hr. life..... Clear—C-13 fil.....	1M/T12P 1M/T12/46 1M/T20P	24 6	28,000	5 3/4 9 1/2	2 1/8 3 1/8	

+Should be used only in equipment that provides adequate forced cooling. #Heat-resisting glass bulb.

General Electric Projector and Reflector Lamps

Watts	Bulb	Base	Finish, Description, etc.	Lamp Ordering Abbreviation (Except Volts)	Std. Pkg. Qty.	Max. Over-all Length (Ins.)	Approx. Initial Zone Lumens	Initial Max. Beam C.P.*
75	R-30	Med.	Light I. F. Reflector Spot..... I. F. Reflector Flood.....	75R30/SP 75R30/FL	60	5 1/8	200 (0-15°) 275 (0-30°)	1,840 840
150	PAR-38§ R-40+ +	Med. Skt.† Med.	Projector Spot..... Flood..... Light I. F. Reflector Spot..... I. F. Reflector Flood.....	150PAR/SP 150PAR/FL 150R/SP 150R/FL	12 24	5 1/8 6 1/2	1150 (0-15°) 1400 (0-30°) 550 (0-15°) 735 (0-30°)	12,000 3,500 6,430 1,285
200	R-40+ +	Med.	Light I. F. Reflector Spot..... I. F. Reflector Flood.....	200R/SP 200R/FL	24	6 1/2	735 (0-15°) 900 (0-30°)	8,450 1,760
300	R-40+ +	Med.	Light I. F. Reflector Spot..... I. F. Reflector Flood.....	300R/SP 300R/FL	24	6 1/2	1240 (0-15°) 1470 (0-30°)	14,700 2,575
500	R-40+ +	Mog.	Light I. F. Reflector Spot I. F. Reflector Flood.....	500R/3SP 500R/3FL	24 24	7 1/4 7 1/4		
500	R-52	Mog.	Light I. F. — High Bay.....	500R52	6	11 3/4	3500 (0-30°)	4,000
750	R-52	Mog.	Light I. F. — High Bay.....	750R52	6	11 3/4	5300 (0-30°)	6,000

†Should be burned only in porcelain sockets. *For satisfactory performance, no accessory equipment should be attached to, or touch, the glass bulb.
§Heat-resisting glass bulb—for outdoor or indoor use. #At distance of 10 feet.

General Electric Lamps For High Voltage Service

Watts	Volts	Bulb	Base	Finish, Description, etc.	Lamp Ordering Abbreviation (Except Volts)	Std. Pkg. Qty.	Rated Initial Lumens	Max. Over-all Length (Ins.)	Average Light Centre Length (Ins.)	Position of Burning
25	220	A-19	Med.	I. F.....	25A	120	215	3 1/8	2 1/2	Any
50	220 285	A-21	Med.	I. F..... I. F. Mine.....	50A21 50A21	120	470 465	4 1/8	2 7/8	Any
100	220	A-23	Med.	I. F.....	100A	120	1100	6 1/8	4 3/8	Any
200	220	PS-30	Med.	Clear..... I. F.....	200 200/IF	60	2740	8 1/8	6	Any
300	220	PS-35	Mog.	Clear..... I. F.....	300 300/IF	24	4740	9 3/8	7	Any
500	220	PS-40	Mog.	Clear..... I. F.....	500 500/IF	24	8400	9 3/4	7	Any
750	220	PS-52	Mog.	Clear.....	750	6	13,750	13 1/8	9 1/2	Any
1000	220	PS-52	Mog.	Clear.....	1000	6	18,800	13 1/8	9 1/2	Any



INCANDESCENT LAMPS

General Electric Lamps For Low Voltage General Lighting Service

Watts	Volts	Bulb	Base	Finish, Description, etc.	Lamp Ordering Abbreviation (Except Volts)	Std. Pkg. Qty.	Rated Initial Lumens	Max. Over-all Length (Ins.)	Average Light Centre Length (Ins.)	Position of Burning
15	6 and 12	A-17	Med.	L. F.	15A	120	190	3 3/4	2 3/4	Any
25	6 and 12	A-19	Med.	L. F.	25A	120	350	3 1/2	2 1/2	Any
50	6 and 12	A-21	Med.	L. F.	50A21	120	800	4 1/2	3 3/4	Any

General Electric Lamps For Street Railway Service

Watts	Volts	Bulb	Base	Finish, Description, etc.	Amps.	Lamp Ordering Abbreviation	Std. Pkg. Qty.	Rated Initial Lumens	Max. Over-all Length (Ins.)	Average Light Centre Length (Ins.)	Position of Burning
36	110, 115, 120	A-21 A-19	Med.	L. F. Clear Head	0.342	36A/RV 36A/RVH	120	365 375	4 1/4 3 1/2	2 3/4 2 1/4	Any
50	110, 115, 120	A-21 P-25	Med.	L. F. Clear Head	0.519	50A21 50P25	120 60	620 555	4 1/4 4 3/4	2 3/4 2 1/4	Any
94	110, 115, 120	P-25	Med.	Clear Head	0.863	94P25	60	885	4 3/4	2 1/4	Any
101	110, 115, 120	A-23	Med.	L. F.		101A23	120	1150	6 1/4	4 3/4	Any
201	110, 115, 120	PS-30	Med.	Clear		201PS30	60	3100	8 1/4	6	Any
Amps 1.0	30	A-19	Med.	L. F.	1.0	1A/A19	120	395	3 1/2	2 1/2	Any
1.6	30	A-21	Med.	L. F.	1.6	1.6A/A21	120	705	4 1/4	2 3/4	Any

General Electric Lamps For Train, Locomotive and Country Home Service

15	30 and 60 34	A-17 S-14	Med.	L. F. L. F.		15A 15S14/IF	120	3 3/4 3 1/2	2 3/4 2 1/4	Any
25	30 and 60	A-19	Med.	L. F.		25A	120	3 1/2	2 1/2	Any
50	30 and 60	A-21	Med.	L. F.		50A21	120	4 1/2	3 3/4	Any
100	30 and 60 32	A-23 A-21	Med. Med.	L. F. Clear Loco Head		100A 100A21/3	120 60	6 1/4 4 1/4	4 3/4 3	Any B.D. to H.
250	32	P-25	Med.	Clear Loco Head		250P25	60	4 3/4	3	B.D. to H.

General Electric Lamps For Aviation Service

100	12	A-19	Med. Pref.	Clear Headlight		100A19	24	2200	4 3/4	1 3/4	B.D. to H.
240	12	A-19†	Med. Pref.	Clear Headlight		240A19	24	5750	4 3/4	1 3/4	B.D. to H.
420	12	G-25†	Mog. Pref.	Clear Headlight		420G25P	24	10,500	5 1/4	1 1/2	B.D. to H.
500	110, 115, 120	T-20	Mog. Pref.	Clear Airway Beacon		500T20P/AB	6	9000	9 1/2	3 1/4	B.D.
1000	30 110, 115, 120	T-20†	Mog. Bip.	Clear Airway Beacon		1M/T20BP 1M/T20BP	6 6	25,500 20,500	9 1/2	4	B.D.
1500	32	T-24†	Mog. Bip.	Clear Airport Floodlight		1500T24	6	42,000	10 1/2	4	B.D.
3000	32	T-32†	Mog. Bip.	Clear Airport Floodlight		3M/T32	4	88,500	14	5 3/4	B.D.
5000	110, 115, 120	T-64†	Mog. Bip.	Clear Airport Floodlight		5M/T64/1	2	164,000	13 3/4	6 1/2	B.D.
10000	110, 115, 120	G-96†	Mog. Bip.	Clear Airport Floodlight		10M/G96/2	1	325,000	17 3/4	10	B.D.

†Heat-resisting glass bulb.



INCANDESCENT LAMPS

General Electric Lamps for Street Series Service—Clear Bulb

Rated Initial Lumens	Amperes	Bulb	Base	Description	Lamp Ordering Abbreviation	Std. Pkg. Qty.	Aver. Volts	Max. Over-all Length (Ins.)	Aver. Light Centre Length (Ins.)	Position of Burning
600	6.6	PS-25	Mog.	600/66	60	6.7	7 1/8	5 3/8	Any
800	6.6	PS-25	Mog.	800/66	60	8.2	7 1/8	5 3/8	Any
1000	6.6	PS-25	Mog.	1M/66	60	9.8	7 1/8	5 3/8	Any
1500	6.6	PS-25	Mog.	1500/66	60	13.9	7 1/8	5 3/8	Any
2500	6.6	PS-25 PS-35	Mog.	2500/66PS25 2500/66	60 24	22.0	7 1/8 9 3/8	5 3/8 7	Any Any
4000	6.6 15	PS-35	Mog.	Short—Base Up.....	4M/66	24	33.5 14.9	9 3/8	7	Any B.U.
				" — " Down.....	4M/15BU 4M/15BD					
	20	PS-40	Mog.	Long — " Up.....	4M/15PS40BU	12	10.6	9 3/8	7	B.U.
				" — " Down.....	4M/15PS40BD					
	PS-35	Mog.	Short — " Up.....	4M/20BU	24	10.6	9 3/8	7	B.U.	
			" — " Down.....	4M/20BD						
PS-40	Mog.	Long — " Up.....	4M/20PS40BU	12	10.6	12 5/8	9 1/2	B.U.		
		" — " Down.....	4M/20PS40BD							
6000	6.6 20	PS-40	Mog.	Short—Base Up.....	6M/66	24	50.2 15.8	9 3/4	7	Any B.U.
				" — " Down.....	6M/20BU 6M/20BD					
	20	PS-40	Mog.	Long — " Up.....	6M/20BU/1	12	15.8	12 5/8	9 1/2	B.U.
				" — " Down.....	6M/20BD/1					
10000	20	PS-40	Mog.	Short—Base Up.....	10M/20BU	24	26.3	9 3/4	7	B.U.
				" — " Down.....	10M/20BD					
	20	PS-40	Mog.	Long — " Up.....	10M/20BU/1	12	26.3	12 5/8	9 1/2	B.U.
				" — " Down.....	10M/20BD/1					
15000	20	PS-40	Mog.	Short—Base Up.....	15M/20BU	24	38.5	9 3/4	7	B.U.
				" — " Down.....	15M/20BD					
	20	PS-40	Mog.	Long — " Up.....	15M/20BU/1	12	38.5	12 5/8	9 1/2	B.U.
				" — " Down.....	15M/20BD/1					
25000	20	PS-52	Mog.	Long—Base Up.....	25M/20BU	6	62.2	13 1/8	9 1/2	B.U.
				" — " Down.....	25M/20BD					

General Electric Lamps For Spotlight and Floodlight Service

Watts	Volts	Bulb	Base	Finish, Description, etc.	Lamp Ordering Abbreviation (Except Volts)	Std. Pkg. Qty.	Rated Initial Lumens	Max. Over-all Length (Ins.)	Average Light Centre Length (Ins.)	Position of Burning
100	110, 115, 120	A-21	Med. Med. Pref.	Spot.....	100A21/SP 100A21/PSP	60	1400	4 7/16 4 11/16	3 2 3/16	Any position from vertically base down to horizontal
250	110, 115, 120	G-30	Med. Med. Pref.	Spot..... Flood..... Spot.....	250G/SP 250G/FL 250G/PSP	60	4400 3750 4400	5 1/8 5 3/8	3 2 3/16	
400	110, 115, 120	G-30	Med. Med. Pref.	Spot.....	400G/SP 400G/PSP	60	7850	5 1/8 5 3/8	3 2 3/16	
500	110, 115, 120	G-40	Mog.	Flood.....	500G/FL	12	8800	7 1/8	4 1/4	
1000	110, 115, 120	G-40#	Mog. # # # Mog. Pref.	Spot—4 1/4" L.C.L..... Flood—5 1/4" L.C.L..... Spot—5 1/4" L.C.L..... Spot—3 1/8" L.C.L.....	1M/G40SP4 1/4 1M/G40FL 1M/G40SP5 1/4 1M/G40PSP	12	22,500 19,000 22,500	7 1/8 8 8 8 1/8	4 1/4 5 1/4 5 1/4 3 1/8	

#Heat-resisting glass bulb.

General Electric Infrared Lamps—115-125 Volts*

Watts	Bulb	Base (†)	Finish, Description, etc.	Lamp Ordering Abbreviation (Except Volts)	Std. Pkg. Qty.	Max. Overall Length (Ins.)	Position of Burning
250	G-30 R-40	Med. Skt. Med. Skt. Med.	Infrared—Industrial (5" L.C.L.)..... Light I.F. Reflector Infrared—Industrial..... " — " —Heat..... Red Bowl Reflector Infrared—Heat †.....	250G30 250R40/4 250R40/1 250R40/10	60 24	7 1/8 7 1/4 6 1/2 6 3/4	Any
375 375	G-30 R-40	Med. Skt.	Clear Infrared—Industrial (5" L.C.L.)..... Light I. F. Reflector Infrared—Industrial.....	375G30 375R40	60 24	7 1/8 7 1/4	Any

†When closely banked, only sockets standing high temp. should be used and reasonable ventilation should be provided.
*Average laboratory life in excess of 5,000 hours. †Heat-resisting glass bulb.

LAMPS



GENERAL ELECTRIC FLUORESCENT LAMPS

What Colour Lamps?

To Obtain	Use
Best match with filament lighting.....	DeLuxe Warm White
Smooth blend with natural daylight.....	Standard Cool White
All colours at their best.....	DeLuxe Warm White
Most light per dollar (high efficiency).....	Standard Warm White
Warm mellow effect with highest efficiency.....	Standard Warm White
Cool neutral effect with highest efficiency.....	Standard Cool White
Excellent rendition of colours—cool atmosphere.....	DeLuxe Cool White
Excellent rendition of colours—warm atmosphere.....	DeLuxe Warm White
Accent of warm colours, reds, yellow, orange.....	DeLuxe Warm White
Accent of cool colours, blues, greens, greys and at the same time reds.....	DeLuxe Cool White

General Line Fluorescent Lamps* (For use with starters)

Nom. Lamp Watts	Bulb	M.O.L. (Ins.)	Base	Description	Lamp Ordering Abbreviation	Std. Pkg. Qty.	Lumens Output
6	T-5	9	Min. Bipin	Standard Cool White.....	F6T5/CW	25	200
8	T-5	12	Min. Bipin	Standard Cool White.....	F8T5/CW	25	310
13	T-5	21	Min. Bipin	Standard Cool White.....	F13T5/CW	25	600
14	T-12	15	Med. Bipin	Standard Cool White.....	F14T12/CW	25	500
14	T-12	15	Med. Bipin	Standard Warm White.....	F14T12/WW	25	525
15	T-8	18	Med. Bipin	Standard Cool White.....	F15T8/CW	25	660
15	T-8	18	Med. Bipin	DeLuxe Cool White.....	F15T8/CWX	25	390
15	T-8	18	Med. Bipin	Standard Warm White.....	F15T8/WW	25	690
15	T-8	18	Med. Bipin	DeLuxe Warm White.....	F15T8/WWX	25	415
15	T-12	18	Med. Bipin	Standard Cool White.....	F15T12/CW	25	570
15	T-12	18	Med. Bipin	DeLuxe Cool White.....	F15T12/CWX	25	340
15	T-12	18	Med. Bipin	Standard Warm White.....	F15T12/WW	25	610
15	T-12	18	Med. Bipin	DeLuxe Warm White.....	F15T12/WWX	25	360
20	T-12	24	Med. Bipin	Standard Cool White.....	F20T12/CW	25	900
20	T-12	24	Med. Bipin	DeLuxe Cool White.....	F20T12/CWX	25	540
20	T-12	24	Med. Bipin	Standard Warm White.....	F20T12/WW	25	930
20	T-12	24	Med. Bipin	DeLuxe Warm White.....	F20T12/WWX	25	560
30	T-8	36	Med. Bipin	Standard Cool White.....	F30T8/CW	25	1600
30	T-8	36	Med. Bipin	DeLuxe Cool White.....	F30T8/CWX	25	960
30	T-8	36	Med. Bipin	Standard Warm White.....	F30T8/WW	25	1700
30	T-8	36	Med. Bipin	DeLuxe Warm White.....	F30T8/WWX	25	1000
40	T-12	48	Med. Bipin	Standard Cool White.....	F40T12/CW	25	2300
40	T-12	48	Med. Bipin	DeLuxe Cool White.....	F40T12/CWX	25	1400
40	T-12	48	Med. Bipin	Standard Warm White.....	F40T12/WW	25	2450
40	T-12	48	Med. Bipin	DeLuxe Warm White.....	F40T12/WWX	25	1470
85	T-17	60	Mog. Bipin	Standard Cool White.....	F85T17/CW	12	4400
85	T-17	60	Mog. Bipin	Standard Warm White.....	F85T17/WW	12	4600

Instant Start Fluorescent Lamps* (No starters used)

40	T-12	48	Med. Bipin	Standard Cool White.....	F40T12/CW/IS	25	2300
40	T-12	48	Med. Bipin	Standard Warm White.....	F40T12/WW/IS	25	2450

Circline Fluorescent Lamps* (For use with starters)

32	T-10	12" O.D.	4-Pin	Standard Cool White.....	FC12T10/CW	12	—
32	T-10	12" O.D.	4-Pin	Standard Warm White.....	FC12T10/WW	12	—

*Refer "Notes" on next page.



GENERAL ELECTRIC FLUORESCENT LAMPS

Slimline Fluorescent Lamps (Instant Start—No Starters Used)

Nom. Lamp Watts	Bulb	M.O.L. (Ins.)	Base	Description	Lamp Ordering Abbreviation	Std. Pkg. Qty.	Lumens Output (300MA)
18-33	T-6	42	Single Pin	Standard Cool White.....	F42T6 /CW	25	1620
18-33	T-6	42	Single Pin	DeLuxe Cool White.....	F42T6 /CWX	25	970
18-33	T-6	42	Single Pin	Standard Warm White.....	F42T6 /WW	25	1670
27-51	T-6	64	Single Pin	Standard Cool White.....	F64T6 /CW	25	2600
27-51	T-6	64	Single Pin	DeLuxe Cool White.....	F64T6 /CWX	25	1560
27-51	T-6	64	Single Pin	Standard Warm White.....	F64T6 /WW	25	2650
26-51	T-8	72	Single Pin	Standard Cool White.....	F72T8 /CW	25	2900
26-51	T-8	72	Single Pin	DeLuxe Cool White.....	F72T8 /CWX	25	1740
26-51	T-8	72	Single Pin	Standard Warm White.....	F72T8 /WW	25	3000
26-51	T-8	72	Single Pin	DeLuxe Warm White.....	F72T8 /WWX	25	1800
34-69	T-8	96	Single Pin	Standard Cool White.....	F96T8 /CW	25	4000
34-69	T-8	96	Single Pin	DeLuxe Cool White.....	F96T8 /CWX	25	2400
34-69	T-8	96	Single Pin	Standard Warm White.....	F96T8 /WW	25	4150
34-69	T-8	96	Single Pin	DeLuxe Warm White.....	F96T8 /WWX	25	2490
72	T-12	96	Single Pin	Standard Cool White.....	F96T12 /CW	12	4400
72	T-12	96	Single Pin	DeLuxe Cool White.....	F96T12 /CWX	12	2640
72	T-12	96	Single Pin	Standard Warm White.....	F96T12 /WW	12	4500
72	T-12	96	Single Pin	DeLuxe Warm White.....	F96T12 /WWX	12	2700

- NOTES**
- 1.—All "Standard Warm White" listings were formerly "Warm Tint".
—All "Standard Cool White" listings were formerly "4500 white".
 - 2.—"White", "Daylight" and "Soft White" Lamps are available for replacements.
 - 3.—Lamps are available also in blue, pink, green, gold and red.
 - 4.—Lamp Watts only are listed. For total, add auxiliary watts.
 - 5.—For minimum watts loss in auxiliaries—specify "Quality" components.
 - 6.—Overall length of lamps includes dimension of two standard sockets.
 - 7.—Lumens output at end of 100 hours operation. Minimum values shown subject to continuous improvement.
 - 8.—Standard Instant Start Lamps also suitable for operation under conditions of high humidity.

MERCURY LAMPS

The principle of Mercury Lamps is that of an electron flow through ionized Mercury vapor. The radiation output is represented by narrow wavelength bands. By variation in design of the lamp, regulating the vapor pressure, current, voltage, etc., the distribution of energy in the different wavelengths can be controlled. This is the reason for the different appearance of various mercury lamps. Each lamp takes a design best adapted to efficient performance for the particular service intended.

General Lighting Types

- 400-watt H1 lamps — General use in factory, flood and street lighting.
- 3000-watt A-H9 — High Wattage lamp for High-Bay Industrial Lighting.
- A-H4 and A-H5 — Lower Wattage lamps for various uses.

Designation	GENERAL LIGHTING LAMPS				
	H100-A4	H250-A5	H400-A1 H400-B1	H400-E1	H3000-A9
Lamp Watts (Rated).....	100	250	400	400	3000
Watts, with Single-lamp Transformer.....	123	290	452	452	3220
Watts, with Tulamp Transformer.....	286 /lamp	440 /lamp	440 /lamp
Lumens (Rated).....	3,300	11,000	15,000	20,000	120,000
Mean Lumens (Approx.) 5 hours per start.....	3,050	9,300	13,000	16,600	103,000
Overall lumens per watt (single-lamp trans).....	26.8	37.9	33.2	44.3	37.9
Rated Life, Hours (See Note).....	1000	3000	4000	3000	5000
Bulb.....	T-10	T-18	T-16	T-20	T-9
Finish.....	Clear	Clear	Clear	Clear	Clear
Base.....	Admed.	Mogul	Mogul	Mogul	S.C. Term.
Burning Position.....	Any	Any	See Note	Any	Any
Max. Over-all Length, Inches.....	5 $\frac{5}{8}$	8	13	11	55
Light Center Length, Inches.....	3 $\frac{7}{16}$	5	7 $\frac{3}{4}$	7
Pressure, Atmospheres.....	8	1.2	0.7
Number of Electrodes.....	3	3	3	3	2
Lamp Operating Volts.....	130	135	135	135	535
Lamp Starting Current, Amps.....	1.3	2.9	5	5	9.3
Lamp Operating Current, Amps.....	0.9	2.1	3.2	3.2	6.1
Supply Voltage (Primary Volts) †.....	115,230	118,236	115,230	118,236	230, 460, 575
Transformer Secondary Open Circuit Voltage.....	245	250	220	220	850
Power Factor, Per Cent.....	50, 90	50, 90, 95	60, 90, 95	60, 90, 95	90
Starting Time to Full Output—On Lag Circuits.....	3 min.	10 min.	14 min.	8 min.	7 min.
Restarting Time—On Lag Circuits.....	3 min.	4 min.	14 min.	5 min.	8 min.
Standard Package Quantity.....	6	6	6	6	1

†Nominal voltage—lamp design is centered for the range of standard voltage circuits.
 Rated Lives: Based on Test Conditions with lamps switched "Off" and restarted every 5 hours.
 Burning Position: H400-A1 is for Base-up burning; H400-B1 for Base-Down burning.
 Both types must be operated within 10° of vertical.
 Power Factor: Higher power factor is obtained with transformers incorporating integral correction. Tulamp Transformers have an over-all power factor of 95%.

LAMPS

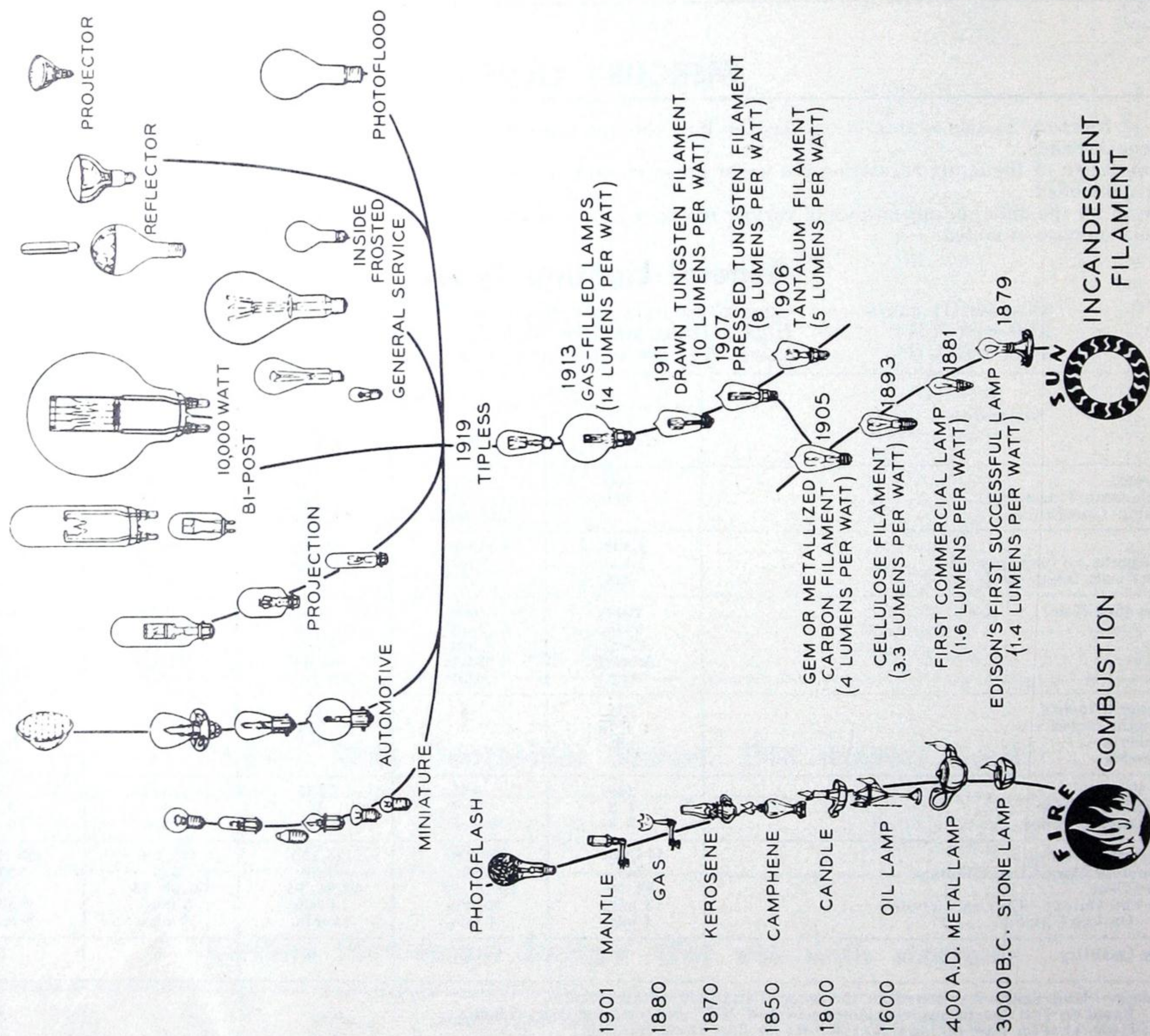
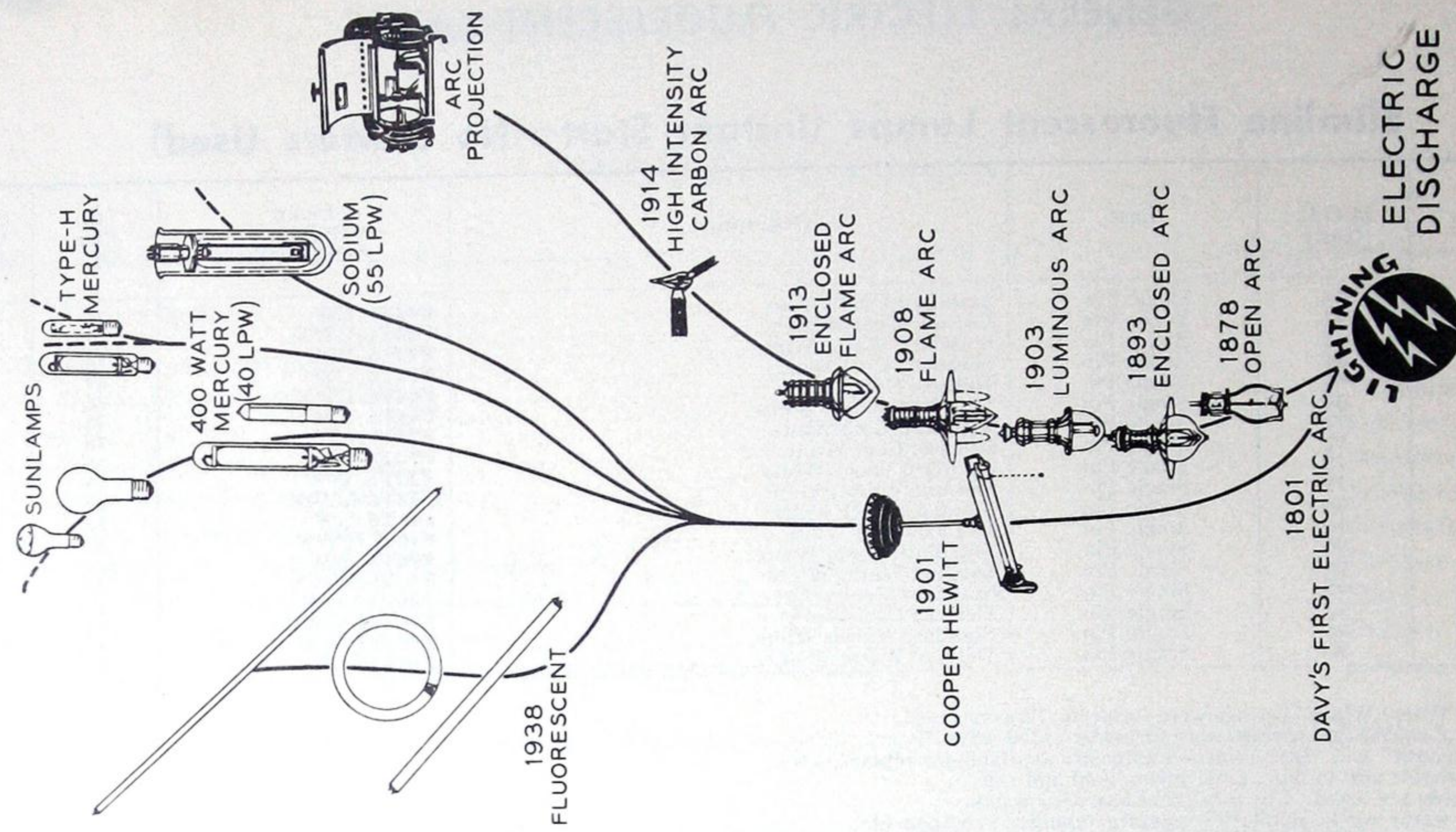

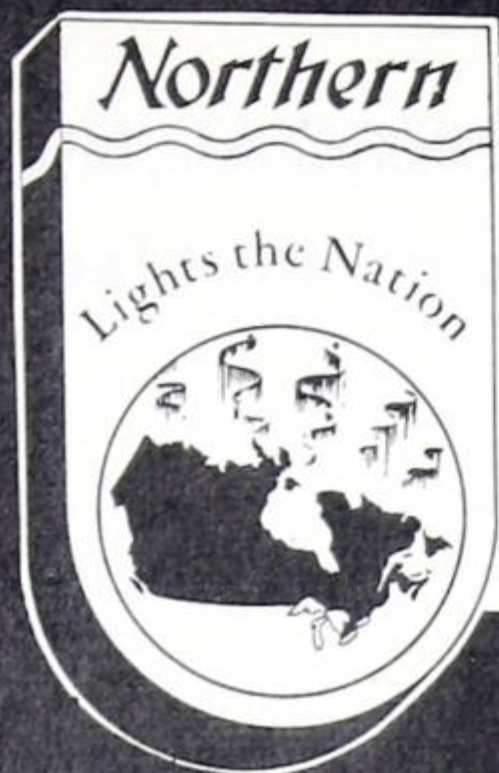
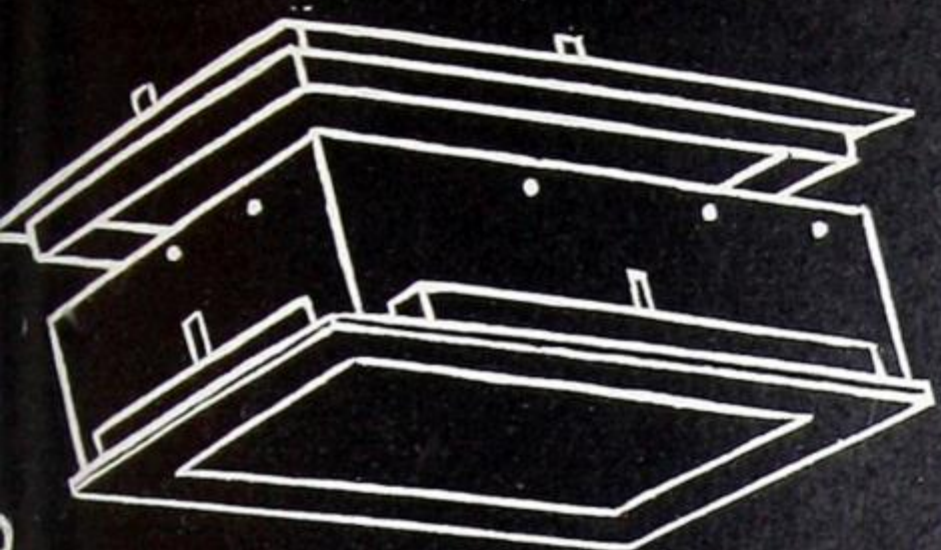

COMMERCIAL LIGHTING (INCANDESCENT)



CONTENTS

Recessed Units — Less Reflectors	86
Prismatic Glassware Units	76
Hospital Lighting Units	80
Louver Lights	84
Display Spotlights	89, 91
Downlights	90
Lighting Glassware — Glassware Only	93
Lighting Glassware — Complete Units	97
Suspension Hangers and Ceiling Bands	96
Church Lighting Units	98
Exit Lights	100
Gymnasium Units	100
Outdoor Units	101
Strip Lighting	103
Adjustable Portable Units	104

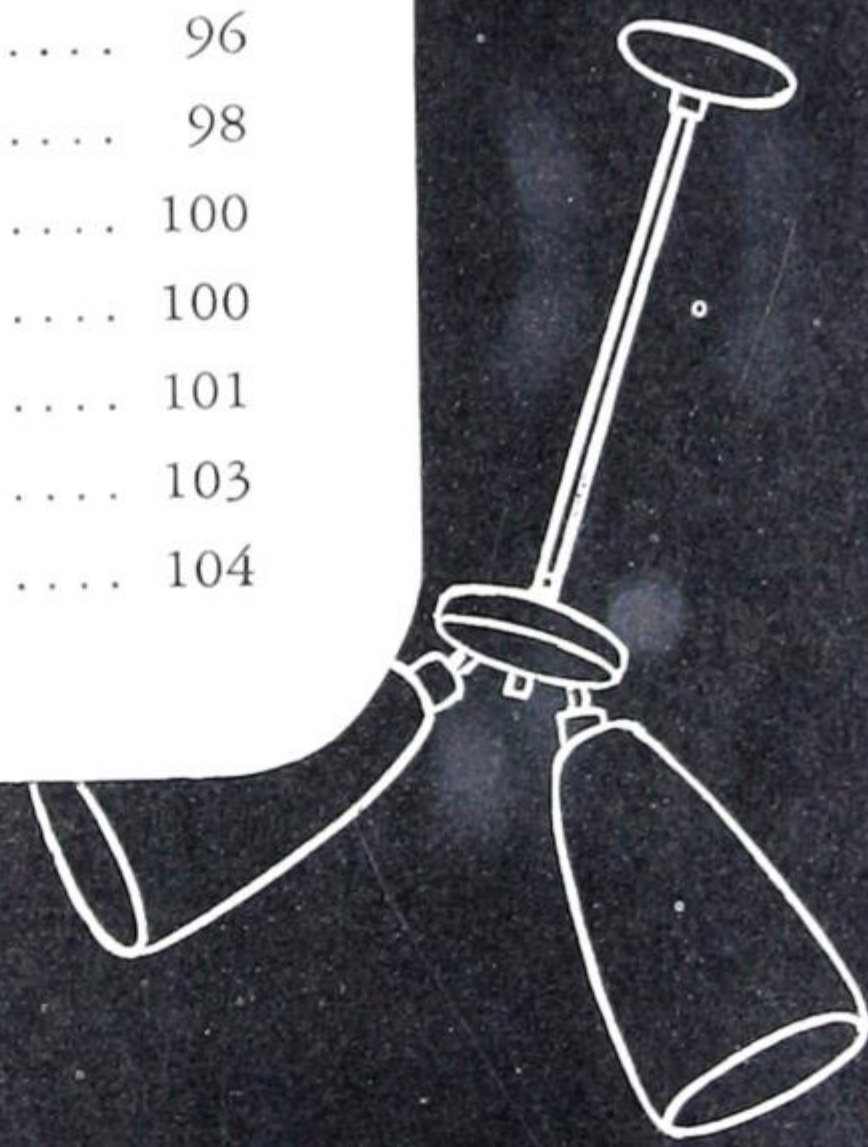

Use the

Northern Electric Lighting Service



DESIGN DATA FOR COMMERCIAL LIGHTING

Factors Affecting Design Problems

GENERAL CONSIDERATIONS

- 1. Room Function
- 2. Structural Features
- 3. Colour Harmony
- 4. Personnel
- 5. Housekeeping

1

FACTORS AFFECTING METHOD OF LIGHTING

- 1. Texture
- 2. Colour
- 3. Elevation
- 4. Operative Process
- 5. Colour Contrast
- 6. Shadows
- 7. Highlights
- 8. Silhouette

2

FACTORS AFFECTING AMOUNT OF LIGHT

- 1. Size
- 2. Contrast
- 3. Reflection Factors
- 4. Movement
- 5. Time

3

RECOMMENDED VALUE OF LIGHT

Determination of the required quantity of illumination for the specific visual task or tasks.

(TABLE I)

4

METHOD OF LIGHTING

- 1. General
- 2. Localized
- 3. Local
- 4. Special

5

FACTORS AFFECTING CHOICE OF FIXTURES AND LIGHT SOURCE

- 1. Distribution
- 2. Brightness
- 3. Mechanical Features
- 4. Efficiency
- 5. Spectral Characteristics

6

ROOM INDEX (TABLE IX)

- 1. Room Proportions
- 2. Floor Area
- 3. Mounting Height
- 4. Light Distribution

7

COEFFICIENT OF UTILISATION C.U.

- 1. Reflection Factors (Walls, Ceiling)
- 2. Room Index
- 3. Type of fixture

8

DESIGN FORMULAE

$$\text{Total Lumens} = \frac{\text{Footcandles} \times \text{Area}}{\text{Coefficient of Utilisation} \times \text{Maintenance Factor}}$$

$$\text{Number of Lamps} = \frac{\text{Footcandles} \times \text{Area}}{\text{Lumens per Lamp} \times \text{Coefficient of Utilisation} \times \text{Maintenance Factor}}$$

$$\text{Luminaires} = \frac{\text{Footcandles} \times \text{Area}}{\text{Lamps per Luminaire} \times \text{Lumens per Lamp} \times \text{Coefficient of Utilisation} \times \text{Maintenance Factor}}$$

$$\text{Footcandles} = \frac{\text{Lamp Lumens} \times \text{Coefficient of Utilisation} \times \text{Maintenance Factor}}{\text{Area}}$$

$$\text{Area per Luminaire} = \frac{\text{Lamps per Luminaire} \times \text{Lumens per Lamp} \times \text{Coefficient of Utilisation} \times \text{Maintenance Factor}}{\text{Footcandles}}$$

9



DESIGN DATA FOR COMMERCIAL LIGHTING

Interior lighting design includes many problems peculiar to specific applications such as lighting for hospitals, churches, public buildings, libraries, stores, offices, schools, etc. It is not possible in a publication of this nature to cover adequately all the aspects of each of these applications. The purpose of this section is to cover in general terms the more common problems of office, school and store lighting.

The **Northern Electric Lighting Service** is available for information and advice with reference to any of the lighting applications mentioned. For assistance in the planning of any interior lighting layout or the preparation of specific recommendations **CONSULT YOUR LOCAL NORTHERN ELECTRIC OFFICE.**

QUANTITY AND QUALITY—The amount of light and degree of comfort with which persons can see easily and quickly the aesthetic, decorative or attraction value of the lighting as applied to different interior lighting techniques are complimentary factors and are of prime importance. A method of evaluating the quality of a lighting installation is discussed in that part of the basic design data section of this catalogue entitled "Glare Factors".

Quantity—Many factors are involved when determining the required amount of illumination for specific applications. For specific visual tasks the size of the object, brightness, degree of contrast and time required to perform the task should be taken into consideration. Lighting for display, effect or architectural design involves consideration of the creative desires, aesthetic effect, highlights, shadows and other factors, which, depending on the application, may be of more importance than those factors governing prolonged visual tasks.

Levels of illumination for interior lighting recommended by the Illuminating Engineering Society for many of the common seeing tasks are given in table I. These recommendations are generally minimum values for good current practice and reflect a consideration of many variables such as economic factors, convenience and availability.

Quality—Ease of vision depends upon the achievement of suitable brightnesses of the work itself and between the work and surroundings. The relationship between brightness and illumination should be clearly understood. The brightness of the sun on a summer day when viewed directly or reflected in a body of water or mirror creates a blinding effect detrimental to seeing. When the eyes are shielded from the sun or protected from the reflected glare seeing conditions are comfortable. The illumination provided by the sun is adequate but the brightness of the source itself or reflected glare is detrimental to the process of seeing.

Similar conditions may occur in any interior lighting installation if it is not correctly designed. These factors of brightness, brightness ratios and the direction of the light flux directly effect the *quality* of any lighting installation.

Luminaires and Light Sources—Luminaires and light sources available for commercial lighting applications are too numerous to describe in detail in this design data section. The illustrations shown represent typical luminaires taken from the catalogue section. Table II indicates the important factors to consider in the selection of a luminaire.

Table I. Levels of Illumination — Good Current Practice*

Area	Footcandles Maintained In Service	Area	Footcandles Maintained In Service
ART GALLERIES:		HOMES—Cont'd.	
General.....	10	Specific visual tasks	
On paintings (supplementary illumination).....	50	Reading—	
BANKS		Prolonged periods (smaller type).....	40
Lobby.....	20	Casual periods (larger type).....	20
Cages and offices.....	50	Study.....	40
BARBER SHOPS AND BEAUTY PARLORS.....	50	Reading piano scores—	
CHURCHES		Advanced (scores with grace notes and fingering notations for complex chords. When score is sub-standard size, and notations are printed on the lines, 100 foot-candles or more are needed).....	40 or more
Auditoriums.....	10	Intermediate (average scores having notations beside musical notes).....	20
Sunday School rooms.....	20	Elementary (simple scores for beginners).....	10
Pulpit or rostrum (supplementary illumination)....	20	Writing.....	20
Art glass windows—		Sewing—	
Light colour.....	20	Dark fabrics (fine detail, low contrast).....	150 or more
Medium colour.....	100**	Prolonged periods (light to medium fabrics)....	80
Dark colour.....	200**	Occasional (light fabrics).....	40
CLUB AND LODGE ROOMS		Occasional (coarse thread, large stitches, high contrast thread to fabric).....	20
Lounge and reading rooms.....	20	Kitchen duties—	
Auditoriums.....	10	Sink, range food preparation center.....	40
COURT ROOMS.....	20	Laundry—	
DANCE HALLS.....	5	Tubs, ironing board, ironer.....	40
DEPOTS, TERMINALS, AND STATIONS		Make-Up—	
Waiting room.....	20	Dressing tables and dressers.....	20
Ticket offices—		Shaving—	
General.....	20	Bathroom mirror.....	40
Ticket rack and counters, (supplementary illumination).....	50	Handcraft—	
Rest rooms and smoking room.....	20	Work bench.....	40
DRAFTING ROOMS		Game table—	
Prolonged close work, art drafting, and designing in detail.....	50	Card table.....	10
FARMS		Ping pong, recreational.....	20
Milk house.....	10	HOSPITALS	
HOMES		Emergency Room—	
General lighting—		General.....	50
Entrance hall, stairway, stair landing, dining room, bedroom, bathroom.....	5	Local.....	200
Kitchen.....	10	Examining room.....	50



DESIGN DATA FOR COMMERCIAL LIGHTING

Area	Footcandles Maintained In Service	Area	Footcandles Maintained In Service	
HOSPITALS—Cont'd.		POST OFFICE		
Laboratories—		Lobby.....	20	
Close work.....	100	Sorting, mailing, etc.....	50	
General, room.....	30	Storage.....	10	
Work tables.....	50	File room.....	30	
Morgue and autopsy—		Stairways.....	10	
Autopsy room.....	30	Corridors.....	5	
Autopsy table.....	200	PROFESSIONAL OFFICES		
Morgue, general.....	20	Waiting rooms.....	20	
Nurses station—		Consultation rooms.....	30	
General.....	20	Examination rooms (supplementary illumination).....	100	
Desks and charts.....	30	Dental chairs (supplementary illumination).....	200	
Nurseries—		RESIDENCES (see HOMES)		
General.....	20	RESTAURANTS, LUNCH ROOMS		
Examination and treatment.....	50	CAFETERIAS		
Obstetrical—		Dining area.....	10	
Delivery room.....	50	Food displays.....	50	
Delivery table.....	200	Kitchens.....	20	
Pharmacy—		SCHOOLS		
General.....	30	Classrooms (on desks and chalkboards).....	30 (1)	
Work table.....	50	Study halls, lecture rooms, art rooms, offices, libraries, shops and laboratories.....	30	
Private rooms and wards—		Classrooms for partially seeing pupils and those requiring lip reading (on desks and chalkboards).....	50	
General.....	5	Drafting rooms, typing rooms and sewing rooms.....	50	
Reading.....	20	Reception rooms, gymnasiums and swimming rooms.....	20	
Scrub-up rooms.....	20	Auditoriums (not for study), cafeterias, locker rooms, washrooms, corridors containing lockers, stairways.....	10	
Solaria.....	30	Open corridors and store rooms.....	5	
Sterilizing, central.....	30	SERVICE SPACE		
Surgery—		Stairways.....	10	
General.....	50	Elevators, freight and passenger.....	10	
Operating table.....	1,800	Corridors.....	5	
Therapy—		Storage (see STORAGE AND STOCK ROOMS)		
Physical.....	15	Toilets and wash rooms.....	10	
Occupational.....	30	SHOW WINDOWS		
Treatment room—		High surrounding brightness areas—		
General.....	30	General displays.....	200 (2)	
Examining table.....	50	Feature displays.....	500 (3)	
X-Ray—		Medium surrounding brightness areas—		
Radiography and fluorescopy.....	10	General displays.....	100 (4)	
Dark room.....	10	Feature displays.....	200 (2)	
Waiting room.....	10	Low surrounding brightness areas—		
Office and viewing.....	30	General displays.....	50 (5)	
HOTELS		Feature displays.....	100 (4)	
Lobby.....	20	STAIRWAYS.....		10
Dining room.....	10	STORE INTERIORS		
Kitchen.....	20	Circulation areas.....	20	
Guest rooms (supplementary illumination).....	30	General merchandising areas.....	50 (5)	
Corridors.....	10	Show cases, wall cases, and open counter displays.....	100**	
Writing rooms (supplementary illumination).....	30	Feature displays.....	200**	
LIBRARY		Stock rooms.....	10	
Reading room—		THEATRES AND MOTION PICTURE HOUSES		
Difficult seeing tasks.....	50	Auditoriums—		
Ordinary seeing tasks.....	30	During intermission.....	5	
Stacks—		During picture.....	0.1	
Open to the public.....	30	Foyer.....	5	
Closed to the public.....	10	Lobby.....	20	
Book repair and binding.....	30	TOILETS AND WASH ROOMS.....		10
Cataloging.....	30	*Illuminating Engineering Society—Lighting Handbook 2nd Edition.		
Card files.....	30	**Supplementary luminaires often are used in conjunction with a general lighting level of not less than 20 footcandles to provide the level required on the work.		
Check-in and check-out desks.....	30	(1) Where schools use chalkboards extensively for demonstration purposes, higher levels than those indicated are desirable		
LOCKER ROOMS.....		(2) Range: 150 to 300 ft-c		
MUSEUMS		(3) Range: 300 to 700 ft-c		
General.....	10	(4) Range: 70 to 150 ft-c		
Special displays (supplementary illumination).....	50	(5) Range: 30 to 70 ft-c		
OFFICES				
Difficult seeing tasks: auditing and accounting, business machine operation, transcribing and tabulation, bookkeeping, drafting, designing.....	50			
Ordinary seeing tasks: general office work (except for work coming under "Difficult seeing tasks" above), private office work, general correspondence, conference rooms, active file rooms, mail rooms.....	30			
Casual seeing tasks: inactive file rooms, reception rooms, stairways, washrooms, and other service areas.....	10			
Simple seeing tasks: hallways and corridors, passageways.....	5			

DESIGN DATA FOR COMMERCIAL LIGHTING

"STORE-LITER"

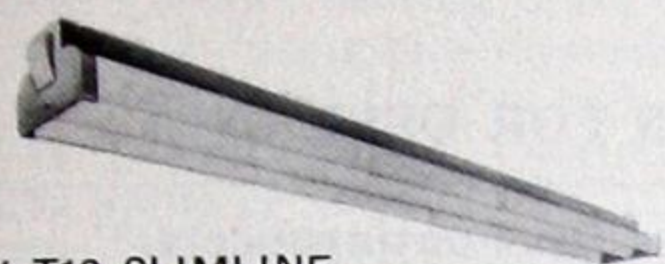

2x96" T12 SLIMLINE
PLASTIC SIDE PANELS

SPACING .75xMH EFF 86.0%

M.F.
G.75 19.0% ↑
M.65 67.0% ↓
P.55

CEILING	75%			50%		
WALLS	50%	30%	10%	50%	30%	10%
ROOM INDEX	COEFFICIENT OF UTILISATION					
J	.33	.27	.24	.31	.27	.23
I	.40	.35	.32	.38	.34	.31
H	.44	.40	.37	.42	.39	.36
G	.49	.45	.41	.46	.42	.39
F	.53	.48	.44	.49	.45	.42
E	.57	.53	.49	.54	.50	.47
D	.62	.57	.53	.57	.54	.51
C	.64	.60	.55	.60	.56	.53
B	.68	.64	.60	.63	.59	.57
A	.70	.66	.63	.65	.61	.59

"LENOX-2" SUSPENSION

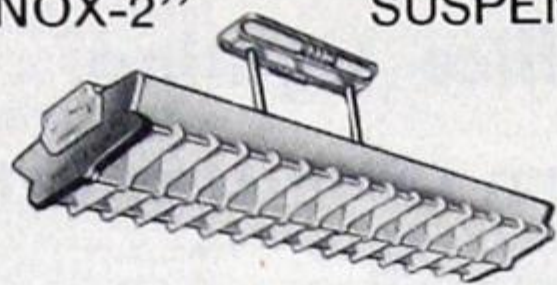

2x40W PLASTIC SIDE PANELS

SPACING 1.25xMH EFF 83%

M.F.
G.70 37.5% ↑
M.65 45.5% ↓
P.60

CEILING	75%			50%		
WALLS	50%	30%	10%	50%	30%	10%
ROOM INDEX	COEFFICIENT OF UTILISATION					
J	.29	.26	.24	.27	.24	.23
I	.36	.32	.31	.32	.30	.28
H	.39	.36	.34	.35	.33	.31
G	.43	.40	.37	.39	.36	.34
F	.46	.42	.39	.41	.38	.36
E	.49	.46	.44	.43	.41	.39
D	.53	.49	.47	.46	.44	.42
C	.55	.52	.49	.48	.46	.44
B	.58	.55	.53	.50	.48	.46
A	.59	.57	.54	.52	.50	.48

"TROFFER" RECESSED



2x96" T-12 SLIMLINE LOUVER

SPACING 1.2xMH EFF 57.0%

M.F.
G.75 0% ↑
M.70 57.0% ↓
P.65

CEILING	75%			50%		
WALLS	50%	30%	10%	50%	30%	10%
ROOM INDEX	COEFFICIENT OF UTILISATION					
J	.29	.27	.25	.28	.26	.24
I	.35	.33	.31	.34	.32	.30
H	.37	.36	.35	.37	.35	.34
G	.41	.39	.38	.40	.38	.37
F	.43	.41	.39	.41	.39	.38
E	.45	.44	.42	.44	.43	.41
D	.49	.46	.44	.48	.45	.43
C	.51	.47	.46	.49	.46	.45
B	.52	.48	.48	.50	.47	.46
A	.53	.50	.49	.51	.48	.47

TABLE II FACTORS AFFECTING LUMINAIRE SELECTION

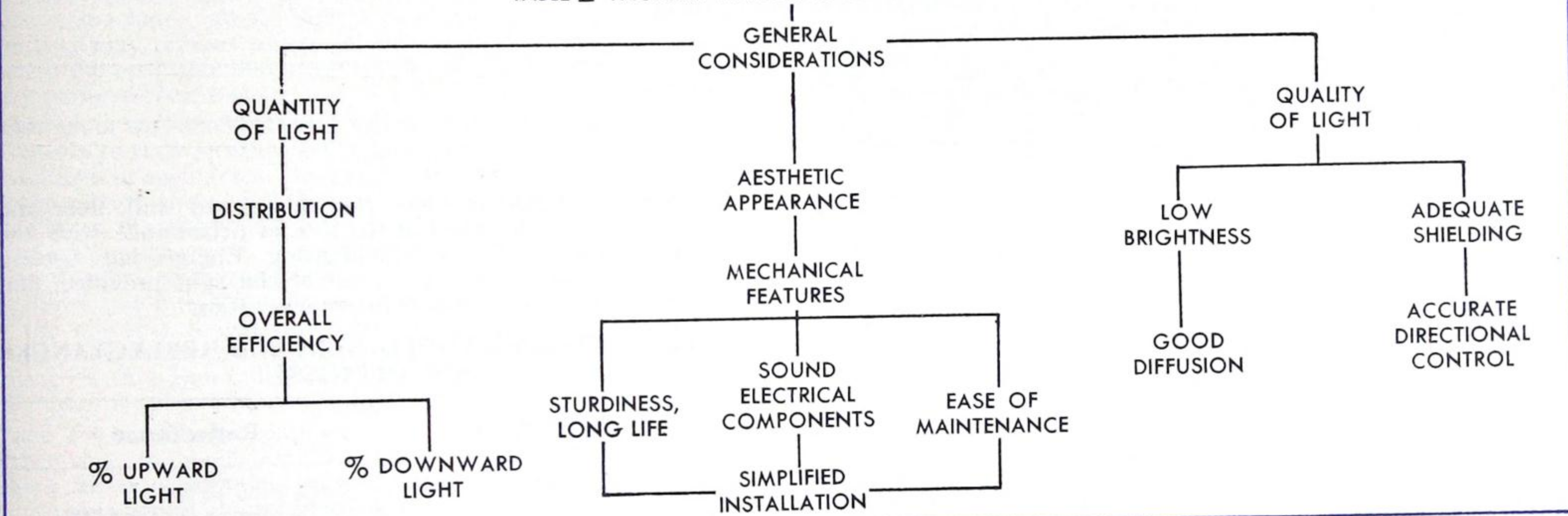

"CORRECTALITE" SEMI-RECESSED



200-300W PRISMATIC GLASSWARE

SPACING 1.25xMH EFF 60.4%

M.F.
G.90 2.5% ↑
M.85 57.9% ↓
P.70

CEILING	75%			50%		
WALLS	50%	30%	10%	50%	30%	10%
ROOM INDEX	COEFFICIENT OF UTILISATION					
J	.31	.29	.27	.30	.28	.27
I	.37	.35	.34	.37	.35	.34
H	.40	.39	.38	.39	.38	.37
G	.43	.42	.41	.42	.41	.40
F	.46	.44	.42	.44	.43	.41
E	.48	.46	.46	.47	.45	.44
D	.51	.48	.47	.49	.47	.46
C	.52	.50	.48	.51	.49	.47
B	.55	.51	.50	.52	.50	.49
A	.54	.53	.51	.53	.51	.50

"CHALLENGER" 210 SUSPENSION



300W-1000W SILVER BOWL

SPACING 1.2xCH EFF 92.0%

M.F.
G.70 88.5% ↑
M.65 3.5% ↓
P.55

CEILING	75%			50%		
WALLS	50%	30%	10%	50%	30%	10%
ROOM INDEX	COEFFICIENT OF UTILISATION					
J	.17	.14	.12	.13	.11	.09
I	.21	.17	.16	.16	.14	.12
H	.24	.21	.18	.18	.15	.14
G	.27	.24	.21	.21	.18	.16
F	.30	.27	.23	.23	.20	.18
E	.33	.30	.27	.25	.22	.20
D	.37	.33	.31	.27	.25	.23
C	.39	.36	.33	.29	.26	.25
B	.43	.40	.37	.31	.30	.28
A	.45	.42	.40	.34	.31	.30

OPEN TYPE INCANDESCENT RECESSED



300-500W LOUVER

SPACING .75xMH EFF 51.0%

M.F.
G.70 0% ↑
M.60 51.0% ↓
P.55

CEILING	75%			50%		
WALLS	50%	30%	10%	50%	30%	10%
ROOM INDEX	COEFFICIENT OF UTILISATION					
J	.32	.30	.29	.31	.30	.29
I	.38	.36	.36	.37	.35	.35
H	.40	.40	.39	.40	.38	.38
G	.43	.43	.42	.42	.41	.41
F	.45	.44	.43	.43	.43	.42
E	.47	.46	.46	.46	.46	.45
D	.50	.48	.47	.48	.47	.47
C	.51	.49	.48	.49	.48	.47
B	.51	.50	.49	.50	.49	.48
A	.52	.51	.50	.51	.50	.49



DESIGN DATA FOR COMMERCIAL LIGHTING

Office Lighting

TABLE III. MAXIMUM RECOMMENDED LUMINAIRE BRIGHTNESS VALUES FOR OFFICES†

Zone* (0 is directly below luminaire)	Maximum Recommended Brightness (In Footlamberts)**	
	Preferred	Acceptable With Suitable Environment
0-45°	1000	2300
45-60°	450	900
60-87°	225	450

*The line of demarcation between zones is not a sharp one. Tests indicate that maximum brightness in any zone above 45 degrees usually occurs at the lowest angle in the zone. In the 0 to 45 degree zone the maximum generally occurs between 0 and 30 degrees.

**Average initial brightness (by laboratory measurement) of the brightest one inch square viewed crosswise and endwise. Values given are based largely upon experience and are offered only as a guide until studies are completed to verify their accuracy. It is believed that the value given for any one of the three zones may be exceeded in a specific instance by 10 per cent without materially affecting visual comfort.

†Illuminating Engineering Society—Lighting Handbook. 2nd Edition.

TABLE IV. RECOMMENDED BRIGHTNESS RATIOS FOR OFFICES†

Brightness ratios of areas of appreciable size from normal viewpoints should not exceed:
3 to 1 Between tasks and adjacent surroundings.
10 to 1 Between tasks and more remote surfaces,
20 to 1 Between luminaires or windows and surfaces adjacent to them,
40 to 1 Anywhere within the normal field of view.
These ratios are recommended as maximums; reductions are generally beneficial.

†Illuminating Engineering Society—Lighting Handbook. 2nd Edition.

The nature of the work performed in most offices requires the eyes to be continually engaged in close detail work for prolonged periods of time. The illumination values recommended in Table I should be maintained as a minimum in service in the working area as these values indicate the currently accepted economic compromises with optimum amounts. Wherever possible, higher values than those listed should be used.

LUMINAIRE BRIGHTNESS—To avoid objectionable direct and reflected glare in average sized offices, the maximum luminaire brightnesses shown in Table III are offered as a guide for luminaire selection. For greater seeing comfort, the preferred values should be observed, although lower values approaching a uniform 225 footlambert brightness over the entire 0 to 87 degree zone are often desirable and justified. When a compromise is deemed necessary between preferred results and practical or economic considerations, the acceptable maximum brightnesses given are considered satisfactory if light colours and matte finishes are used on room and furniture surfaces, the task is not highly specular, and the bright areas of the luminaires are small. In large offices where the luminaires occupy a large portion of the field of view, the accumulation of glare from the large lighted ceiling area and the multiplicity of luminaires in the 75 to 87 degree zone can be considerable. In this case the preferred maximum brightness in the 75 to 87 degree zone should be substantially below 225 footlamberts, especially in the direction of the principal view of the room occupants. Similarly, the acceptable maximum for this zone should be considerably less than 40 footlamberts. On the other hand, much higher values would not be objectionable in small offices where brightness at the high angles would not be in the field of view or where luminaires are so located that all luminaire brightnesses are behind the worker and reflections are away from him.

Brightness values for luminaires are not shown in this catalogue but are available for most lighting units listed, through the *Northern Electric Lighting Service*.

Next in importance to the brightness of the luminaire itself is the brightness ratios of the surroundings. If the movement of the eyes from the visual task to the surroundings necessitates frequent adaptations to variations in brightness between the work, the desk top, office machines, the floor, walls and ceiling; the eyes become tired more quickly and the strain on the nervous system causes fatigue, headaches, etc. Recommended brightness ratios for offices are shown in Table IV.

The correct selection of office furnishings and wall, floor and ceiling finishes with reflection factors in accordance with the Recommendations of the Illuminating Engineering Society Table V will ensure maximum use of the light provided, and assist in achieving satisfactory brightness ratios.

TABLE V. RECOMMENDED SURFACE REFLECTANCES FOR OFFICES†

Surface	Reflectance
Ceiling Finishes*	80% plus 15%
Walls	50% plus or minus 15%
Furniture	35% plus or minus 25%
Office Machines and Equipment	35% plus or minus 25%
Floors	35% plus or minus 30%

*Recommended reflectance is for finish only. Overall average reflectance of acoustic materials may be somewhat lower.

†Illuminating Engineering Society—Lighting Handbook. 2nd Edition.

GENERAL OFFICES—In planning the lighting for general offices which are usually relatively large areas, a symmetrical layout is usually desirable to provide flexibility in the original layout of office equipment and any changes which may have to be made from time to time.

Careful attention must be given to the mounting height of the lighting units and when fluorescent luminaires are used, the orientation of the unit relative to the position of the workers must also be considered.

Recommended spacing with relationship to the mounting height should be adhered to wherever practical and the mounting height, when possible, should be such as to keep the luminaires out of the field of view. From the standpoint of appearance, rows of units on long hangers are undesirable.

Workers should face that part of the luminaire presenting the lowest brightness and minimum area. In most cases, luminous-sided fluorescent units provide the most comfortable condition when viewed from the end but opaque-sided and troffer units, depending upon type, may be satisfactory whichever direction they are mounted.



DESIGN DATA FOR COMMERCIAL LIGHTING

Where high intensities are required, the type of lighting used may have a direct bearing upon other services. With a totally indirect system, using incandescent lamps, appreciably more heat would be generated by the high wattage lamps required than would be produced by a fluorescent lighting system providing the same value of illumination; consequently, any air conditioning system would have to be designed accordingly.

The basic factors in the selection of any lighting luminaire are summarized in Table II.

PRIVATE OFFICES—Conditions in private offices, because of their smaller size, do not present the same problems as general offices.

The smaller number of units required reduces the possibilities of excessive brightness in the field of view and the fact that there is less latitude in the layout of equipment usually allows the location of units to be of a specific pattern to provide maximum illumination in the working area. In small square offices, where one person is working, an "L"-shaped layout is often suitable with the apex of the "L" approximately above the desk.

For larger square offices, occupied by two or three persons, a square layout may be used and in a small narrow office a "U"-shaped arrangement with base of the "U" approximately over the working area.

Executive offices and reception rooms lend themselves to special treatment using cove lighting, luminous ceilings and variations in layout design using conventional lighting equipment.

SPECIAL CONSIDERATIONS—Office machines, filing areas and mail rooms require special attention. In these locations the keys of machines, plastic indicators of files and glossy envelope windows may present sources of reflected glare, causing discomfort to the operators and affecting the efficiency with which they may perform their tasks.

Selection of well-shielded low brightness luminaires and particular attention to their location will help in providing the best working conditions in such areas. In filing areas, illumination is required on the vertical surfaces of the files. There should be a minimum of shadow in the open file folders and the worker should not cast shadows over the work. Luminaires should be directly above the open drawers wherever possible. The operation of some office machines involves a number of critical seeing tasks. The parts of the machine should not have any highly polished surfaces likely to cause distracting glare, but if the body of the machine is finished with a high-reflectance matte finish contrast is considerably improved and more comfortable seeing conditions result.

When the operator is required to operate a machine by sight rather than by touch and when detailed checking is required, higher levels of illumination than that provided by a general lighting system is sometimes necessary. In such cases, supplementary lighting is desirable.



GLASS DESK TOPS, GLASS COVERED PICTURES AND GLOSSY FURNITURE ARE POTENTIAL SOURCES OF REFLECTED GLARE. NOTE REFLECTION OF LIGHTING UNITS IN GLASS DESK TOP IN ABOVE ILLUSTRATION.

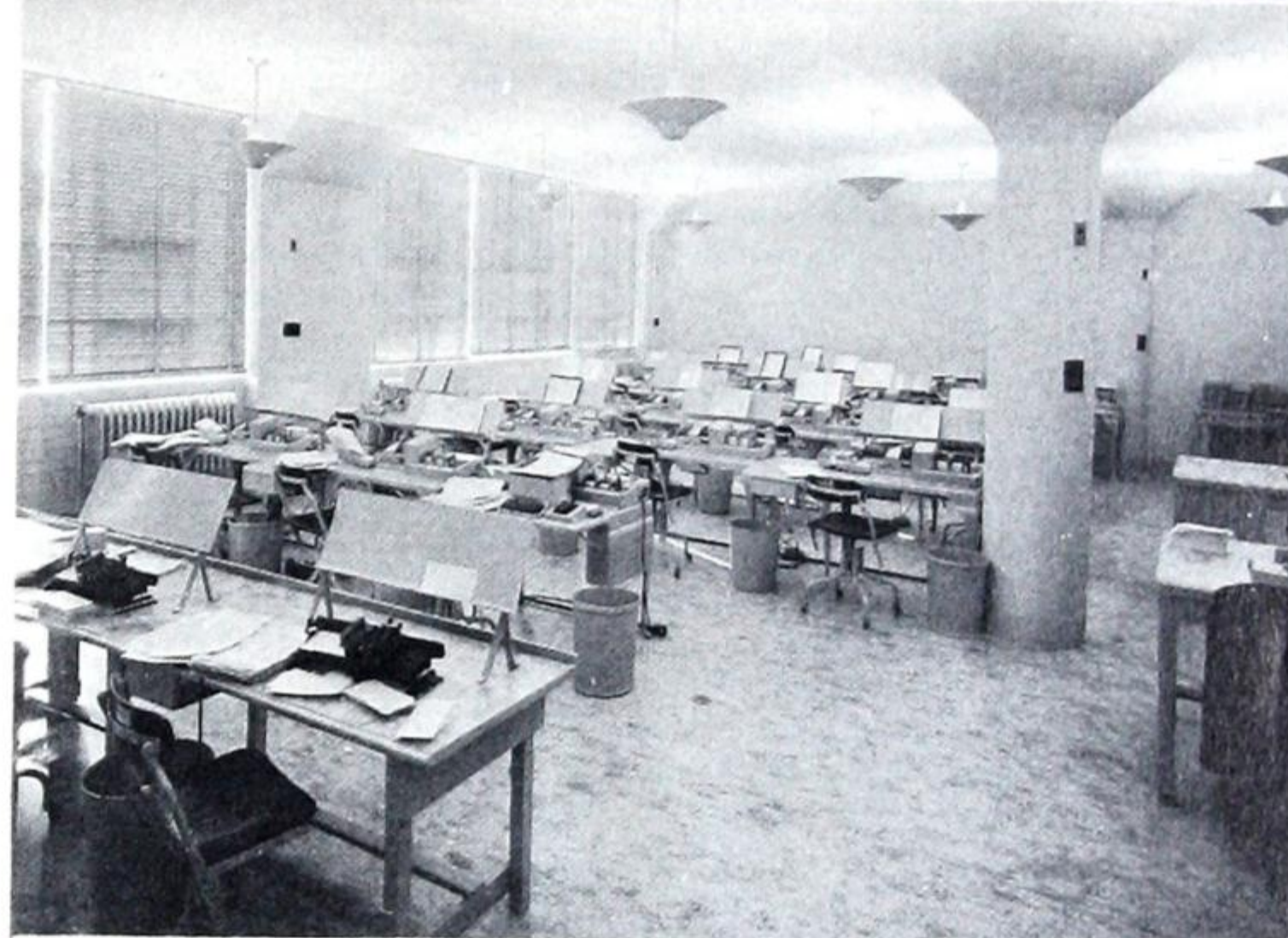

RESULTS OF TESTS IN CARD PUNCH OPERATING ROOM U.S. CENSUS BUREAU*.
TOP.—NO IMPROVEMENT MADE. CENTER.—AFTER REPAINTING.
BOTTOM.—AFTER REPAINTING AND RELIGHTING.

Photograph	Brightness Ratio	Average Footcandles	Lighting Efficiency
Top	100 - 1	11	9%
Center	21 - 1	30	25%
Bottom	13 - 1	43	26%

*From a paper by L.M. Enders, Illuminating Engineering Society. National Technical Conference 1951.



DESIGN DATA FOR COMMERCIAL LIGHTING

School Lighting

Modern school lighting incorporates the applications of most phases of lighting design; industrial lighting, stage lighting, lighting for auditoriums, art-rooms, libraries, etc. This section will discuss briefly the lighting of classrooms; industrial and stage lighting is dealt with in other sections of the catalogue and additional information is readily available through the *Northern Electric Lighting Service*.

The information given previously with regard to office lighting applies in very general terms to some aspects of classroom lighting. However, classroom lighting is in some respects more important, as good lighting in the school will assist materially in the preservation of the eyesight of the pupils, it will minimize visual strain and fatigue and provide a happy and cheerful learning environment.

It is recommended that the brightness ratios in the classroom should not exceed the limiting values listed in Table VII. Table VI gives the maximum luminaire brightnesses to avoid objectionable direct or reflected glare when used in typical classrooms lighted to current recommended levels.

Approximately double these brightnesses may be taken as maximum values when the bright areas of the luminaire are small and where great care has been taken to use light colours and matte finishes in the classroom. Most surfaces involving pencil, ink or typed matter have a certain degree of specularly. Where the work is specular, brightnesses in the 0 to 45 degree zone should be considerably less than 1000 footlamberts. Brightnesses as low as 250 footlamberts are suggested where reflected glare conditions are to be minimized. For classrooms substantially larger than typical schoolrooms, where the luminaires occupy a large portion of the field of view, the accumulation of glare from the multiplicity of luminaires can be considerable. In this case the brightnesses in the 75 to 90 degree zone should be kept substantially below 225 footlamberts, especially in the direction of the principal view of the occupants of the room.

TABLE VI. MAXIMUM RECOMMENDED LUMINAIRE BRIGHTNESS VALUES FOR SCHOOLS†

Zone (Crosswise and lengthwise; 0 is directly beneath luminaire)	Maximum Recommended Brightness*
0-45°	1000
45-60°	450
60-90°	225

*Average brightness of the brightest one inch square.

†Illuminating Engineering Society—Lighting Handbook 2nd Edition.

CLASSROOM INTERIOR FINISHES—The above illustration shows the reflectance values recommended for the various surface areas of a classroom. Assuming a proper distribution of light to these surfaces, they assure the brightness ratios in Table VII and also permit more useful light to be reflected back into the room.

The recommended 80 to 85 per cent for ceiling implies a matte white or near white finish which may extend down the side walls a distance of 12 to 18 inches. The reflectance range for the side walls of 50 to 70 per cent permits the use of the cheerful light pastel colours. The upper limit of 70 per cent should not be used unless all precautions are taken to make the rest of the room as nearly ideal as possible from the brightness ratios standpoint. The window wall should have a higher reflectance (75 to 85 per cent) than the other walls because it receives no direct daylight and it is visually adjacent to the higher brightness outside the windows. Desks and table tops should be of light natural woods sealed with non-glossy finishes. The 15 to 20 per cent reflectance range recommendation for the chalkboards is for typical conditions of use with light chalk. In order to maintain good visibility when light chalk is used, under no conditions should the reflectance of the chalkboard exceed 20 per cent even with the accumulated chalk dust. Light boards of 50 to 75 per cent reflectance, used with dark crayon or chalk, are also being used. The 15 to 30 per cent values recommended for floors are a practical range in which light natural-finished wood floors or light coloured composition floor coverings can be maintained.

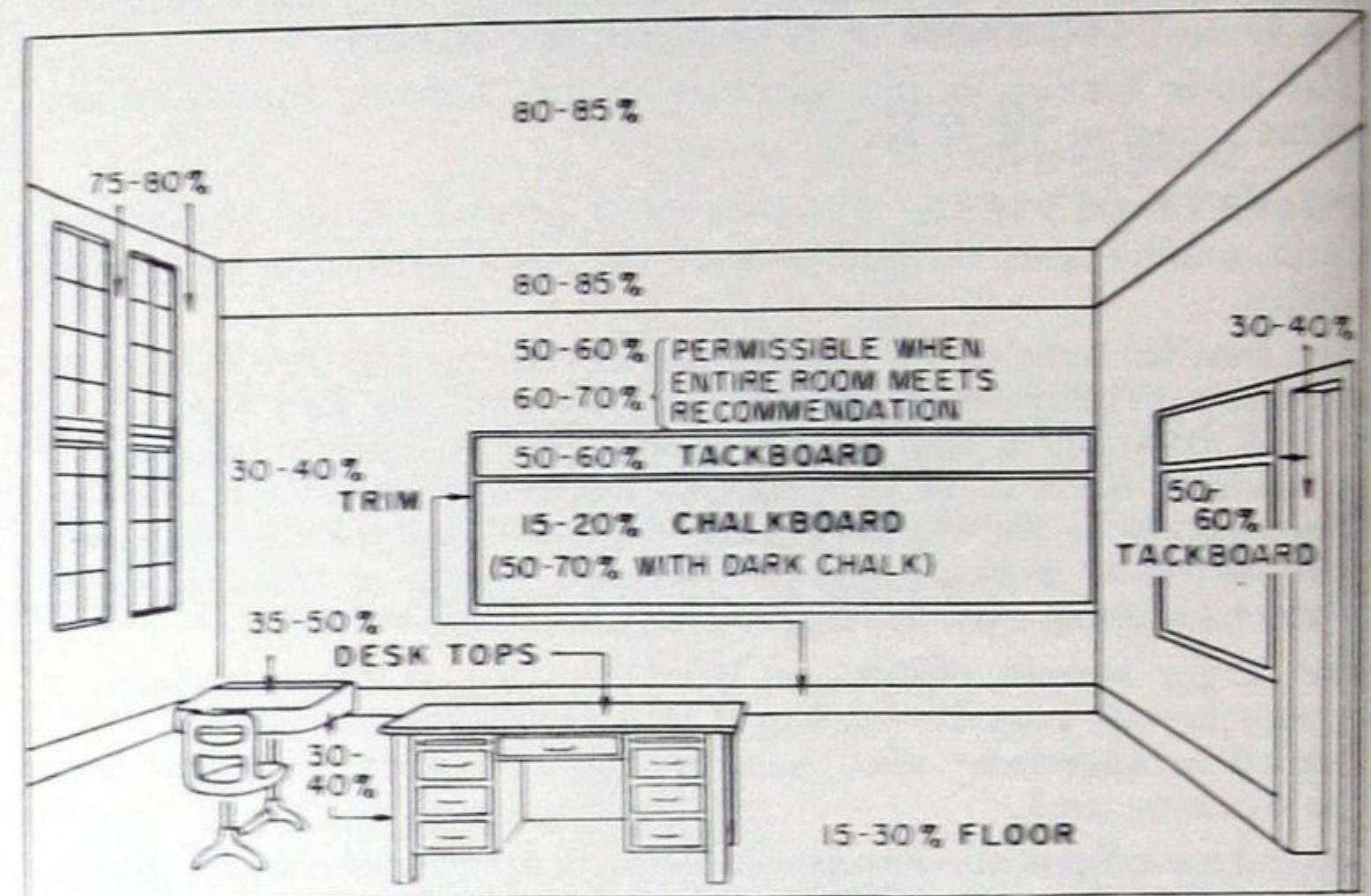

Illuminating Engineering Society—Lighting Handbook 2nd Edition.
INITIAL VALUE REFLECTANCE FACTORS DESIRABLE FOR SCHOOLROOM SURFACES.

GENERAL LIGHTING—A wide range of incandescent and fluorescent luminaires are currently available for good classroom lighting. The general diffusing type incandescent unit, such as the enclosing globes of various sizes, are not to be generally recommended, as it is not possible to provide the level of illumination required without exceeding the brightness limits suggested. Direct type incandescent lighting is also to be avoided because of excessive direct and reflected glare which may result.

The most common units used in classrooms include indirect, semi-indirect and semi-direct incandescent or fluorescent units and direct type fluorescent troffers. The selection of any such units, however, must take into consideration brightness factors and adequate shielding. A wide selection of these types of units will be found in the Commercial sections of the catalogue, together with pertinent technical data.

Sight-Saving Classrooms—Some schools use special classrooms for students with defective vision and in such cases the amount of illumination provided should be higher than for standard classrooms, at least 50 footcandles, in order to compensate to some extent for deficiencies in seeing.

In such cases, extra care should be taken to ensure that the best possible seeing conditions are provided in quality and quantity of illumination, that conditions will permit.

Sewing-Rooms—The fine detail work involved, variations in texture of material and conditions of poor contrast between sewing thread and materials make the work in sewing rooms extremely exacting and fatiguing, if high values of illumination are not provided. A minimum of 50 footcandles is recommended and the light should be well shielded and provide directional control in order that no reflected glare from the bright parts of the machine reaches the eye of the worker.

Lecture-Rooms—It is often desirable to provide switching control of the lighting units in lecture rooms to provide flexibility. For note taking or examinations, an illumination level of 30 footcandles of general lighting should be provided, whereas a lower foot-candle level, except in the lecture area, may be desirable when it is required to focus attention on the lecturer or specific demonstrations. For the presentation of lantern slides or films, a system of pin-point downlights, providing a small area of light over each desk for note taking, has also been used successfully.

Art-Rooms—The type of light source used in an art-room should render all colours as naturally as possible. Incandescent lamps emphasize yellows and reds, some fluorescent lamps emphasize the blues, others are available, however, which although slightly less efficient provide good colour rendition. Where colour rendition is of importance, the level of illumination should be in the order of 50 footcandles or more.



DESIGN DATA FOR COMMERCIAL LIGHTING

TABLE VII. RECOMMENDED LIMITS OF BRIGHTNESS RATIOS FOR CLASSROOMS†

Between the seeing task and its visually adjacent background*.....	3 to 1
Between the seeing task and the visually more remote darker surfaces.....	10 to 1
Between the seeing task and visually more remote lighter surfaces.....	1 to 10
Between luminaire or window and visually adjacent surfaces (Note also limiting luminaire brightnesses, Table VI).....	20 to 1

*For chalkboards and certain art and shop tasks the reverse ratio of 1 to 3 may apply.
 †Illuminating Engineering Society—Lighting Handbook 2nd Edition.

CHALKBOARD ILLUMINATION—Wherever chalkboards or tackboards are used extensively, care must be taken to ensure adequate vertical illumination on these surfaces. It should be remembered that the recommended values of illumination given in Table I when arrived at by the lumen method of calculation consider a horizontal work plane 30 to 36 inches above the floor. The amount of illumination provided on the vertical surfaces from a good general lighting layout may be one-third to one-half of the general lighting value. With 30 footcandles of general

illumination in a classroom, an additional 15 to 20 footcandles will be required in the chalkboard areas to provide an illumination value of 30 footcandles on the vertical surface. Directional type units may be used mounted in close proximity to the boards to supplement the general lighting in the areas in which chalkboards or tackboards are located. Illumination values on vertical surfaces are more accurately obtained by the point-by-point method of calculation, discussed in the Basic Design Data Section.

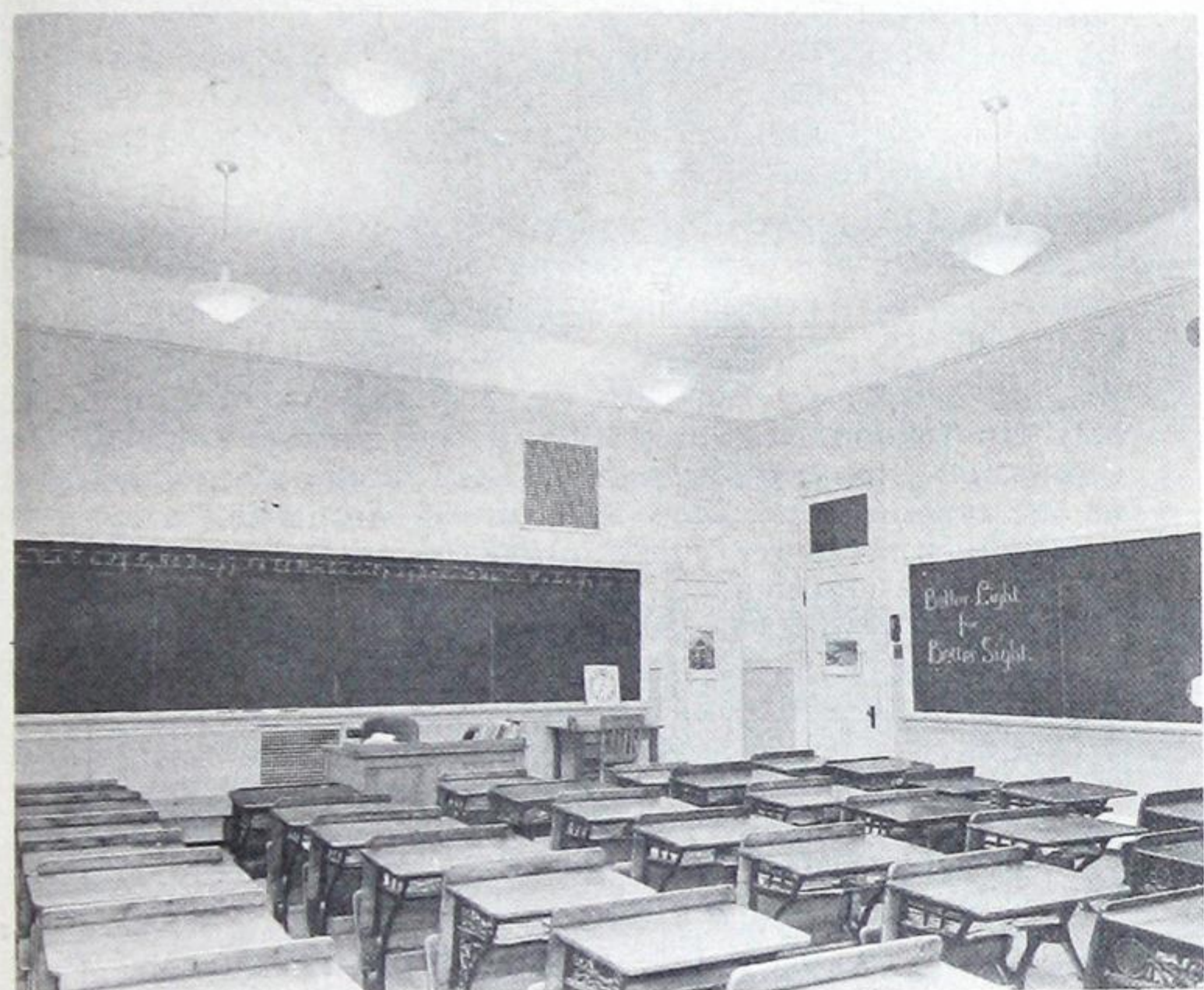

SEMI-INDIRECT LIGHTING SYSTEM, 500W INCANDESCENT LAMPS.

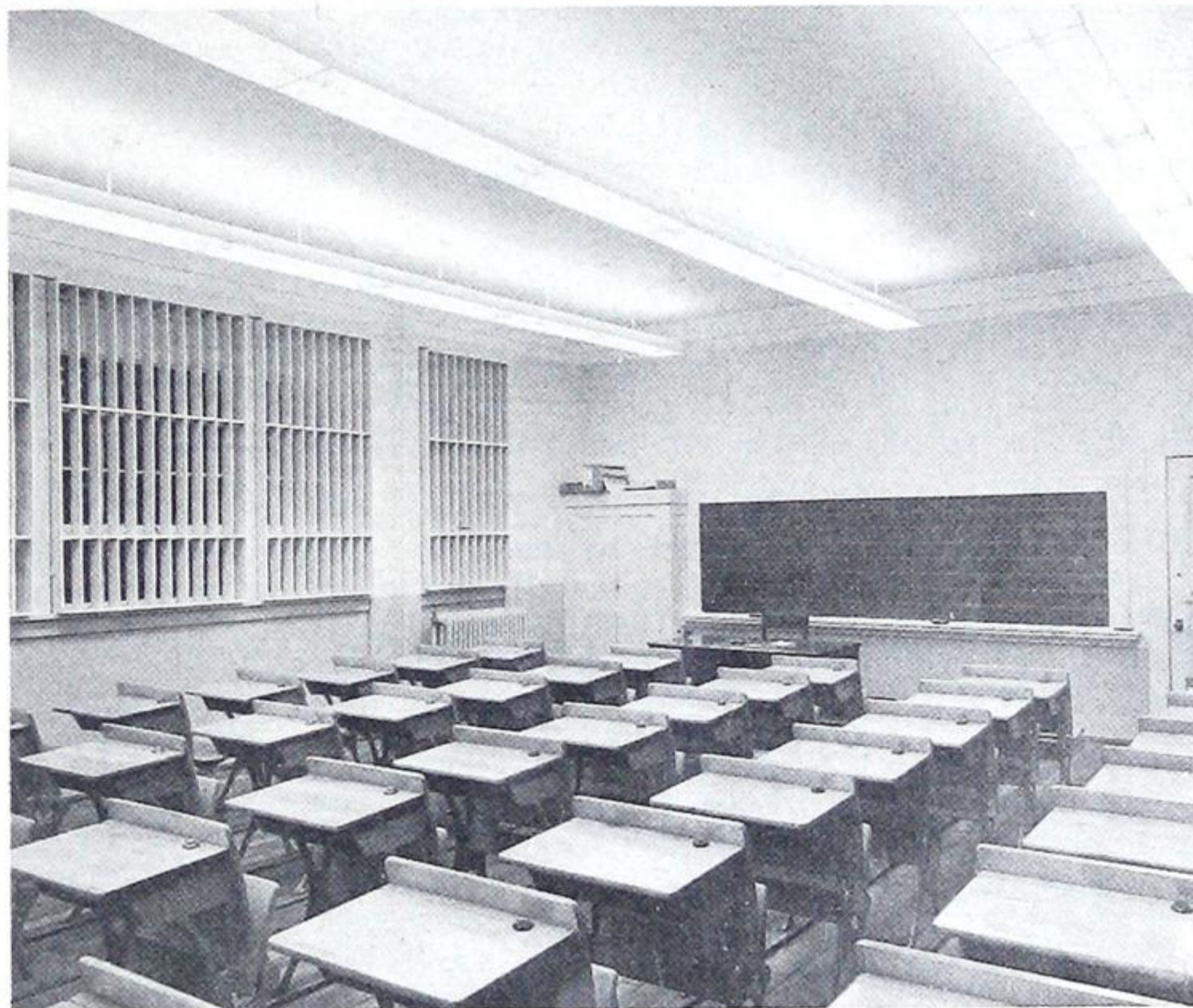

SEMI-DIRECT LIGHTING SYSTEM, 2 x 40W LUMINAIRE.

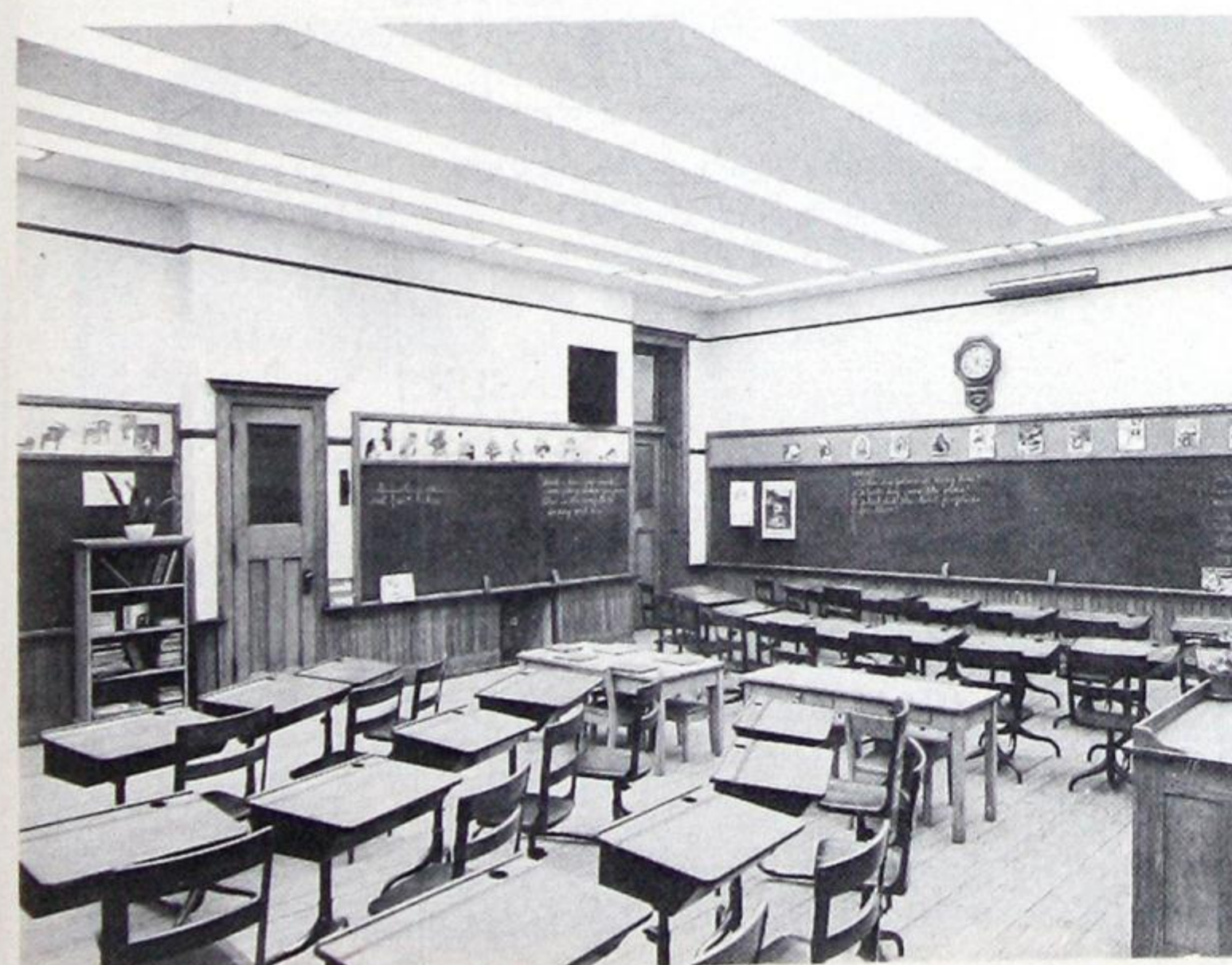

DIRECT LIGHTING SYSTEM—RECESSED FLUORESCENT TROFFERS WITH DIRECTIONAL INCANDESCENT UNITS FOR CHALKBOARD LIGHTING.

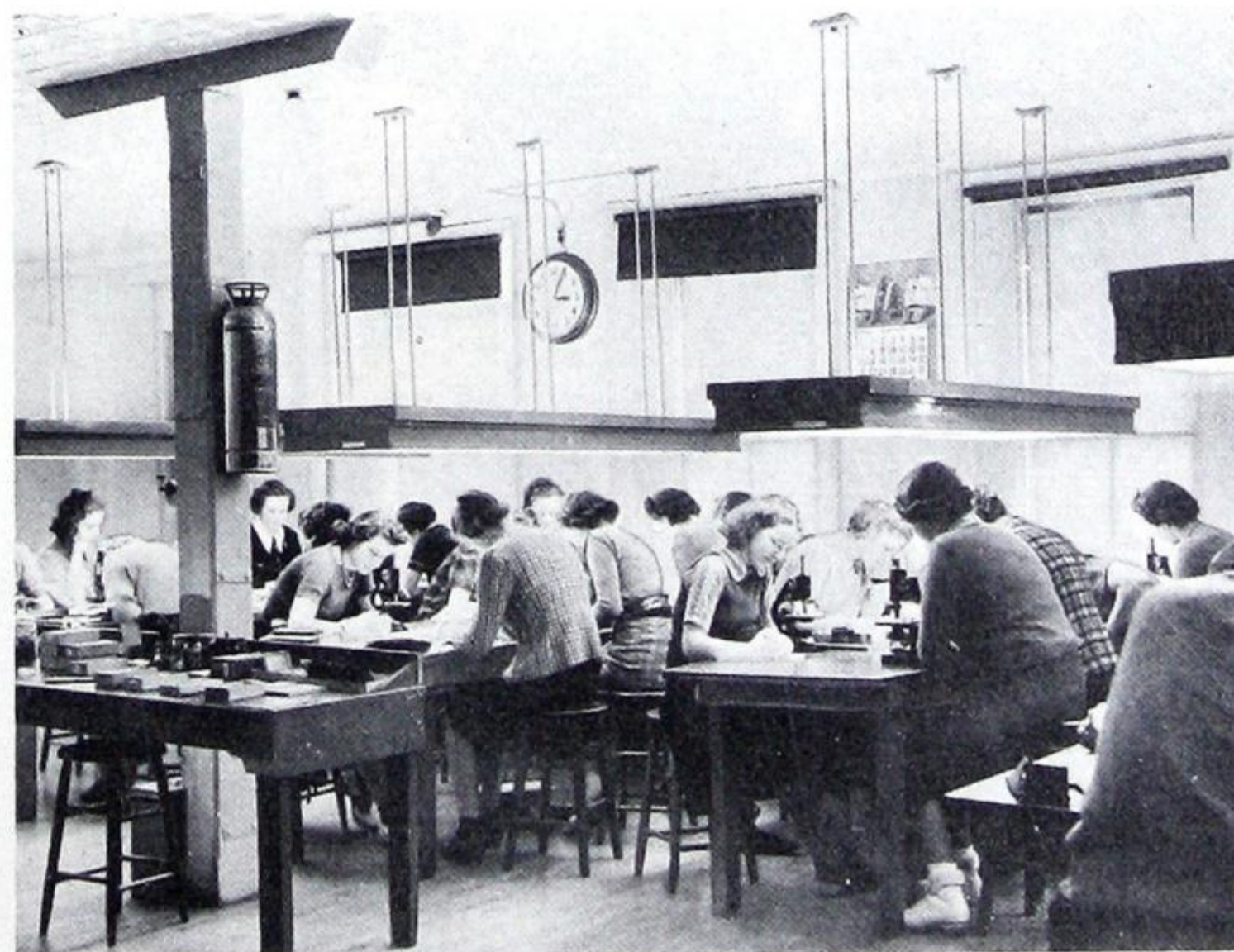

Illuminating Engineering Society—Lighting Handbook 2nd Edition. SPECIAL LIGHTING—SUPPLEMENTARY LUMINAIRE PROVIDING EVENLY DIFFUSED SHADOWLESS LIGHTING OVER WORK AREA.



DESIGN DATA FOR COMMERCIAL LIGHTING

Store Lighting

The lighting of stores, ranging from the very small businesses to large departmental stores having a wide range of commodities and different methods of merchandising, calls for a broad application of the art and science of illuminating engineering.

Merchandise is displayed in many different positions and lighting must be provided for horizontal, vertical, and oblique displays. Colours change throughout the spectrum and methods of merchandising vary from the display of quantities of fast-moving items to individual exclusive products. Size, texture and finish differ from large shaggy carpets and highly polished automobiles to small precious stones and costume jewellery. Layout of equipment may be flexible or permanent, and the store exclusive in design or otherwise.

All of these factors must be considered and their relation to the prime purpose of lighting in stores which is to help sell merchandise (Table VIII) must be determined.

The scope of this section allows nothing more than a generalisation of the problems involved and an indication of the lighting tools available. The application of this equipment to the many individual problems requires skill and experience, an understanding of merchandising methods and a knowledge of display techniques. The successful planning of store lighting requires close co-operation between the architect, store designer, lighting engineer and display man.

It is essential also that lighting considerations be given a great deal of thought in the initial planning of new stores.

LIGHTING TECHNIQUES—For most stores, irrespective of size and style, a basic lighting technique may be followed. This divides the lighting requirements into five functional applications, which require individual considerations for the particular type or types of merchandise handled, but if properly applied, add up to lighting for selling which will bring lucrative results.

These five considerations are as follows:

- (1) *Lighting for Stock Rooms*—A level of illumination in the order of ten foot-candles is usually sufficient for stock rooms and in most cases standard or directional type industrial units are used depending upon the nature of the merchandise and storage methods.
- (2) *Circulation Areas*—Aisles and corridors or general circulation areas should be lighted to an intensity of approximately

twenty footcandles to ensure the safety and security of customers, reducing the possibility of accidents and risks of thievery.

- (3) *General Merchandising Areas*—In these areas, the level of illumination should be approximately two to three times that of the circulation area. This forms a general or uniform lighting system and a foundation for additional directional effect, or attraction lighting features. Lighting of the general merchandising areas should take into consideration the type merchandise on display and the relative value of horizontal and vertical illumination values. Luminous ceilings or panels, artificial skylights, luminous coffers, recessed troffers and conventional luminaires may all be used in one form or another for the lighting of circulation and general merchandising areas.
- (4) *Basic Displays*—These include show cases, wall cases, open-counter displays, etc. to which the customer's attention should be directed. To provide the extra attraction values in these areas, footcandle values, approximating five times that of the circulation area, is desirable.

This is usually achieved by localized or local lighting by supplementary luminaires in the form of show-case units, built-in valances, spotlights, floodlights, etc. Such arrangements may create interesting shadows and highlights and emphasize the texture, lustre, sparkle and workmanship of the product displayed.

Care should be taken to ensure that the illumination values in such areas are not more than twice that of the general counter area when goods are removed from display for handling.

- (5) *Feature Displays*—For feature displays where maximum attraction value is required, the lighting may be as intense or dramatic as necessary and the level of illumination should be in the order of ten times that of the circulation area, 200 footcandles or more. High intensities with directional control are best obtained with spotlight units, some of which have a great deal of flexibility for changing the location of the light beam or to allow several units to be directed in a specific area. This high intensity lighting may be supplemented by luminous architectural features, coves, etc. for background lighting with a great deal of effectiveness.

TABLE VIII

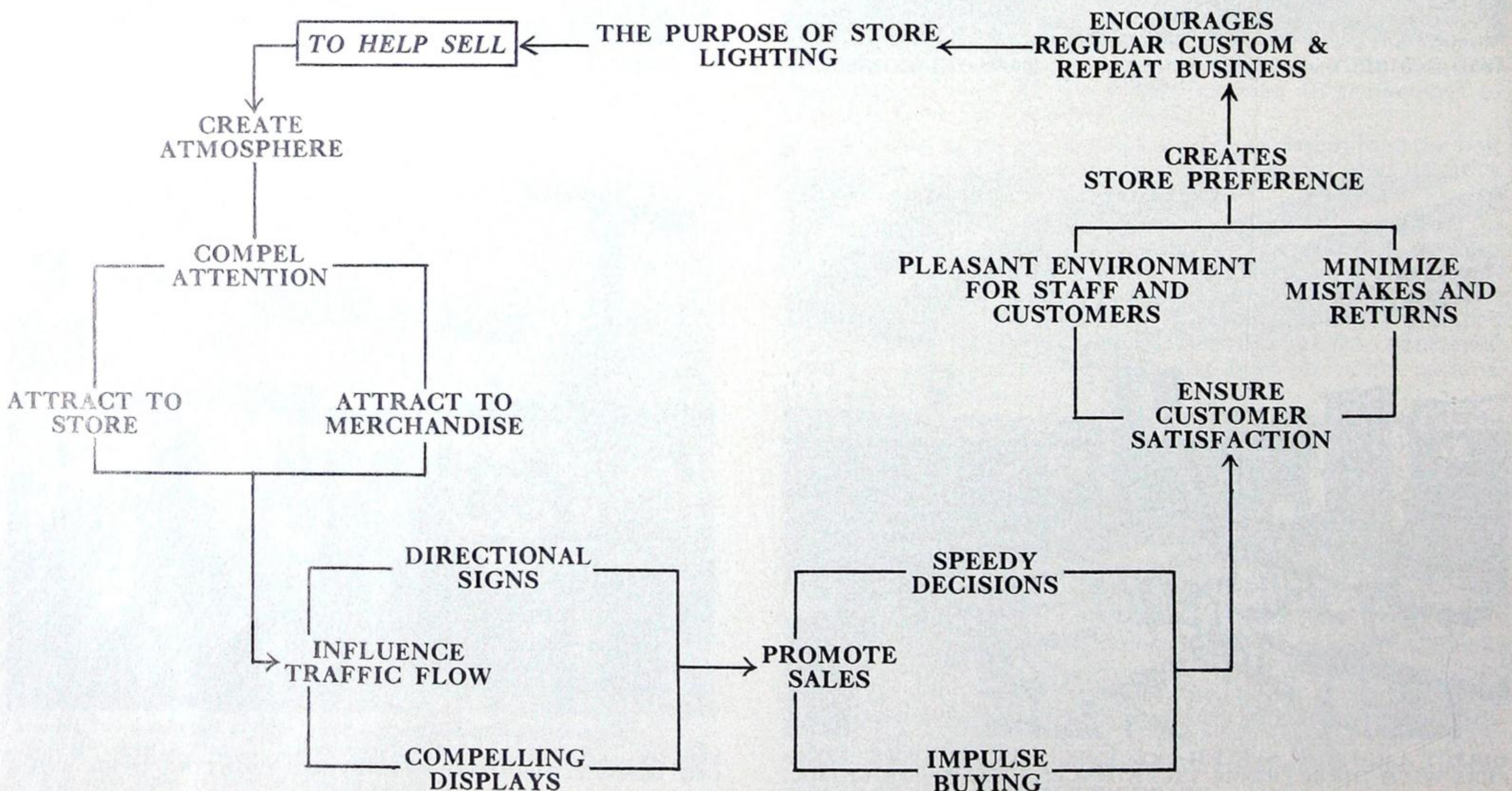



DESIGN DATA FOR COMMERCIAL LIGHTING

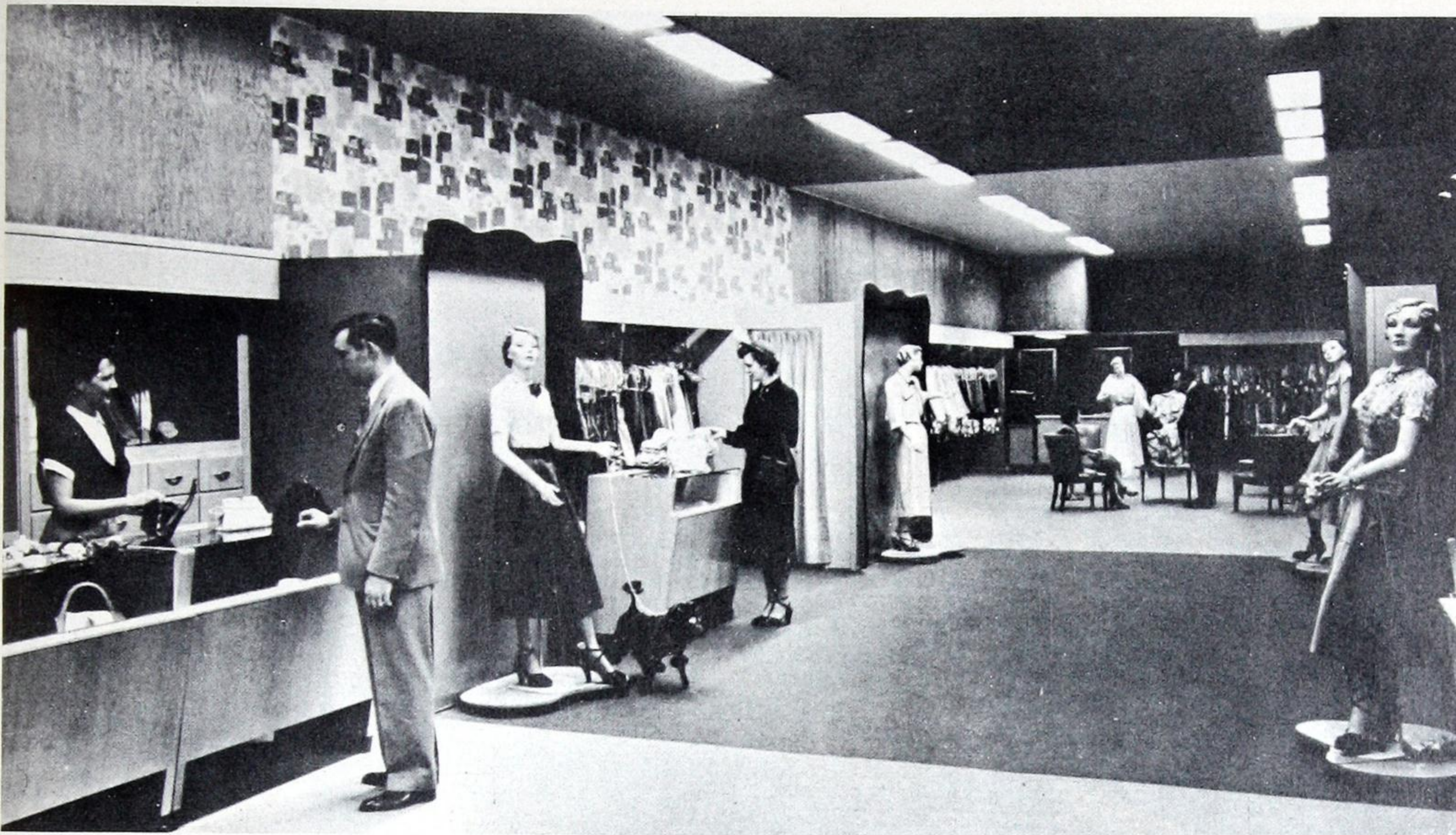

CIRCULATION AREAS AND GENERAL MERCHANDISING AREAS—The basic interior illumination varies in the store illustrated from 50 footcandles on the counter to 30 footcandles in center of the circulation zones, due to logical luminaire location. The ceiling elements are direct, recessed, louvered, housing 3-40 watt fluorescent lamps. This basic system alone provides illumination but results in relatively uninteresting room appearance; the effect is flat and uninteresting.



(Photos) Illuminating Engineering Society Lighting Handbook 2nd Edition.

BASIC DISPLAYS—The basic displays, the wall cases and counter displays add some light to the general merchandising areas. They attract attention to the selling zone and in some instances provide upward light revealing architectural features.

COMMERCIAL LIGHTING
INCANDESCENT

DESIGN DATA FOR COMMERCIAL LIGHTING

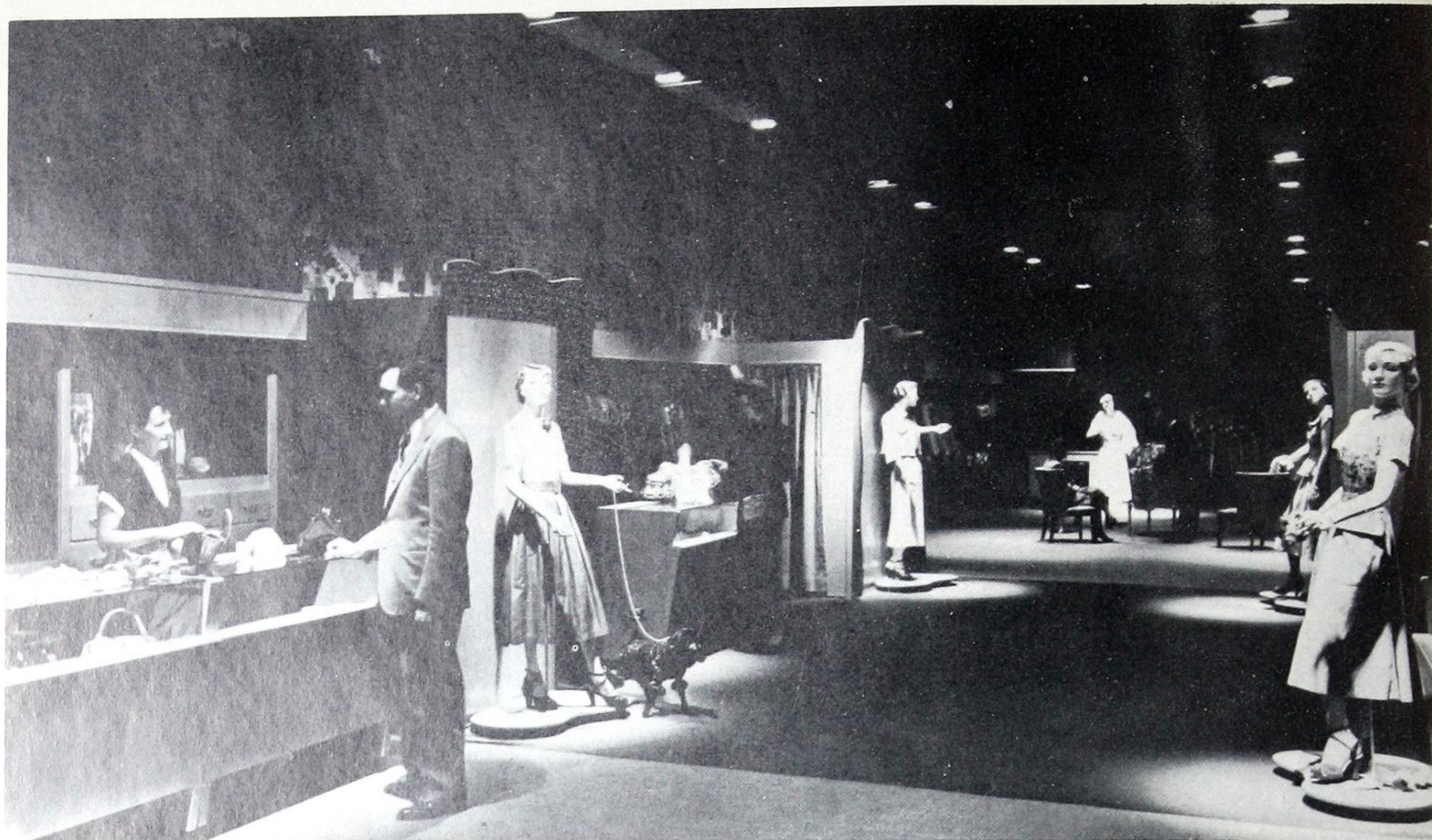

FEATURE DISPLAYS—Recessed ceiling spotlights provide high intensities of illumination highlighting feature displays and attract attention to different parts of the store.



(Photos) Illuminating Engineering Society Lighting Handbook 2nd Edition.

COMBINED EFFECT—All elements of interior lighting are here combined for complete lighting for merchandising. Peak values are on sales areas; quality is excellent with both diffused and directed light—as desirable for better appraisal of goods. Atmosphere is bright and attractive. Basic and feature displays have higher brightness with consequent greater appeal. (Note contribution to ceiling brightness of light reflected from below).



DESIGN DATA FOR COMMERCIAL LIGHTING

Table IX. Room Index Table

		CEILING HEIGHT—FEET										
Semi-Indirect and Indirect Lighting.		9 to 9½	10 to 11½	12 to 13½	14 to 16½	17 to 20	21 to 24	25 to 30	31 to 36	37 to 50		
		MOUNTING HEIGHT ABOVE FLOOR—FEET										
Direct, Semi-Direct, General Diffuse, and Direct-Indirect Lighting.		7 to 7½	8 to 8½	9 to 9½	10 to 11½	12 to 13½	14 to 16½	17 to 20	21 to 24	25 to 30	31 to 36	37 to 50
Room Width (Feet)	Room Length (Feet)	ROOM INDEX										
9 (8½-9)	8-10	H	I	J	J	J	J	J	J	J		
	10-14	H	I	J	J	J	J	J	J	J		
	14-20	G	H	I	J	J	J	J	J	J		
	20-30	G	H	I	J	J	J	J	J	J		
	30-42	G	H	I	J	J	J	J	J	J		
10 (9½-10½)	42-Up	E	F	G	H	I	J	J	J	J		
	10-14	G	H	I	J	J	J	J	J	J		
	14-20	G	H	I	J	J	J	J	J	J		
	20-30	G	H	I	J	J	J	J	J	J		
	30-42	G	H	I	J	J	J	J	J	J		
12 (11-12½)	42-60	F	G	H	I	J	J	J	J	J		
	60-90	F	G	H	I	J	J	J	J	J		
	90-Up	F	G	H	I	J	J	J	J	J		
	11-14	G	H	I	J	J	J	J	J	J		
	14-20	G	H	I	J	J	J	J	J	J		
14 (13-15½)	20-30	F	G	H	H	I	J	J	J	J		
	30-42	F	G	H	H	I	J	J	J	J		
	42-60	F	G	H	H	I	J	J	J	J		
	60-90	F	G	H	H	I	J	J	J	J		
	90-Up	F	G	H	H	I	J	J	J	J		
17 (16-18½)	10-14	E	F	G	H	I	J	J	J	J		
	14-20	E	F	G	H	I	J	J	J	J		
	20-30	E	F	G	H	I	J	J	J	J		
	30-42	E	F	G	H	I	J	J	J	J		
	42-60	E	F	G	H	I	J	J	J	J		
20 (19-21½)	60-110	D	E	F	G	H	I	J	J	J		
	110-Up	D	E	F	G	H	I	J	J	J		
	19-30	D	E	F	G	H	I	J	J	J		
	30-42	D	E	F	G	H	I	J	J	J		
	42-60	D	E	F	G	H	I	J	J	J		
24 (22-26)	60-90	C	D	E	F	G	H	I	J	J		
	90-140	C	D	E	F	G	H	I	J	J		
	140-Up	C	D	E	F	G	H	I	J	J		
	22-30	D	E	E	F	G	H	I	J	J		
	30-42	D	E	E	F	G	H	I	J	J		
30 (27-33)	42-60	C	D	D	E	F	G	H	I	J		
	60-90	C	D	D	E	F	G	H	I	J		
	90-140	C	D	D	E	F	G	H	I	J		
	140-180	C	D	D	E	F	G	H	I	J		
	180-Up	C	D	D	E	F	G	H	I	J		
36 (34-39)	180-Up	B	C	D	E	F	F	H	I	J		
	34-42	B	C	D	E	F	F	H	I	J		
	42-60	B	C	D	E	F	F	H	I	J		
	60-90	B	C	D	E	F	F	H	I	J		
	90-140	B	C	D	E	F	F	H	I	J		
42 (40-50)	140-200	A	B	C	C	E	F	G	H	I		
	200-Up	A	B	C	C	E	F	G	H	I		
	40-60	A	B	C	C	E	F	G	H	I		
	60-90	A	B	C	C	E	F	G	H	I		
	90-140	A	B	C	C	E	F	G	H	I		
50 (46-55)	140-200	A	A	B	C	D	E	F	G	H		
	200-Up	A	A	B	C	D	E	F	G	H		
	46-60	A	A	B	C	D	E	F	G	H		
	60-90	A	A	B	C	D	E	F	G	H		
	90-140	A	A	B	C	D	E	F	G	H		
60 (56-67)	140-200	A	A	A	B	C	D	E	F	G		
	200-Up	A	A	A	B	C	D	E	F	G		
	56-90	A	A	A	B	C	D	E	F	G		
	90-140	A	A	A	B	C	D	E	F	G		
	140-200	A	A	A	B	C	D	E	F	G		
75 (68-90)	140-200	A	A	A	A	B	C	D	E	F		
	200-Up	A	A	A	A	B	C	D	E	F		
	68-90	A	A	A	A	B	C	D	E	F		
	90-140	A	A	A	A	B	C	D	E	F		
	140-200	A	A	A	A	B	C	D	E	F		
90 or more	90-140	A	A	A	A	A	B	C	D	E		
	140-200	A	A	A	A	A	B	C	D	E		
	200-Up	A	A	A	A	A	B	C	D	E		

WHAT COLOUR LAMPS?

TO OBTAIN	USE
Best match with filament lighting.....	DeLuxe Warm White
Smooth blend with natural daylight.....	Standard Cool White
All Colours at their best.....	DeLuxe Warm White
Most light per dollar (high efficiency).....	Standard Warm White
Warm mellow effect with highest eff:.....	Standard Warm White
Cool neutral effect with highest eff:.....	Standard Cool White
Excellent rendition of colours—cool atmosphere.....	DeLuxe Cool White
Excellent rendition of colours—warm atmosphere.....	DeLuxe Warm White
Accent of warm colours, reds, yellow, orange.....	DeLuxe Warm White
Accent of cool colours, Blues, greens, greys and at the same time reds.....	DeLuxe Cool White

COMMERCIAL LIGHTING
INCANDESCENT



SILVER BOWL INDIRECT UNITS

Design

The Silver Bowl Indirect Luminaire has set a new standard in lighting equipment design. With the Silvered Bowl lamp, bulky reflectors are eliminated, units are simple in line and graceful in appearance. Advantage is taken of newer decorative materials such as plastics, combination of metal and glass, and louvered shielding to produce beauty in design and high maintained efficiency.

Simplicity

An attractive advantage of Silver Bowl Units is the simplicity of handling relamping. There is no need for taking the fixture apart, lowering the bowl or handling parts when relamping. The Silvered Bowl lamp, extending through the centre of the unit, is quickly inserted or removed.

Depreciation

One principal objection to the general acceptance of indirect lighting has been the reflector maintenance problem. It was both costly and troublesome. Failure to clean exposed reflecting surfaces at frequent intervals resulted in a serious reduction in needed illumination and a waste of purchased electricity.

With Silver Bowl Units, dust and dirt cannot reach the light-reflecting surface because the reflector is hermetically sealed to the bowl of the lamp, thus assuring constant maintenance of reflector efficiency.

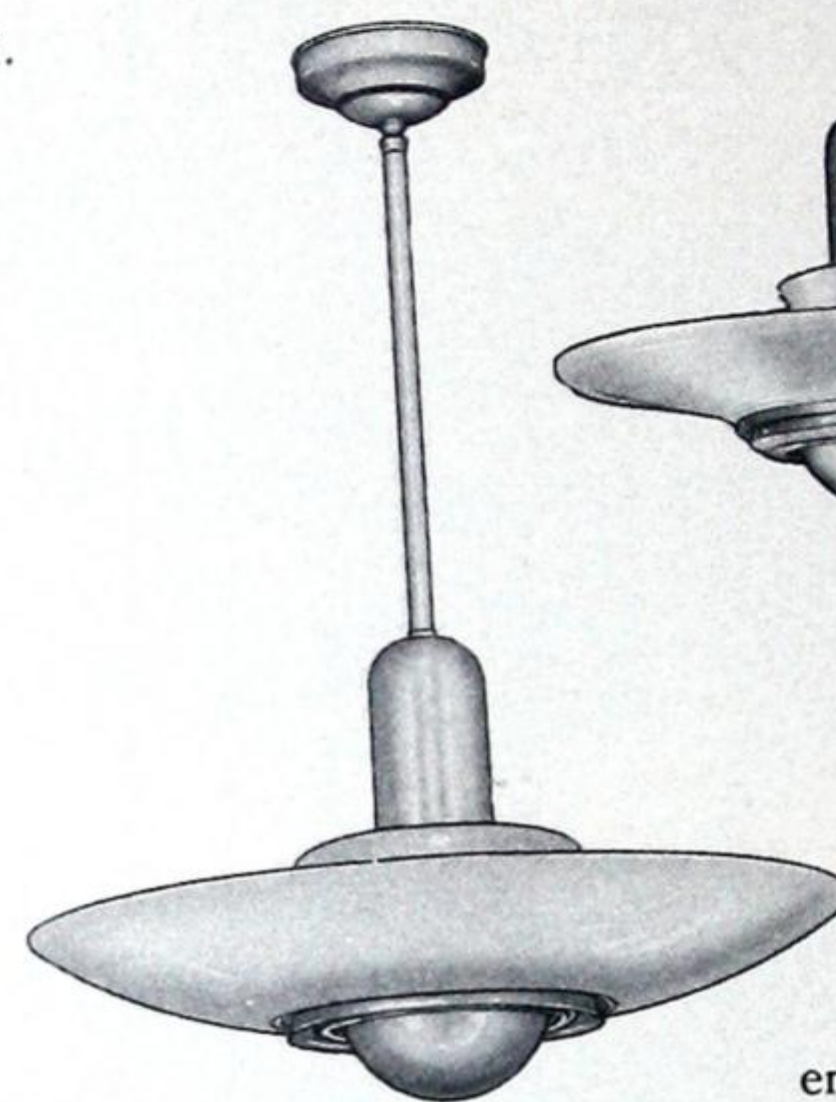
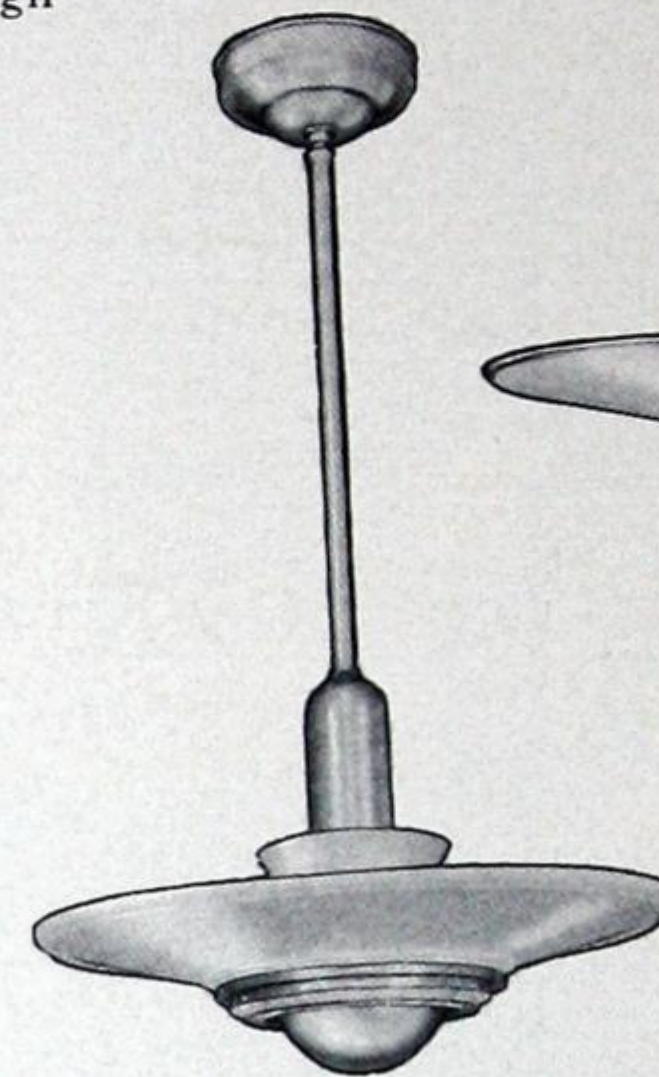
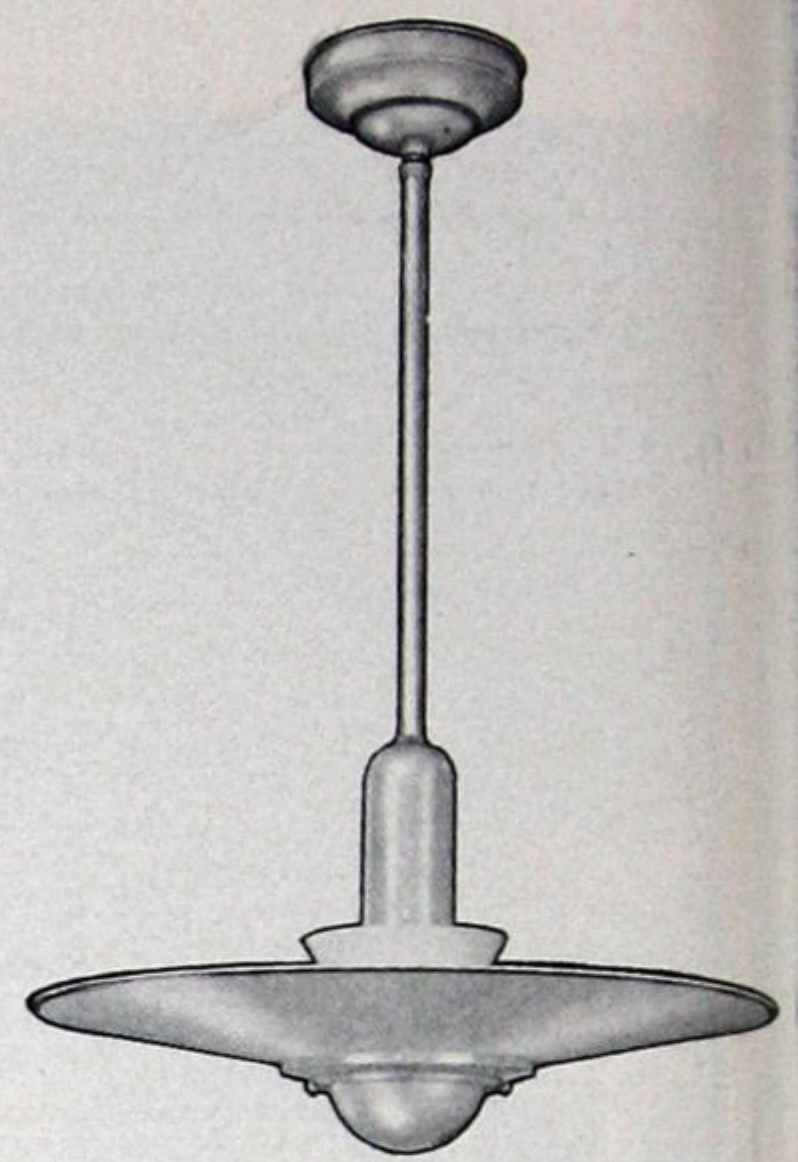

Maintenance

A substantial increase in lighting efficiency may be expected over the entire life period of the Silvered Bowl lamps, as compared with equipment depending upon reflectors whose surfaces are exposed to dust, insects and normal depreciation. Under normal conditions Silver Bowl Units need to be cleaned only at times of normal lamp replacement.

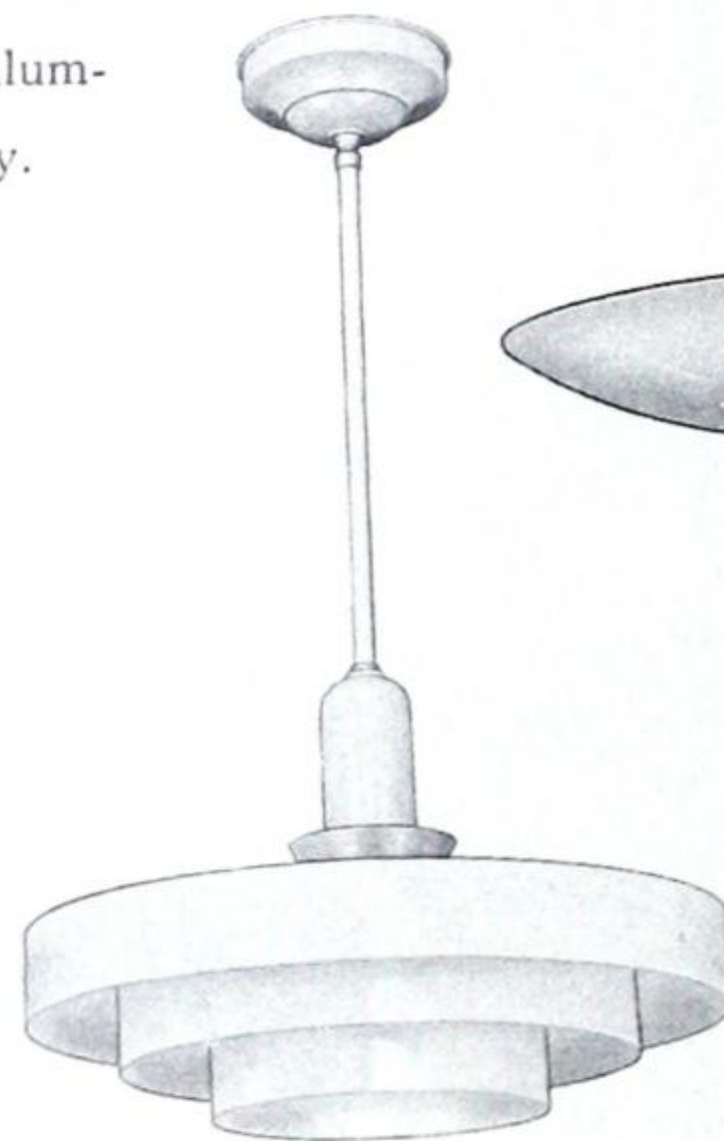

Efficiency

The problem of contemporary fixture design has been that of compromising between engineering ideas of efficiency and the buyers' ideas of good appearance. By designing around the Silvered Bowl lamp, with its inherent efficiency of light control, both beauty of design and high lighting efficiency have been achieved.

Overall Costs

In considering the purchase of lighting equipment, the problem is that of getting the most light for the lowest overall lighting cost. It has been clearly established that the value of the increased illumination provided by the Silver Bowl Units as well as the reduction in fixture and reflector maintenance expense, much more than make up for the higher initial cost of the Silvered Bowl lamp.

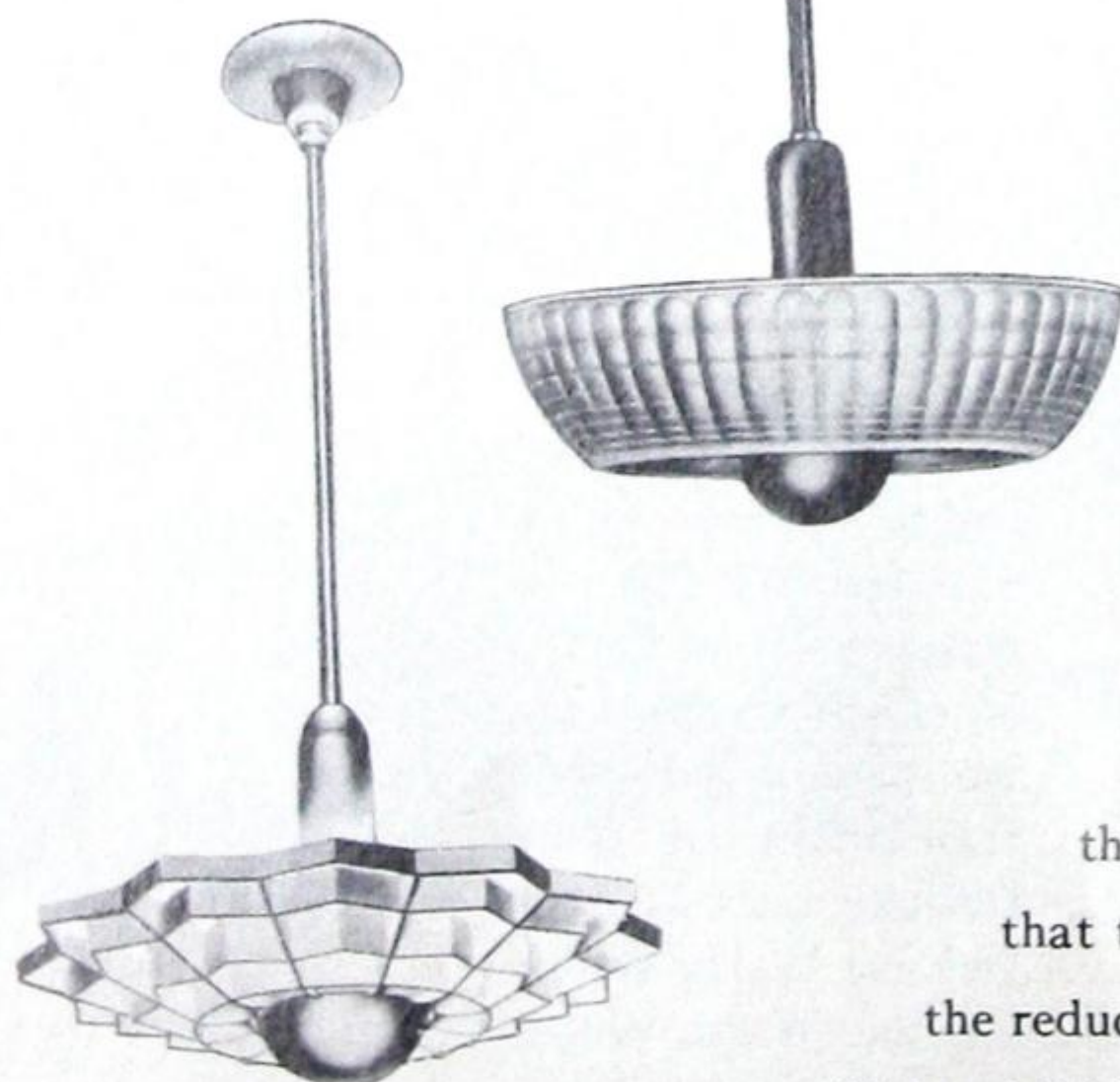



SILVER BOWL INDIRECT UNITS

Silvray "1500" Unit

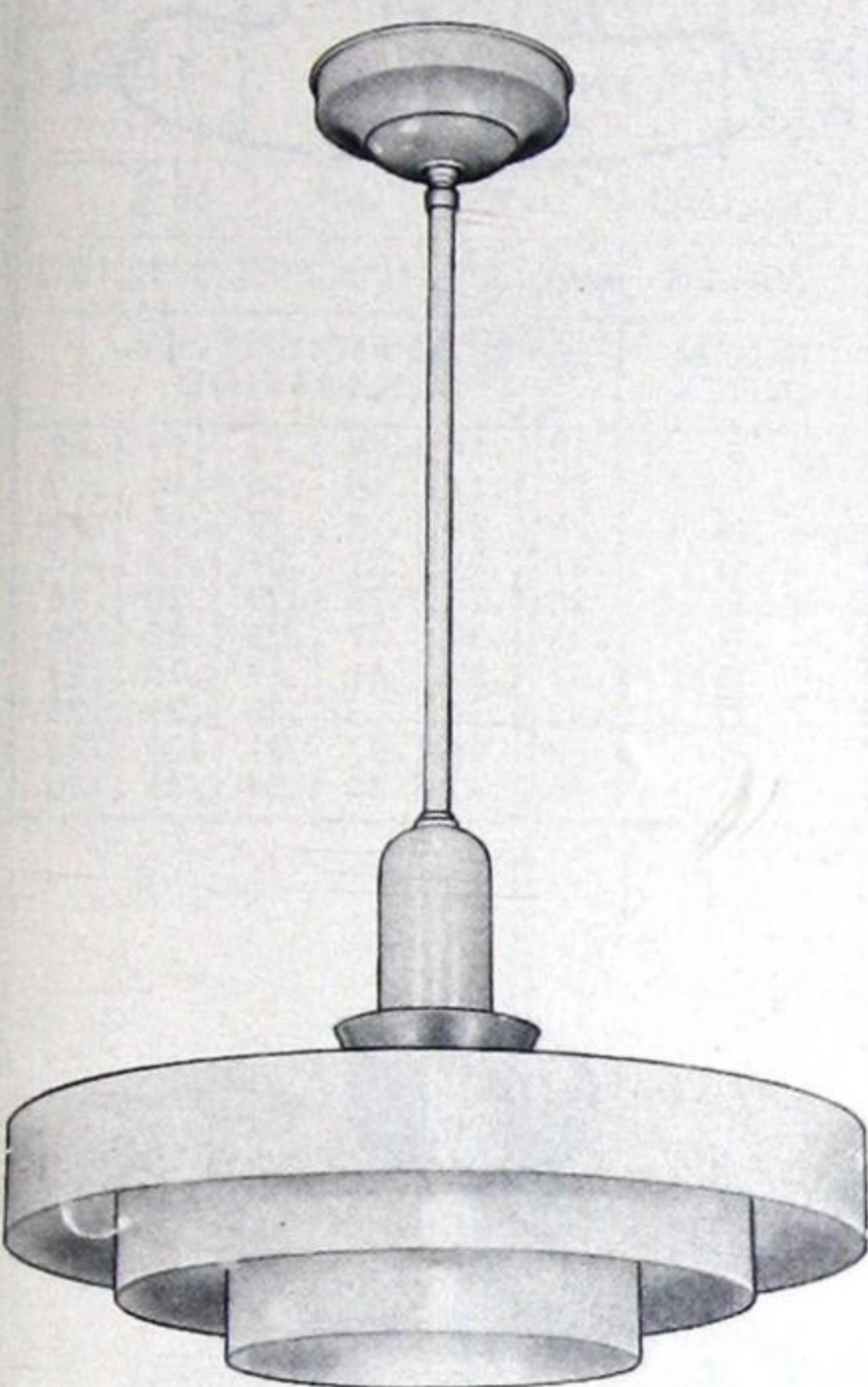

1500S/3R/5



1500/3R/5

SPACING 1.2xCH		EFF 90.0%				
M.F.		85.0%				
G.70		5.0%				
M.65						
P.55						
CEILING	75%		50%			
WALLS	50%	30%	10%	50%	30%	10%
ROOM INDEX	COEFFICIENT OF UTILISATION					
J	.19	.16	.14	.14	.12	.10
I	.23	.19	.18	.17	.15	.13
H	.26	.23	.20	.19	.16	.15
G	.29	.26	.23	.22	.19	.17
F	.32	.29	.25	.24	.21	.19
E	.35	.32	.29	.26	.23	.21
D	.39	.35	.33	.28	.26	.24
C	.41	.38	.35	.30	.27	.26
B	.45	.42	.39	.32	.31	.29
A	.47	.44	.42	.35	.32	.31

Construction

The unit consists of a hanger, either ceiling mounting or suspension type, and a body comprising three or four concentric rings or bands of metal which are welded to a tripod of supporting rods. The body is suspended from the hanger by three removable supports on which is mounted a shielding device which cuts off the excessive brightness of the upper portion of the lamp at normal viewing angles.

Simplicity

An attractive advantage of the "1500" Silver-Bowl Unit is the simplicity of re-lamping. There is no need to take the fixture apart or to dismantle any of its components when re-lamping. The Silvered Bowl lamp, extending through the center of the unit, is quickly inserted or removed.

Depreciation

One principle objection to the general acceptance of Indirect Lighting has been the reflector maintenance problem. It was both costly and troublesome. Failure to clean exposed reflecting surfaces at frequent intervals resulted in a serious reduction in needed illumination and a waste of purchased electricity. With the "1500" Silver-Bowl Unit, dust and dirt cannot reach the light reflecting surface because the reflector is hermetically sealed to the bowl of the lamp, thus assuring constant maintenance of reflector efficiency.

Light reflecting from the ceiling passes between these concentric bands of the fixture body, thus eliminating any losses which might otherwise occur. A small portion of the reflected light impinges on the metal bands and gives them a luminosity which overcomes the objectionable opaqueness usually found in totally indirect fixtures.

Maintenance

A substantial increase in lighting efficiency may be expected over the entire life of the Silvered Bowl lamps, as compared with other equipment depending upon reflectors whose surfaces are exposed to dust, insects and normal depreciation. Under normal conditions, the "1500" Silver-Bowl Unit need only be cleaned at times of normal lamp replacement.

Overall Costs

In considering the purchase of lighting equipment, the problem is that of getting the most light for the lowest overall lighting cost. It has been clearly established that the value of the increased illumination provided by the Silver Bowl Units as well as the reduction in fixture and reflector maintenance expense, much more than make up for the higher initial cost of the Silvered Bowl Lamp.

Catalogue No.	Lamp Watts Silvered Bowl	Socket Type	No. of Rings	Dimensions	
				Overall Length	Bowl Diameter
1500/3R/5	300/500	Mogul	3	14"	19"
1500S/3R/5	300/500	Mogul	3	32 1/2"	19"
1500S/4R/10	750/1000	Mogul	4	43"	24"

Hanger Finish—Satin Aluminum.
Ring Finish—Baked white enamel, flat finish.

COMMERCIAL LIGHTING
INCANDESCENT



SILVER BOWL INDIRECT UNITS
Silvray "Challenger" Units

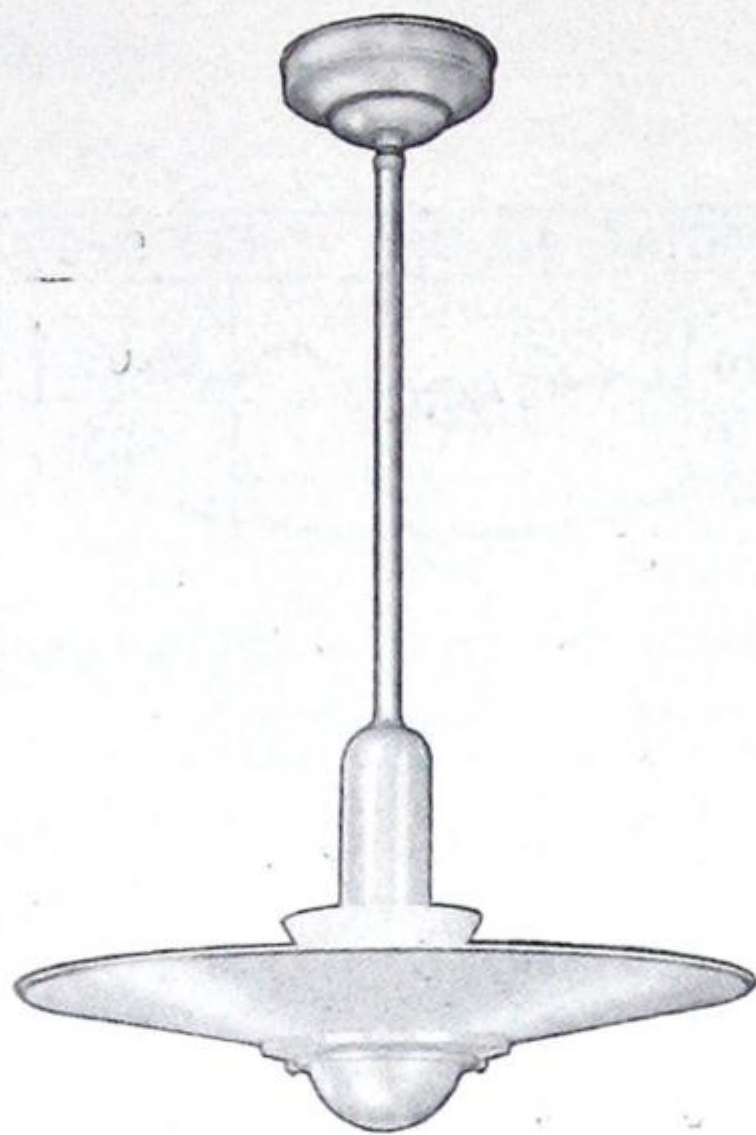

TYPE 207

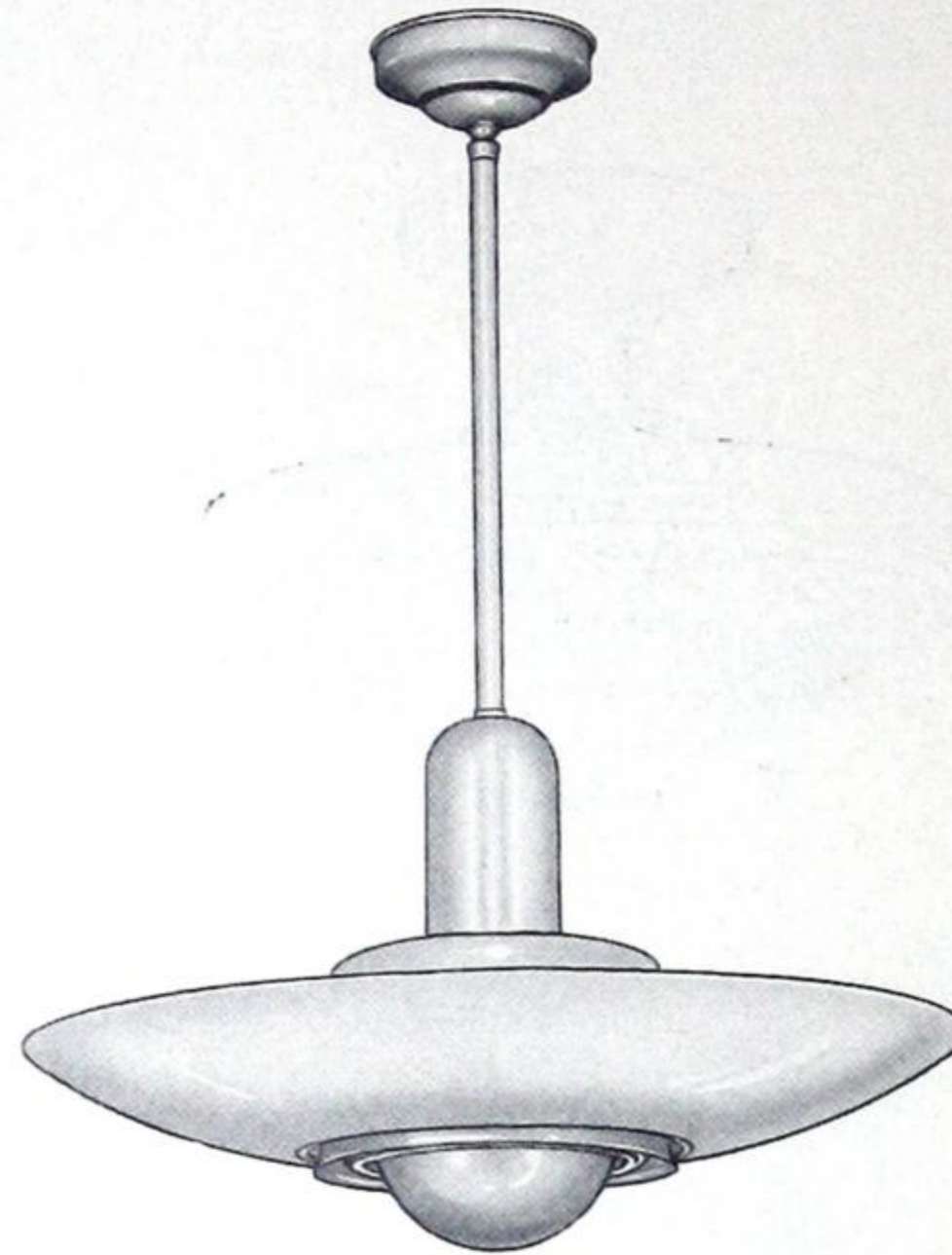

TYPE 210-PL

SPACING 1.2xCH		EFF 92.0%	
M.F.	CHALLENGER	88.5%	
G.70	"207-PL"	↑	
M.65	"210-PL"	3.5%	
P.55		↓	
CEILING	75%	50%	
WALLS	50% 30% 10%	50% 30% 10%	
ROOM INDEX	COEFFICIENT OF UTILISATION		
J	.17	.14	.12
I	.21	.17	.16
H	.24	.21	.18
G	.27	.24	.21
F	.30	.27	.23
E	.33	.30	.27
D	.37	.33	.31
C	.39	.36	.33
B	.43	.40	.37
A	.45	.42	.40

SPACING 1.2xCH		EFF 92%	
M.F.	CHALLENGER	92%	
G.70	"207"	↑	
M.65		0%	
P.55		↓	
CEILING	75%	50%	
WALLS	50% 30% 10%	50% 30% 10%	
ROOM INDEX	COEFFICIENT OF UTILISATION		
J	.20	.17	.15
I	.24	.20	.19
H	.27	.24	.21
G	.30	.27	.24
F	.33	.30	.26
E	.36	.33	.30
D	.40	.36	.34
C	.42	.39	.36
B	.46	.43	.40
A	.48	.45	.43

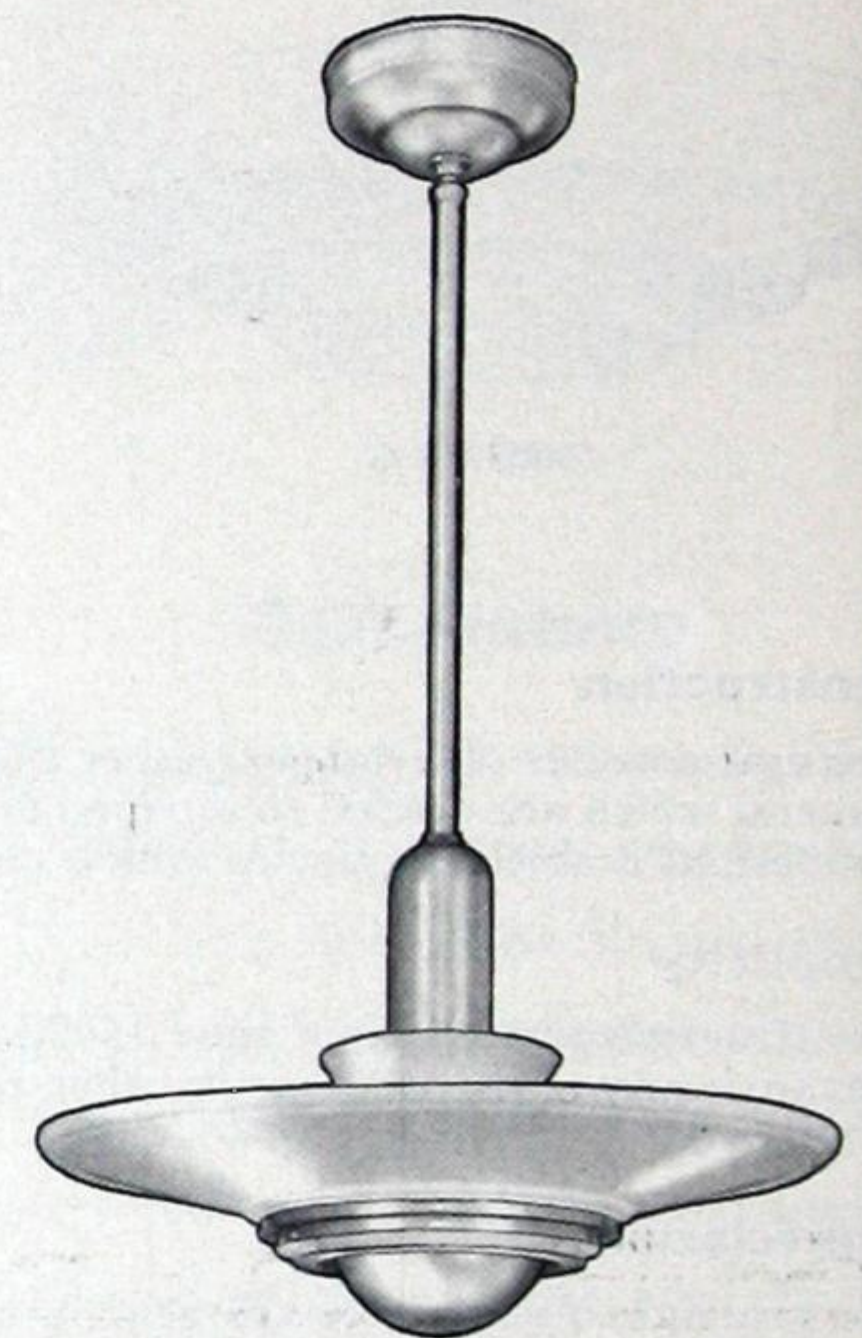

TYPE 207-PL

No. 207—This fixture, although low in cost, is the most efficient indirect lighting unit yet devised. It is particularly suited for use in areas where efficiency of the lighting system is the primary consideration—such as in accounting and clerical offices, drafting and school rooms. Constructed of triple plated, heavy guage copperized steel. Standard finish—satin aluminum. Self-aligning swivel joint in suspension assures correct alignment.

No. 207-PL and No. 210-PL—Designed for good lighting, and combining the best features of plastic and metal, these translucent plastic fixtures lend a pleasing appearance and provide the essential characteristics in luminaire design requirements which produce glare-free seeing conditions.

Both fixtures consist of canopy, swivel hanger, slender tubular metal stem, socket, husk, rod support, molded plastic basin, and lamp baffle. Plated ring louvers separate the plastic basin from the lamp.

Catalogue No.	Lamp Watts Silvered Bowl	Socket Type	Dimensions	
			Overall Length	Bowl Diameter
207/5	300/500	Mogul	28½"	20"
207/10	750/1000	Mogul	40"	25"
207-PL/5	300/500	Mogul	28½"	18"
210-PL/5	300/500	Mogul	28½"	18"
210-PL/10	750/1000	Mogul	40"	25"



SILVER BOWL INDIRECT UNITS

SPACING 1.2xCH		EFF 89.5%				
M.F.	"SNO-FLAKE"	88.0%				
G.80		1.5%				
M.75						
P.60						
CEILING	75%		50%			
WALLS	50%	30%	10%	50%	30%	10%
ROOM INDEX	COEFFICIENT OF UTILISATION					
J	.17	.13	.11	.11	.09	.08
I	.21	.18	.15	.15	.12	.10
H	.25	.21	.18	.16	.14	.12
G	.29	.24	.21	.20	.16	.15
F	.31	.27	.24	.22	.18	.16
E	.36	.31	.28	.24	.21	.19
D	.39	.35	.32	.26	.23	.21
C	.42	.38	.35	.28	.25	.23
B	.46	.42	.39	.30	.29	.27
A	.48	.45	.42	.33	.30	.29

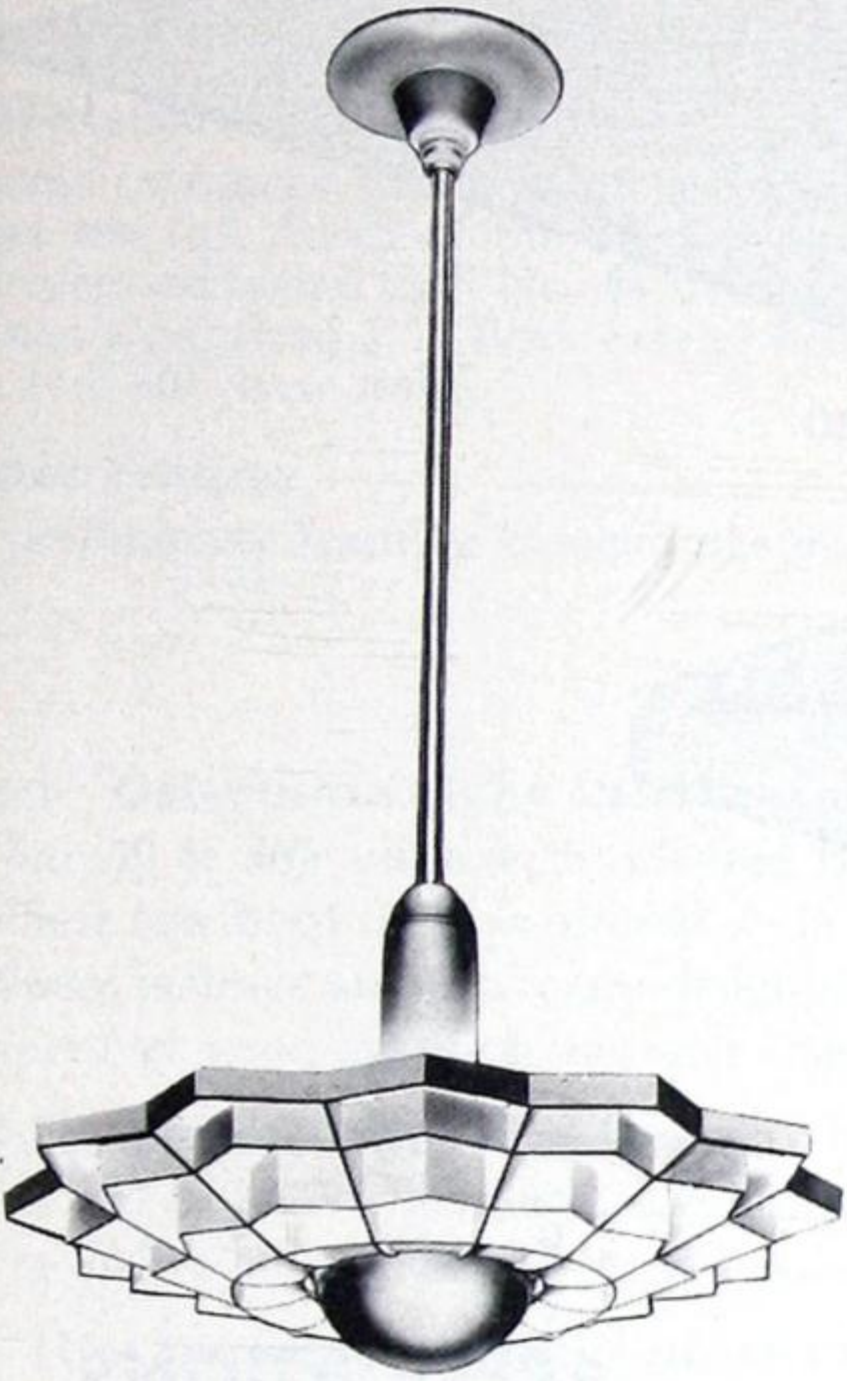

CURTIS "SNO-FLAKE"

SPACING 1.2xCH		EFF 89.0%				
M.F.	S 5630 S 5640	84.5%				
G.80		4.5%				
M.70						
P.60						
CEILING	75%		50%			
WALLS	50%	30%	10%	50%	30%	10%
ROOM INDEX	COEFFICIENT OF UTILISATION					
J	.16	.12	.11	.11	.09	.07
I	.20	.16	.14	.15	.12	.10
H	.23	.19	.17	.17	.14	.12
G	.27	.23	.19	.18	.16	.14
F	.30	.26	.22	.22	.18	.16
E	.34	.30	.26	.25	.21	.19
D	.37	.33	.30	.27	.24	.22
C	.40	.36	.33	.29	.26	.24
B	.45	.41	.37	.32	.29	.27
A	.47	.43	.40	.35	.31	.29



HOLOPHANE (R) INDIRECT UNIT
S5630-40

Curtis "Sno-Flake"

The "Sno-Flake" unit is highly efficient, economical to install, operate and maintain and is an excellent new lighting unit for school-rooms, offices, stores and other commercial interiors. The open pattern of the shallow die cast one piece aluminum louver completely shields the neck of the Silvered Bowl lamp at normal viewing angles. Maintenance costs are kept to a minimum as the unit does not harbour dust, insects, etc. The "Sno-Flake" is supplied complete with canopy, socket and an aluminum stem for 30" suspension. The stem may be cut to shorter lengths on the job if desired. A self-aligning fitting in the canopy permits the luminaire to hang plumb. Louver is finished in durable baked white enamel.

Holophane Indirect Luminaire

These units are ideal for the lighting of offices, classrooms and other locations where constant fine detail work is performed. Maximum eye comfort is provided by the absence of shadows and the low brightness of the luminaires. Prismatic action in the outer skirt bends the light out at wide angles over the ceiling without spots, streaks or shadows. Graceful contour and excellent fixture design give this unit broad architectural adaptability. The fixture has a typical stem suspension, with ball and socket aligner.

Catalogue No.	Lamp Watts* Silvered Bowl	Description	Dimensions	
			Overall Depth	Bowl Diameter
5200† 6065	300-500	"Sno-Flake" Unit Adapter for use with "Sno-Flake" Unit with 300W lamp.	32 ⁹ / ₁₆ "	18 ¹ / ₄ "
S-5640	500	Holophane Indirect Unit.	32 ⁹ / ₁₆ "	18 ¹ / ₄ "
S-5630	300	Holophane Indirect Unit	30 ³ / ₈ "	17 ¹ / ₂ "
			30 ³ / ₈ "	17 ¹ / ₂ "

*300W or 500W Mogul Base Silvered Bowl lamps.

†For very large rooms, or rooms with low ceilings, use a No. 6064 lamp neck shield. (R) The Holophane Co. Ltd.



SILVER BOWL DIRECT UNITS

Silvray "Skylike" Units

"SKYLIKE"

Louvered Incandescent
Lighting
Systems

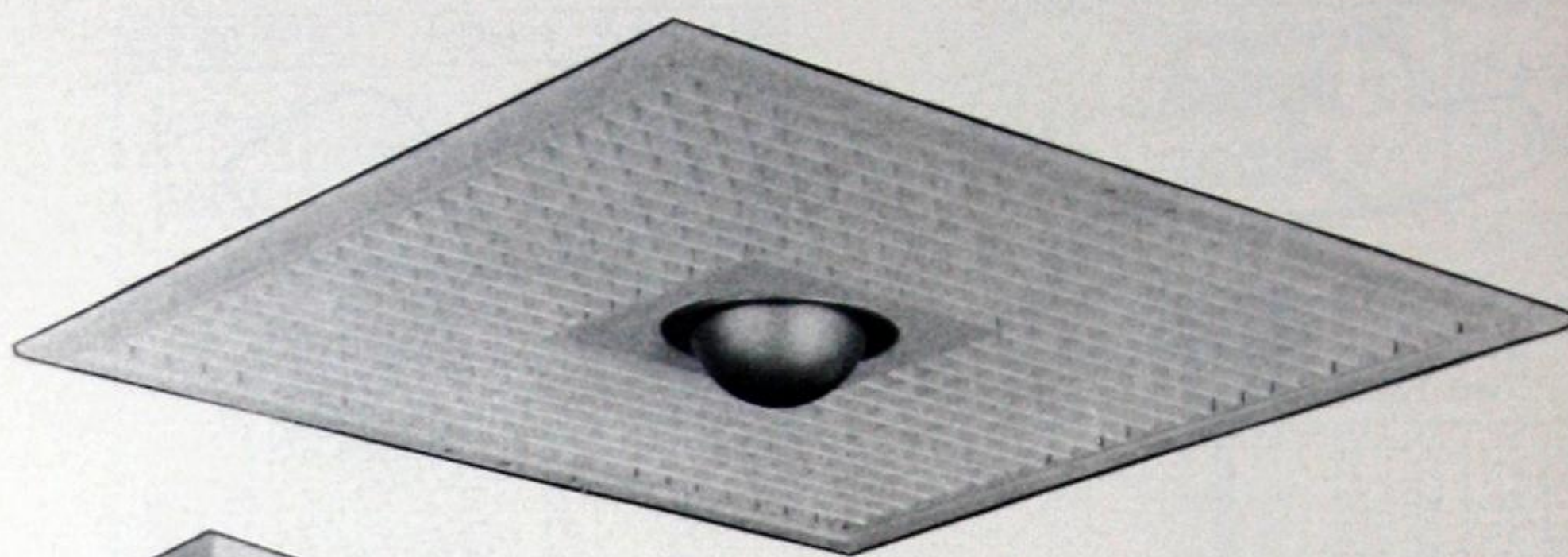

RECESSED

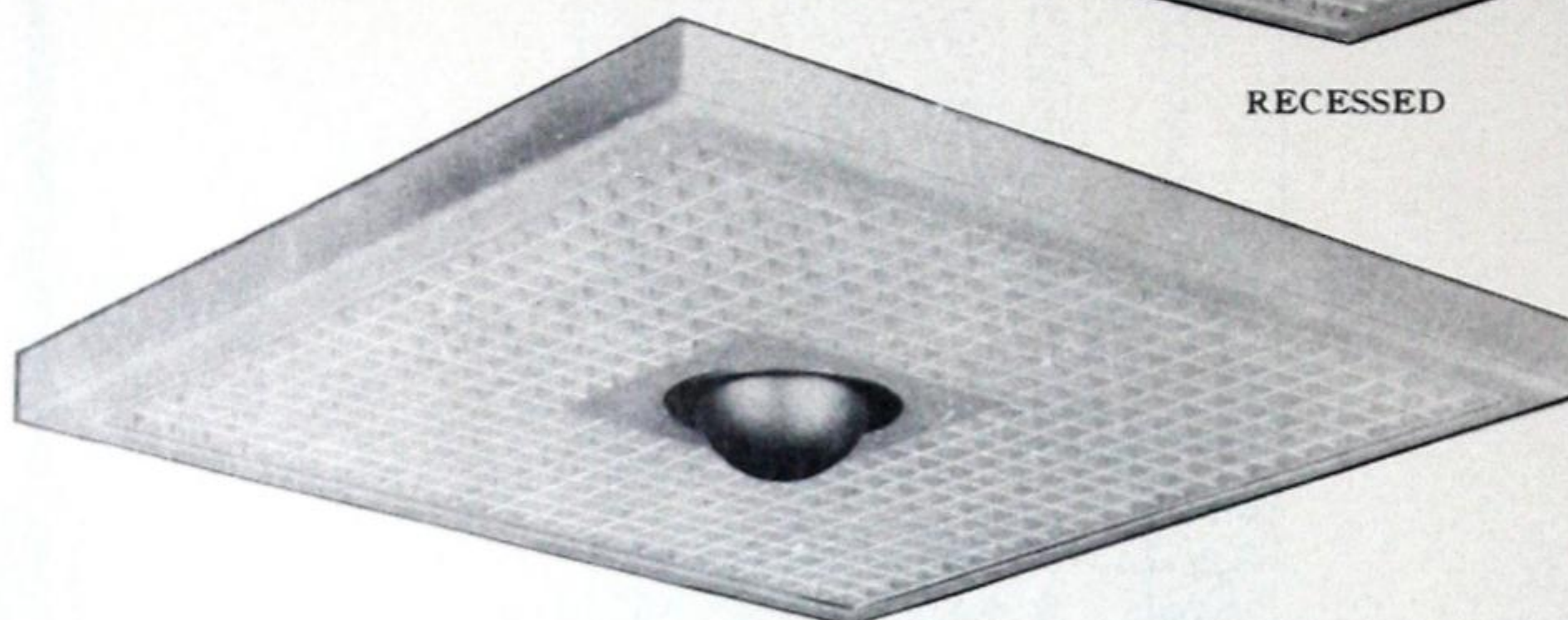

SEMI-RECESSED

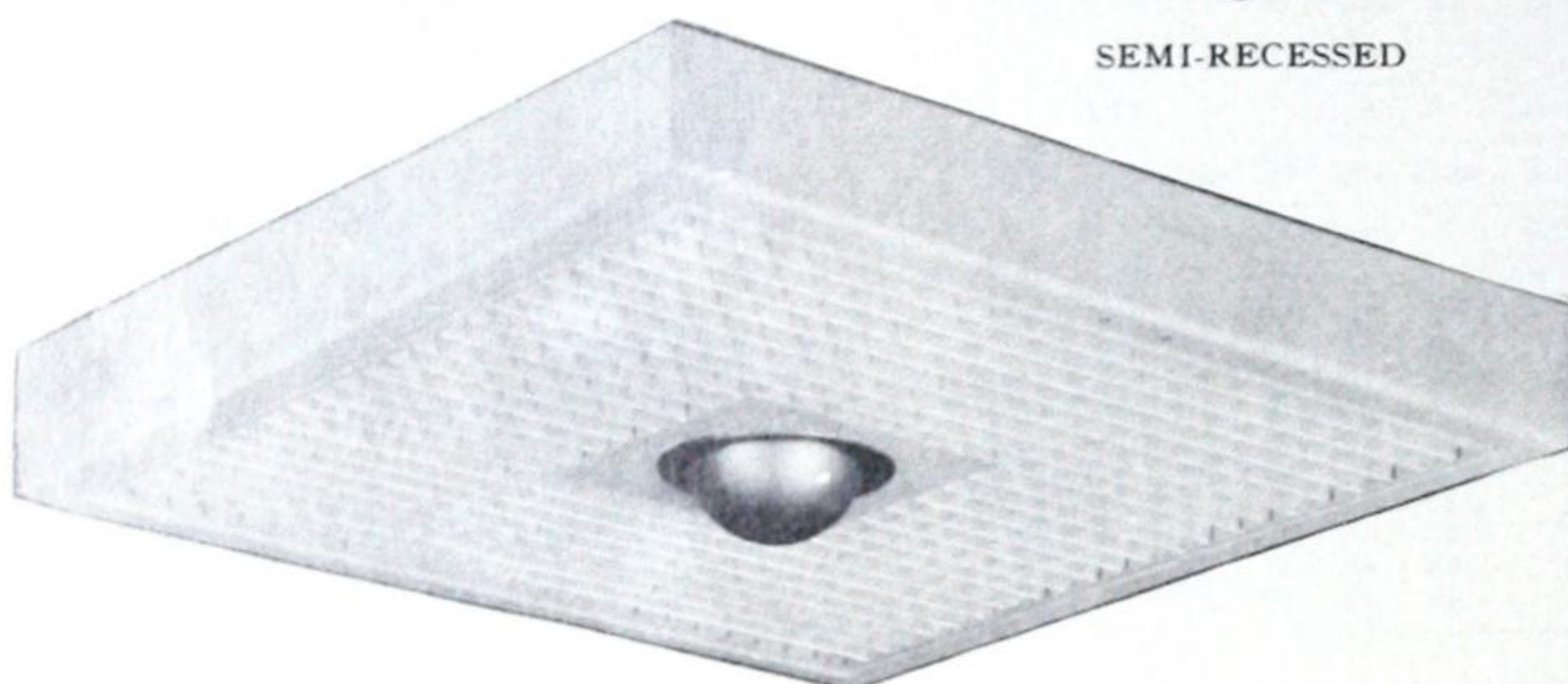

SURFACE MOUNTED

APPLICATIONS

The flexibility of the SKYLIKE system makes it eminently suitable to a wide variety of lighting applications. Whether the need be for carefully controlled brightness as in school or office, or for warm high level lighting as in retail stores.

Description

The Skylike System comprises a basic reflector and louver assembly and a group of accessories which are required to complete the basic unit or to adapt it to varying conditions of installation. By proper selection of basic unit and accessories, Skylike units can be used with 150, 200, 300 or 500 watt Silvered Bowl lamps. Similarly, they may be recessed, semi-recessed or surface mounted in or on ceilings of concrete, plaster, and metal or composition acoustical tile.

In both design and application, Skylike Systems are flexible and remarkably easy to install. Their simple modular design permits the architect or engineer to integrate them with building design in an infinite variety of patterns and arrangements.

Basic Units

The basic Skylike unit consists of a one piece die formed steel reflector and a hinged and removable metal louver. The reflector contour has been carefully designed to ensure maximum output of the light from Silvered Bowl lamps and the reflector and louver together have been arranged to eliminate any areas of high brightness which might be apparent from any viewing angle. The Silvered Bowl lamp extends through an opening in the center of the louver and may be relamped without disturbing either louver or reflector.

That portion of the reflector which is recessed is dimensioned to correspond to the usual sizes of ceiling acoustical material. It is slightly under 24" square and has an overall depth with receptacle assembly for medium base lamps of 7½"; with receptacle assembly for mogul base lamps of 8¾".

Reflectors are of two types: Catalogue No. 50F has a ¾" ceiling flange on all four sides and may be used for all methods of installation (i.e., recessed, semi-recessed, or surface mounted) in any kind of ceiling; Catalogue No. 50 has a very narrow flange and is used for recessed installation in acoustical ceiling constructions of the snap-in type.

Receptacle Assemblies

One of four receptacle assemblies is required to complete each basic Skylike unit. These assemblies are as follows: Cat. No. 51/150 for 150 watt lamps; Cat. No. 51/200 for 200 watt lamps; Cat. No. 51/300 for 300 watt mogul base lamps and Cat. No. 51/500 for 500 watt mogul base lamps. Each assembly includes an outlet box, a receptacle mounting plate or collar, a medium or mogul receptacle and a bulb ring. The last item is required to permit use of pole type lamp changer devices. The receptacle assemblies attach to the top of the reflector with bolts.

"Snap-In" Accessory

For hung acoustical ceilings of the "snap-in" type, two accessories are available to permit attachment of SKYLIKE units to the acoustical tile supporting member. These are Cat. No. 55F and No. 55, the former being used with base unit No. 50F and the latter with No. 50. Two are required for each unit and they are attached to the side of the reflector with bolts.



SILVER BOWL DIRECT UNITS

Silvray "Skylike" Units

Surface Mounted Installations

Skylike Systems are not limited to recessed installations. Units may be surface mounted singly or in multiple arrangements without any sacrifice in lighting quality. The surface mounting frame is available for this type of installation. Catalogue No. 53/200 is used for medium base assemblies and No. 53/500 for mogul base assemblies. To facilitate installations in plaster or concrete, frame mounting clips No. 53FM are available. The Skylike unit and receptacle assembly is attached to the frame with screws through the flange. The wide flange base unit No. 50F is used for surface mounted installations.

Semi-Recessed Installation

In some instances the amount of recess space above a hung ceiling will be limited by beams, pipes or ventilating ducts. Where this occurs the full depth of the Skylike reflector may not fit the space available and a semi-recessed installation may be necessary. The semi-recessed frame Cat. No. 54A is for use with acoustical ceilings and has a standard depth of 2"; No. 54P is for use on plaster ceilings and has a depth of 5". Both extend below the ceiling 2" but other depths are available on special order. Semi-recessed frames are used with No. 50F base units.

Plaster Frames

For preliminary framing of openings in plaster ceilings and to form a support for the reflector, Cat. No. 56 plaster frame is available.

How To Determine "Skylike" Requirements

Step I—Determine Light Distribution Desired

Use No. 50 or 50F units with Silvered Bowl lamps:

- Where low brightness is desired as in schools, offices, libraries, drafting room.
- Where ceilings are of average height—up to 14'.
- Wherever good diffusion and soft shadows are desired.

Step II—Select Lamp Size (see also Steps IV and V)

- Use 150 or 200W Silvered Bowl lamps for school and office.
- Use 200, 300 or 500W Silvered Bowl lamps for merchandising areas, lobbies, gymnasiums and similar high ceiling areas.

Step III—Determine Total Lumens needed for Desired Foot Candle Level

- Obtain room index.
- Determine coefficient of utilization—see below.
- Obtain total lumens from formula—

$$\text{LUMENS} = \frac{\text{Area} \times \text{footcandles}}{\text{Coefficient of utilization} \times \text{maintenance factor}}$$

(Maintenance factors. (MF)—see below.)

Step IV—Determine Number of Lamps and Skylike Units

Divide total lumens by lamp lumens of lamp size selected.

(Lumen Ratings: 150W SB=2450; 200W SB=3450; 300W SB=5350; 500W SB=9400.)

Where there is a choice as to lamp size, determine number of lamps and units for both lamp sizes and make final decision after comparison of scale layouts (Step V).

Step V—Make Scale Layout of Area

Arrange units for uniform coverage. In general the center to center distance of Skylike units or multiple unit patterns should not exceed the distance from floor to ceiling. They can be as close together as good appearance and construction will permit. Select the layout which provides most uniform coverage and provides a pleasing balance between ceiling and lighting element.

Step VI—Determine Type of Installation

- Recessed, semi-recessed or exposed.
- If recessed, determine type of ceiling, i.e., plaster, acoustical, composition, etc., and type of framing.

SPACING 1xMH		EFF 61.0%					
M.F.	"SKYLIKE"	0% ↑					
G.75		61.0% ↓					
M.70							
P.65							
CEILING	75%			50%			
WALLS	50%	30%	10%	50%	30%	10%	
ROOM INDEX	COEFFICIENT OF UTILISATION						
J	.30	.28	.26	.30	.28	.26	
I	.37	.34	.33	.36	.33	.33	
H	.40	.38	.37	.39	.37	.36	
G	.43	.41	.40	.42	.40	.39	
F	.45	.43	.41	.43	.41	.41	
E	.47	.46	.44	.46	.44	.44	
D	.50	.48	.47	.49	.48	.46	
C	.52	.50	.48	.50	.49	.48	
B	.53	.51	.50	.52	.50	.49	
A	.54	.52	.51	.53	.51	.50	

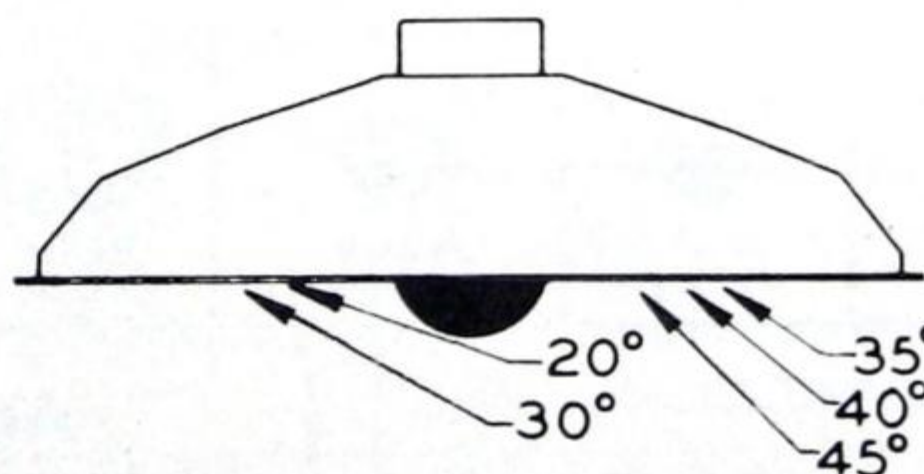

Luminaire Brightness

Position	20°	30°	35°	40°	45°
200W. Silvered Bowl Lamp	1.1	1.6	2.4	3.2	4.0
Candles per square inch					



SILVER BOWL DIRECT UNITS

Silvray "Skylike" Units

Step VII—Determine Parts Required

(Refer to selection chart below.)

- a. Select proper BASE UNIT—No. 50F with flange or No. 50 less flange.
- b. Select proper RECEPTACLE ASSEMBLY—No. 51/150 for 150W lamps; No. 51/200 for 200W; No. 51/300 for 300W; No. 51/500 for 500W.
- c. If installation is surface mounted, add SURFACE MOUNTING FRAME No. 53/200 for 150 or 200W lamps; No. 53/300 for 300 or 500W lamps.
- d. If installation is semi-recessed add SEMI-RECESSED FRAME No. 54A or 54P. If standard SEMI-RECESSED FRAME is not adequate, determine depth required and specify on order.
- e. If recessed installation in plaster ceiling, add PLASTER FRAME No. 56.
- f. If recessed installation in acoustical ceilings use No. 55F or No. 55 "SNAP-IN" ACCESSORY—2 required per unit.

Base Units

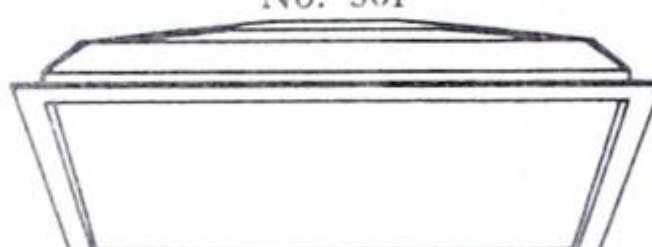
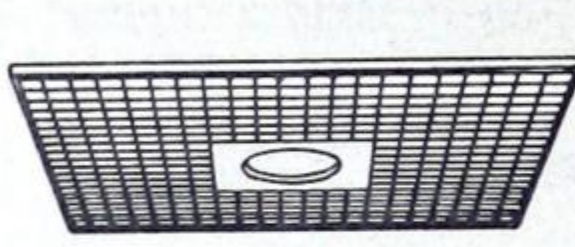
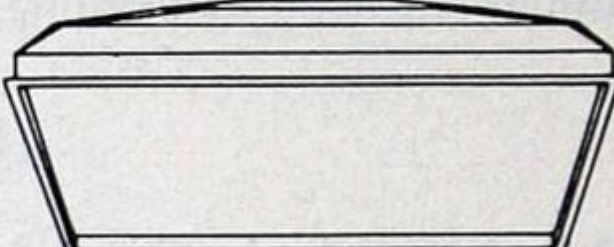
 <p>No. 50F</p> <p>*RECESSED SINGLE UNITS ALL CEILINGS</p>	 <p>SUPPLIED WITH EACH BASE UNIT</p>	 <p>No. 50</p> <p>RECESSED MULTIPLE UNITS ALL CEILINGS</p>
<p>*Use for surface mounted or semi-recessed installations with appropriate mounting frame.</p>		



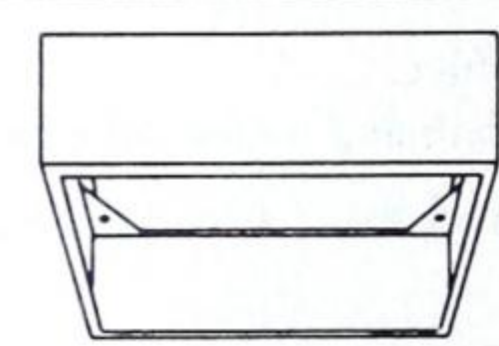



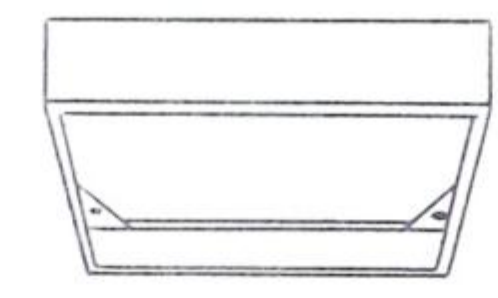
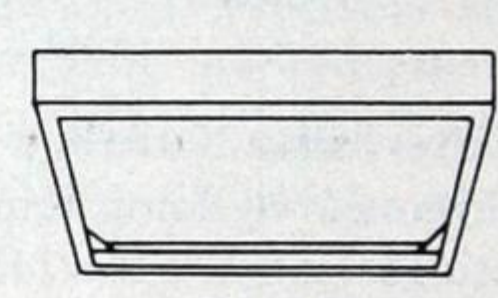











Surface Mounting Frames

<p>Cat. No. 53/300 use with base unit No. 50F for surface mounted installations, 300-500W.</p>		<p>Cat. No. 53/200 use with base unit No. 50F for surface mounted installations, 150-200W.</p>
--	---	--



Semi-Recessed Mounting Frames

 <p>No. 54P</p>	<p>Cat. No. 54P use with base unit No. 50F for semi-recessed installation in plaster ceilings.</p> <p>Cat. No. 54A use with base unit No. 50F for semi-recessed installations in acoustical ceilings.</p>	 <p>No. 54A</p>
--	---	--

Receptacle Assemblies

Cat. No. 51/150 medium base for 150W lamp.					Cat. No. 51/200 medium base for 200W lamp.				
 OUTLET BOX	 MOUNTING PLATE	 SOCKET	 EXTENSION	 BULB RING	 OUTLET BOX	 MOUNTING PLATE	 SOCKET	 BULB RING	
Cat. No. 51/300 Mogul base for 300W lamp.					Cat. No. 51/500 Mogul base for 500W lamp.				
 OUTLET BOX	 SOCKET COLLAR	 SOCKET	 NECK SHIELD	 BULB RING	 OUTLET BOX	 SOCKET COLLAR	 SOCKET	 NECK SHIELD	 BULB RING

Accessories

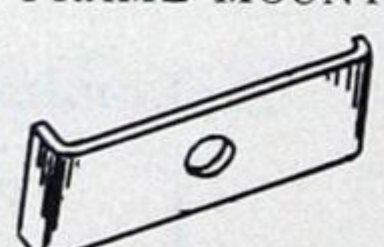
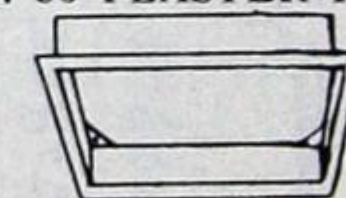
<p>No. 55 SNAP-IN-STRIP</p>  <p>FOR BASE UNIT No. 50 IN ACOUSTICAL CEILING</p>	<p>No. 55F SNAP-IN-STRIP</p>  <p>FOR BASE UNIT No. 50F IN ACOUSTICAL CEILING</p>	<p>No. 53FM FRAME MOUNTING CLIP</p>  <p>TO SECURE SURFACE MOUNTING FRAME TO PLASTER CEILING</p>	<p>No. 56 PLASTER FRAME</p>  <p>FOR RECESSED OR SEMI-RECESSED INSTALLATIONS IN PLASTER CEILINGS. FOR SEMI-RECESSED USE WITH No. 54A.</p>
---	---	--	---



SILVER BOWL DIRECT UNITS

Silvray "Skylike" Units

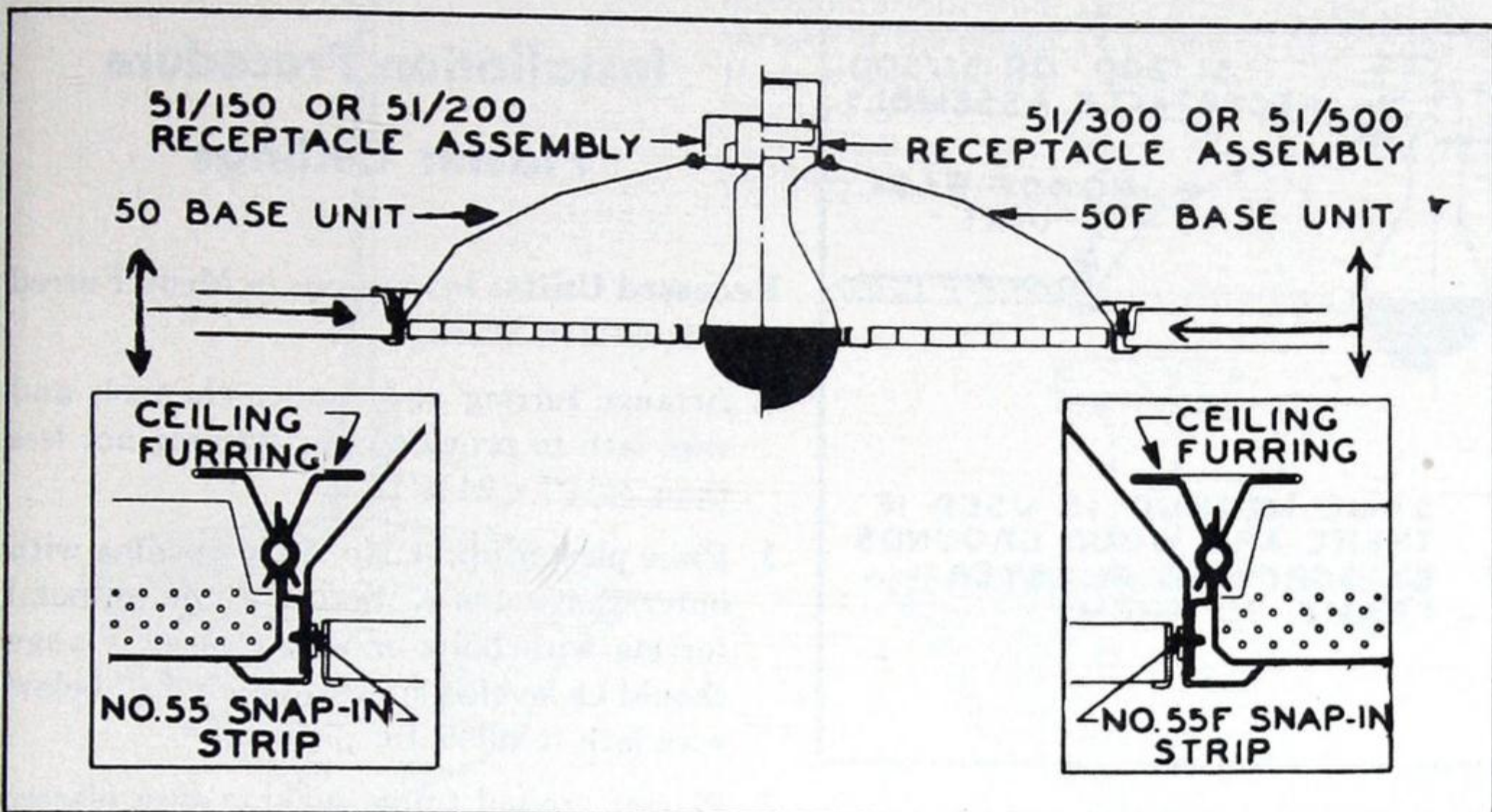

RECESSED UNIT

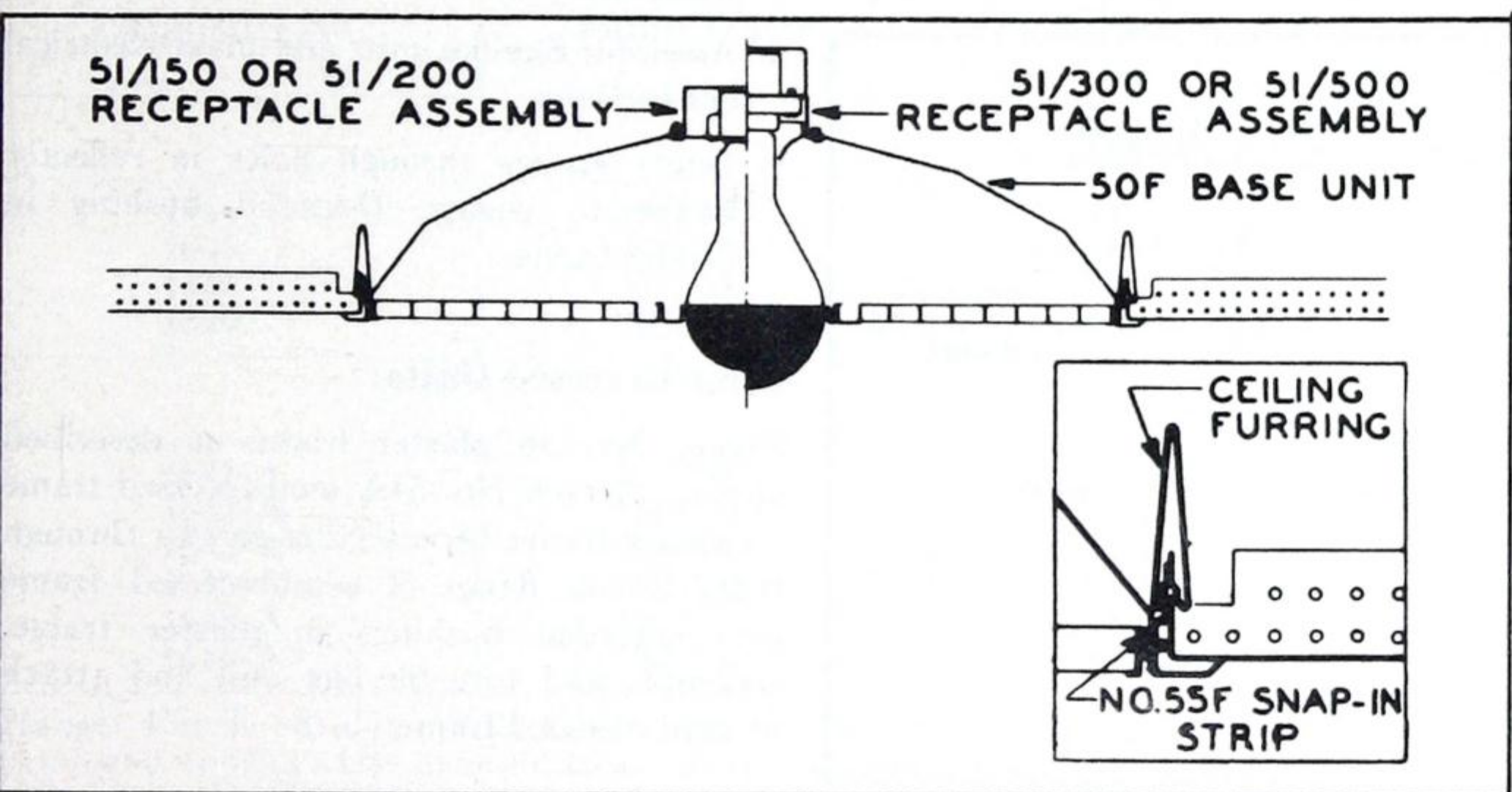

RECESSED UNIT

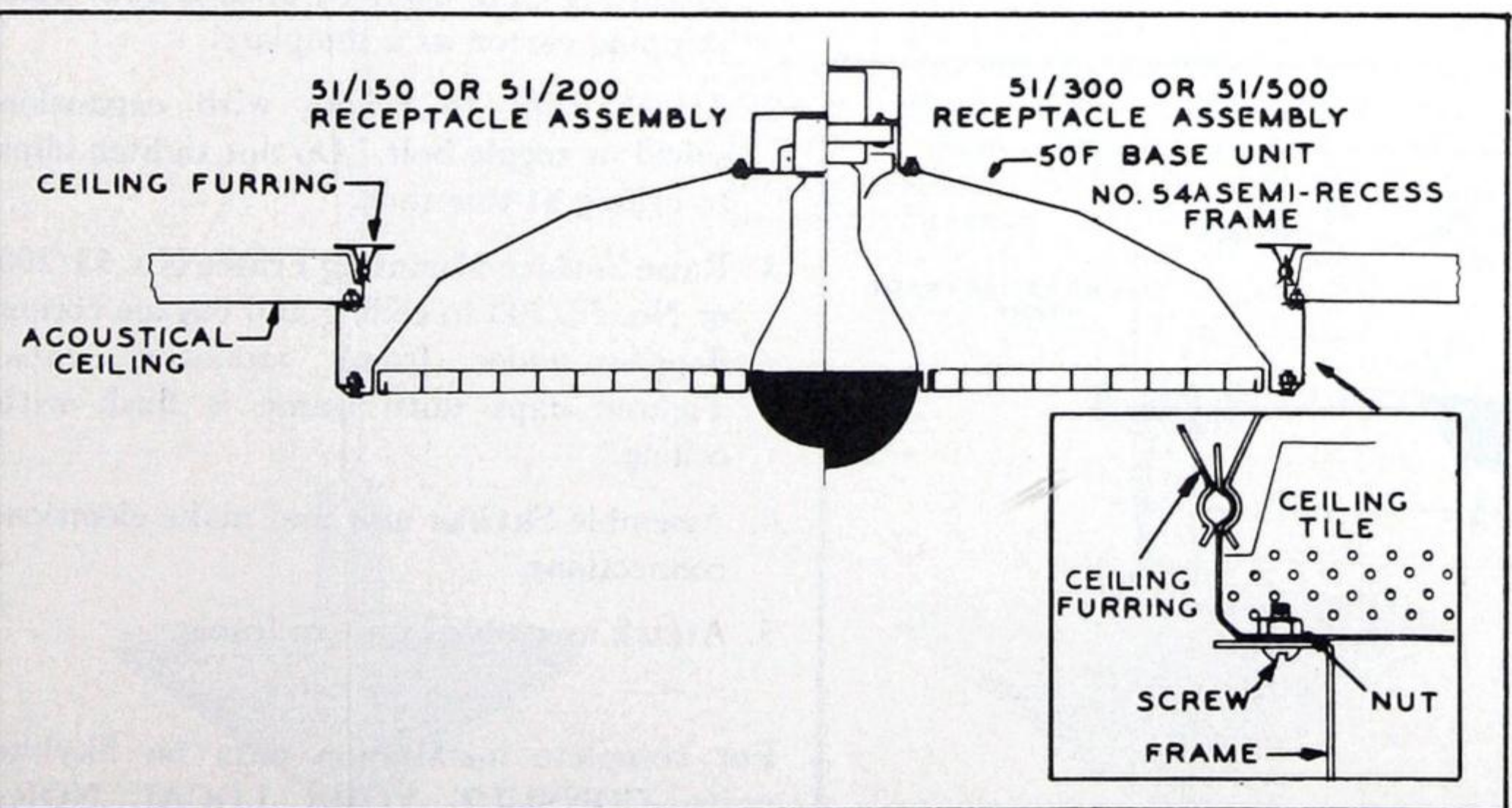

SEMI-RECESSED UNIT

Installation Procedure Acoustical Ceilings

Recessed Units

1. Provide 24" x 24" opening by removing acoustical tile.
2. Attach "Snap-in" Accessory No. 55F (with Base Unit No. 50F) or No. 55 (with Base Unit No. 50) to reflector on two opposite sides of reflector.
3. Assemble reflector and Receptacle Assembly and make electrical connections.
4. Push unit into ceiling opening and engage "Snap-in" Accessory in the runners which hold the acoustical tile. Units are properly engaged on No. 50F reflectors when flange is tight against surface of tile; on No. 50 when flange is level with surface of tile.

Semi-Recessed Units:

1. Attach No. 54A Semi-Recessed Frame to acoustical tile using nut and bolt or sheet metal screw at each corner.
2. Assemble Skylike unit and make electrical connections.
3. Attach assembled unit to Semi-Recessed Frame.

Surface Mounted Units:

Follow procedure for semi-recessed units in acoustical ceilings, except use No. 53/200 or No. 53/300 Surface Mounting Frame instead of No. 54A Semi-Recessed Frame.

The overall height of surface mounted Skylike units for medium base lamps is 7 $\frac{3}{4}$ " and for mogul base lamps is 9". These dimensions result in good proportions particularly where units are installed in multiple unit patterns of 2, 3, 5, or more units. Note, however, that height can be reduced in each instance by 1 $\frac{3}{4}$ " if (a) reflectors can be attached directly to existing flush outlet boxes, eliminating Skylike outlet box; or (b) if a sufficient portion of the ceiling can be cut away to permit the Skylike box to be recessed.

SILVER BOWL DIRECT UNITS

Silvray "Skylike" Units

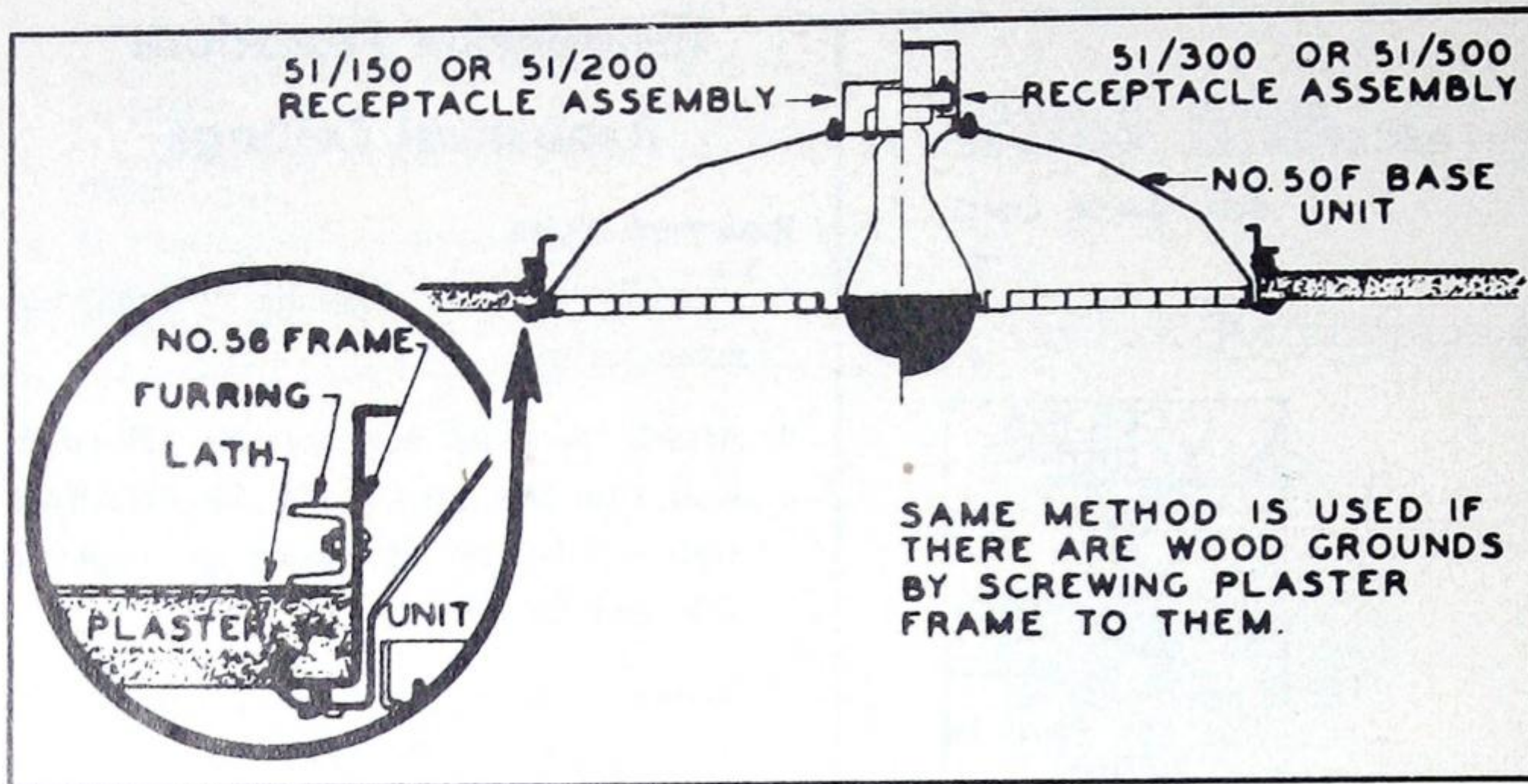

RECESSED UNIT

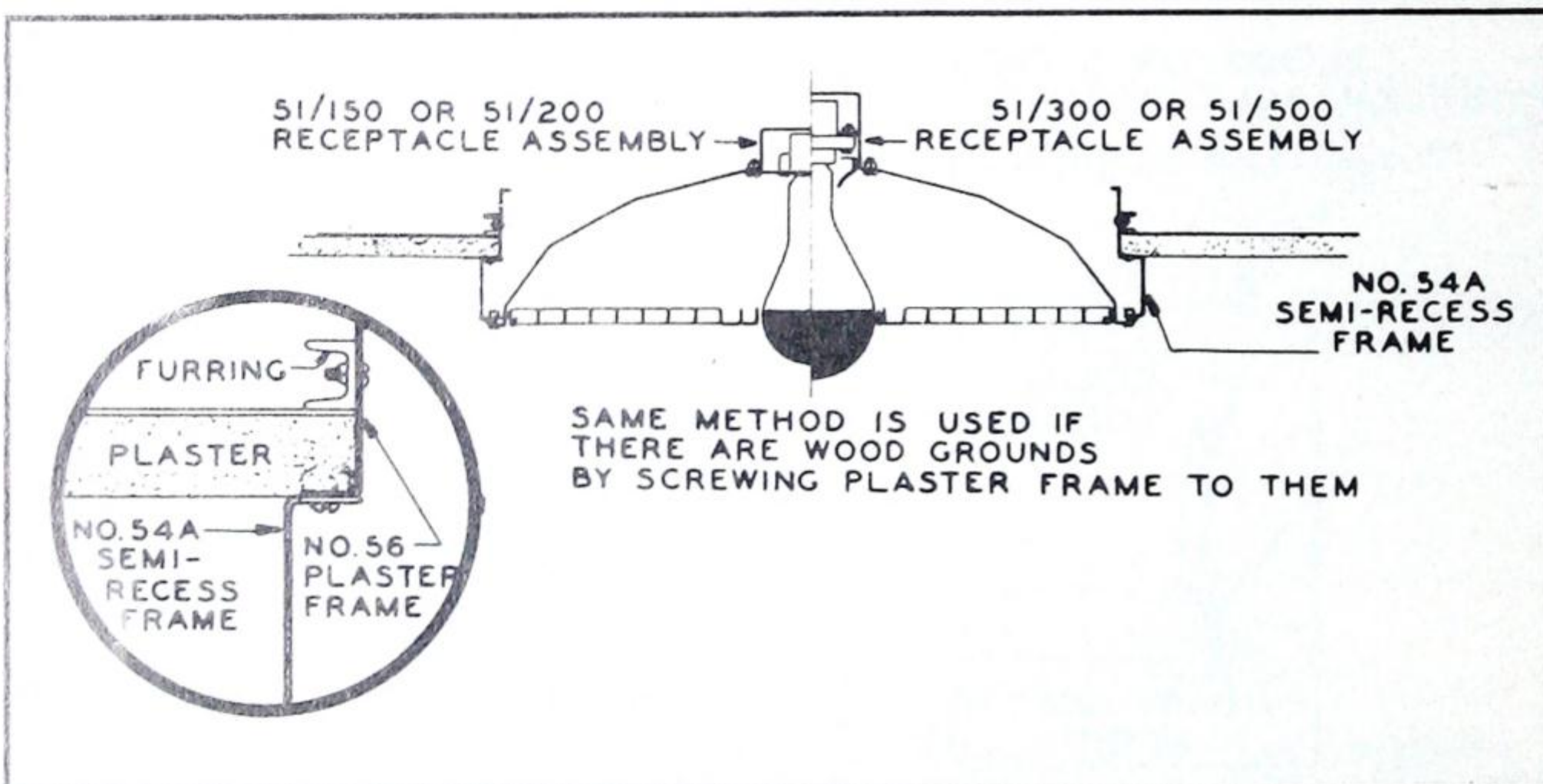

SEMI-RECESSED UNIT

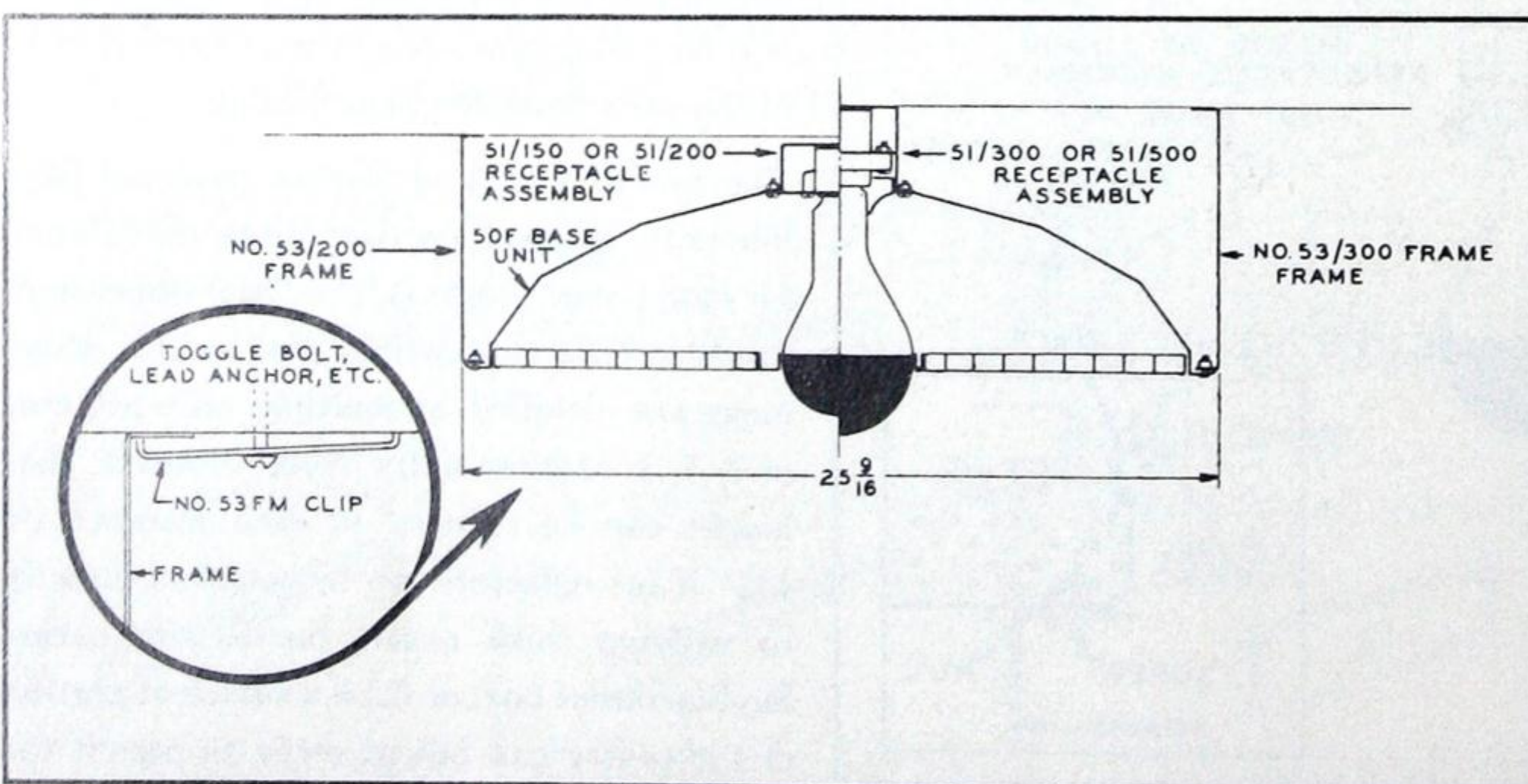

SURFACE MOUNTED UNIT

Installation Procedure
Plaster Ceilings

Recessed Units: Installtions in Metal Furred Ceilings—New Work.

1. Arrange furring and runner channels and wire lath to provide clear opening not less than $24\frac{1}{4}''$ x $24\frac{1}{4}''$.
2. Place plaster frame No. 56 in opening with outer flange down. Secure frame to metal furring with bolts or wire clasps. Flange should be leveled approximately $\frac{3}{4}''$ below wire lath to allow for plaster.
3. Plaster around frame making sure plaster is well troweled over flange of frame.
4. Remove 8 small knockouts in flange of reflector.
5. Assemble Skylike units and make electrical connections.
6. Insert screws through holes in reflector flange to engage threaded bushing in plaster frame.

Semi-Recessed Units:

Install No. 56 plaster frame as described above. Attach No. 54A semi-recessed frame to plaster frame by inserting screws through holes in top flange of semi-recessed frame into threaded bushings in plaster frame. Assemble and wire Skylike unit and attach to semi-recessed frame.

Surface Mounted Units:

1. Locate position for No. 53 FM Frame-Mounting Clip, using cardboard liner from shipping carton as a template.
2. Attach clips to ceiling with expansion shield or toggle bolt. Do not tighten clips to ceiling at this time.
3. Raise Surface Mounting Frame No. 53/200 or No. 53/300 to ceiling and engage corner flanges under frame mounting clips. Tighten clips until frame is flush with ceiling.
4. Assemble Skylike unit and make electrical connections.
5. Attach assembled unit to frame.

For complete installation data on Skylike units—CONSULT YOUR LOCAL NORTHERN ELECTRIC OFFICE.



SEMI-INDIRECT UNITS

The Midas Unit

Midas Units are indirect fixtures with translucent plastic bowl which is guaranteed against warping, discoloration, and absorption of moisture. The surface of the plastic bowl has no dark rings or spots to mar its uniform illumination, and the surface brightness is such as to allow the fixture to blend harmoniously with the ceiling. Available with pendent, or close-to-ceiling hangers.

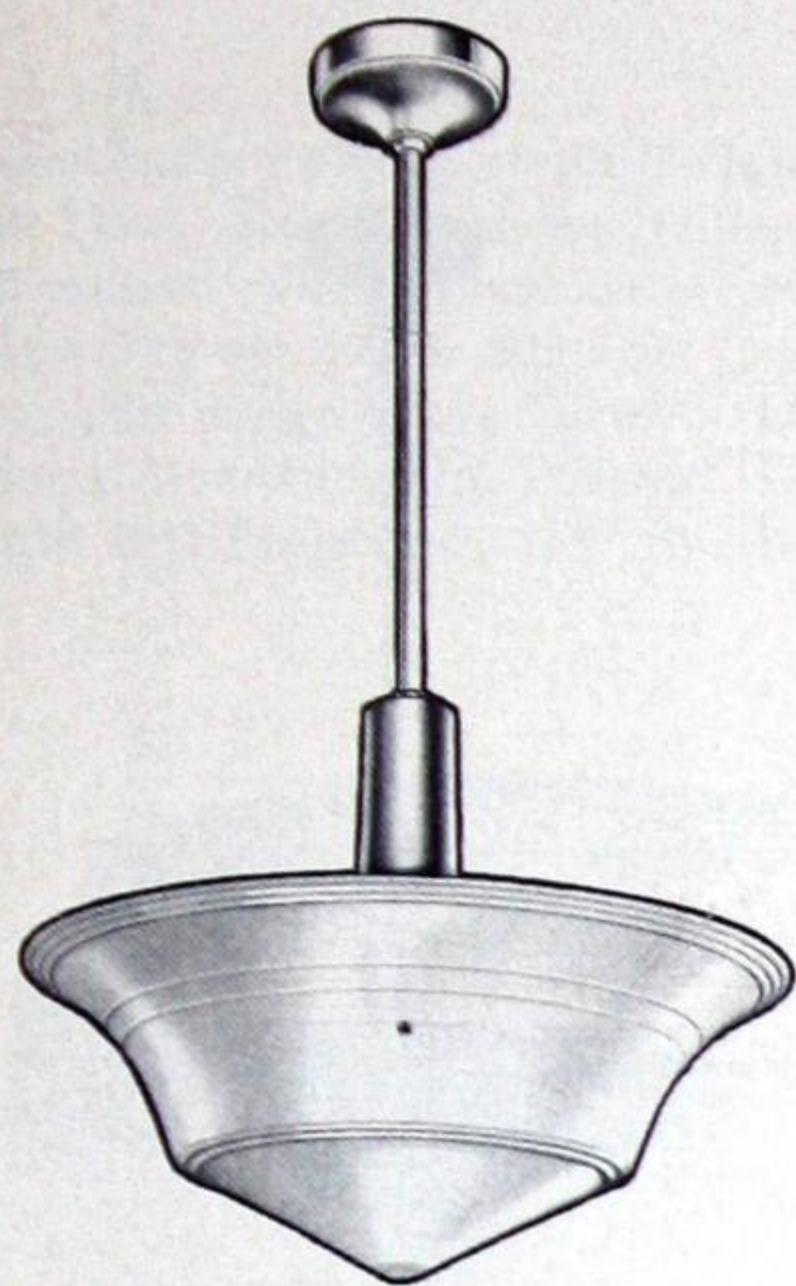

No. 1546

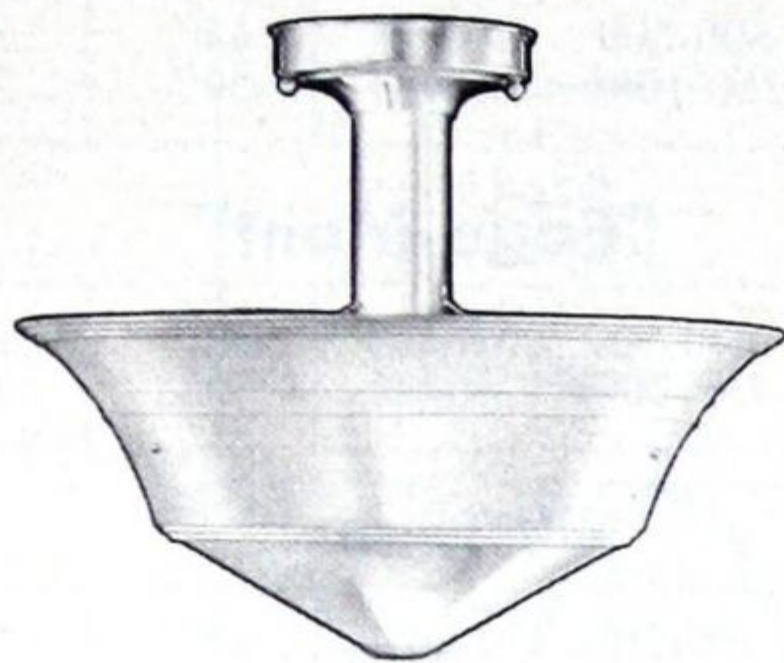

No. 1544

SPACING 1.2xCH		EFF 87.0%				
M.F.	"MIDAS"	74% ↑				
G.65		13% ↓				
M.60						
P.50						
CEILING	75%	50%				
WALLS	50%	30%	10%	50%	30%	10%
ROOM INDEX	COEFFICIENT OF UTILISATION					
J	.18	.14	.13	.13	.11	.09
I	.23	.19	.17	.17	.14	.12
H	.26	.22	.20	.19	.16	.14
G	.30	.25	.22	.21	.19	.17
F	.32	.28	.25	.24	.21	.19
E	.36	.32	.29	.27	.23	.21
D	.40	.35	.32	.29	.26	.24
C	.42	.38	.35	.30	.28	.26
B	.46	.42	.40	.33	.31	.29
A	.48	.44	.42	.35	.32	.31

Catalogue No.	Lamp Watts	Socket Type	Dimensions	
			Overall Length	Bowl Diameter
"Midas"				
1544	200/250	Medium	14 1/2"	16"
1546	200/250	Medium	28"	16"
1547	60/100	Medium	11 3/8"	10 1/2"
1549	300/500	Mogul	33 1/2"	19"
"Magna"				
1641-A	60/100	Medium	24"	14 3/8"
1642-A	150/200	Medium	29"	16 3/8"
1643-A	300/500	Mogul	36"	18 3/8"
1644-A	750/1500	Mogul	50"	22 3/8"
1645-A	150/200	Medium	14 1/2"	16 3/8"
1646-A	100/150	Medium	11 3/4"	14 3/8"

Hanger Finish—Midas—Satin Silver. Magna—Satin Aluminum, also available in brushed chrome. To order delete suffix "A" from catalogue number. Use medium base socket extension with 150 W lamps.

Ainsworth Magna Unit

The Magna semi-indirect unit employs a special luminous glass bowl which blends with the ceiling and offers no contrasting surfaces that would produce eye strain. These units produce a soft, mellow quality of light ideal for highest visibility, with minimum glare. Available with pendent, or close-to-ceiling hangers.

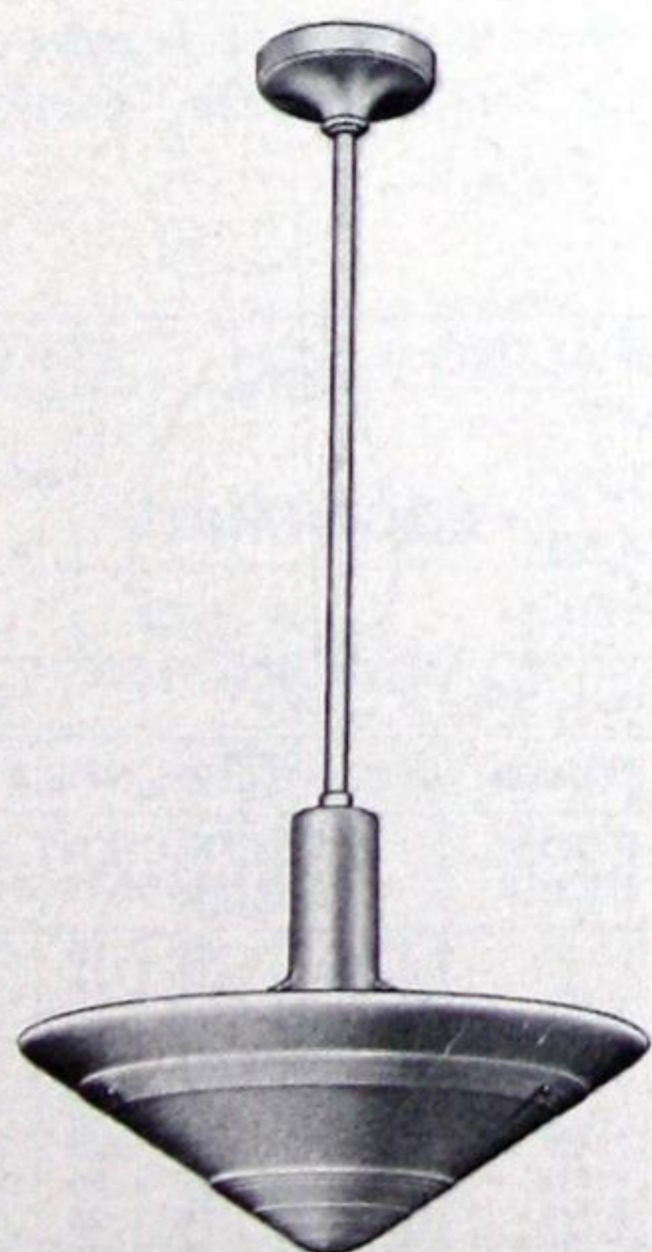

No. 1641A

1644A



No. 1645A-46A

SPACING 1.2xCH		EFF 82.5%				
M.F.	"MAGNA"	80.5% ↑				
G.65		2.0% ↓				
M.60						
P.50						
CEILING	75%	50%				
WALLS	50%	30%	10%	50%	30%	10%
ROOM INDEX	COEFFICIENT OF UTILISATION					
J	.18	.14	.13	.13	.11	.09
I	.23	.19	.17	.17	.14	.12
H	.26	.22	.20	.19	.16	.14
G	.30	.25	.22	.21	.19	.17
F	.32	.28	.25	.24	.21	.19
E	.36	.32	.29	.27	.23	.21
D	.40	.35	.32	.29	.25	.24
C	.42	.38	.35	.30	.28	.26
B	.46	.42	.40	.33	.31	.29
A	.48	.44	.42	.35	.32	.31



INDIRECT UNITS
Curtis Indirect Units

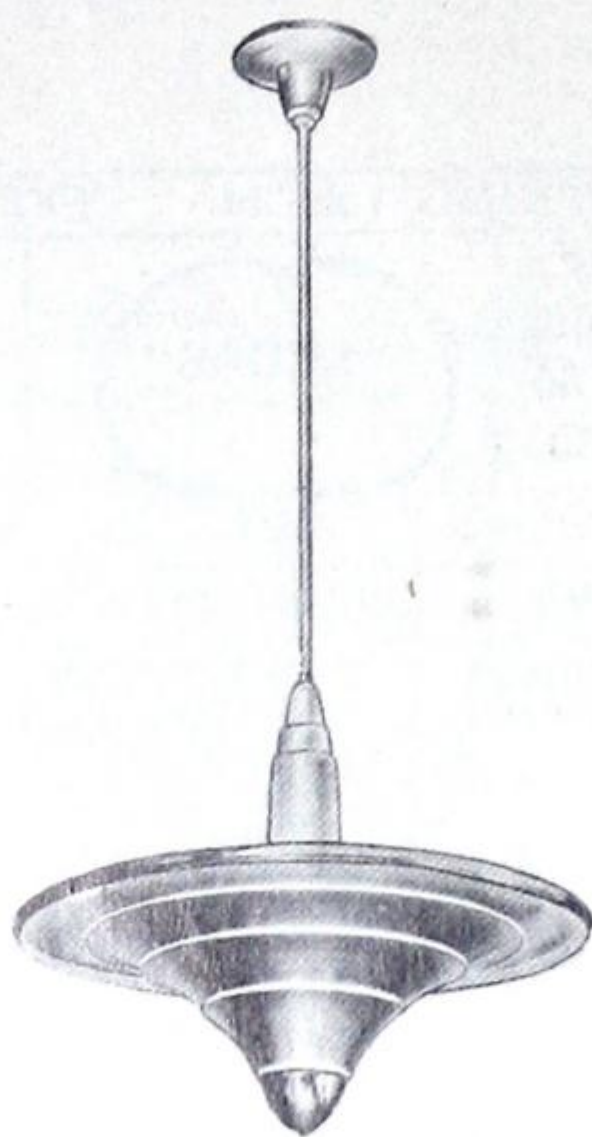

No. 1250
"EDGE-RAY"

Cat. No.	Lamp Watts	Socket Type	Dimensions	
			Overall Length	Bowl Diameter
"Edge-Ray"				
1250	300-500	Mogul	44"	21 ³ / ₈ "
1270	750-1000	Mogul	59"	27 ¹ / ₂ "
"Edge-Mont"				
1260	300-500	Mogul	44"	21 ³ / ₈ "
1280	750-1000	Mogul	58 ¹ / ₄ "	27 ¹ / ₂ "
"Winner"				
5090	300-500	Mogul	43"	19 ¹ / ₂ "

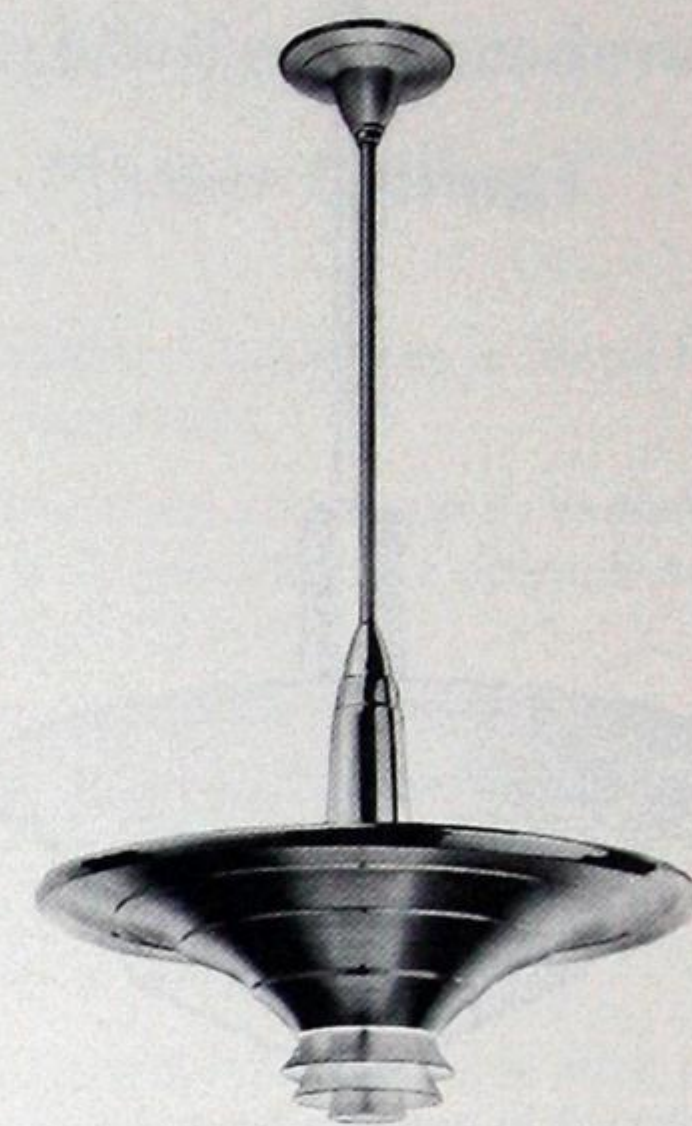

No. 1260
"EDGE-MONT"

"Edge-Ray" and "Edge-Mont"

The unusual beauty of "Edge-Ray" Luminaires is best appreciated by actually seeing them lighted. A special reflector ring at the top of the bowl redirects a small portion of the light downward on to the bowl itself and the graining of the bowl and the concentric vertical bands pick up this light. Viewed from below, the indirect "Edge-Ray" luminaires effect an interesting array of softly lighted circles. "Edge-Ray" luminaires shown here may be used harmoniously and intelligently in the same interior for various types of lighting and locations, or an entire room may be lighted with a single type. Made of Aluminum. Equipped with silvered glass reflector.

The "Edge-Mont" is the "Edge-Ray" style luminaire for direct-indirect lighting. Concentric-ring, staggered steel louvers are centered in the bottom of the bowl. These louvers (painted mat grey) control the strong "plus" light which is directed downward on the feature area.

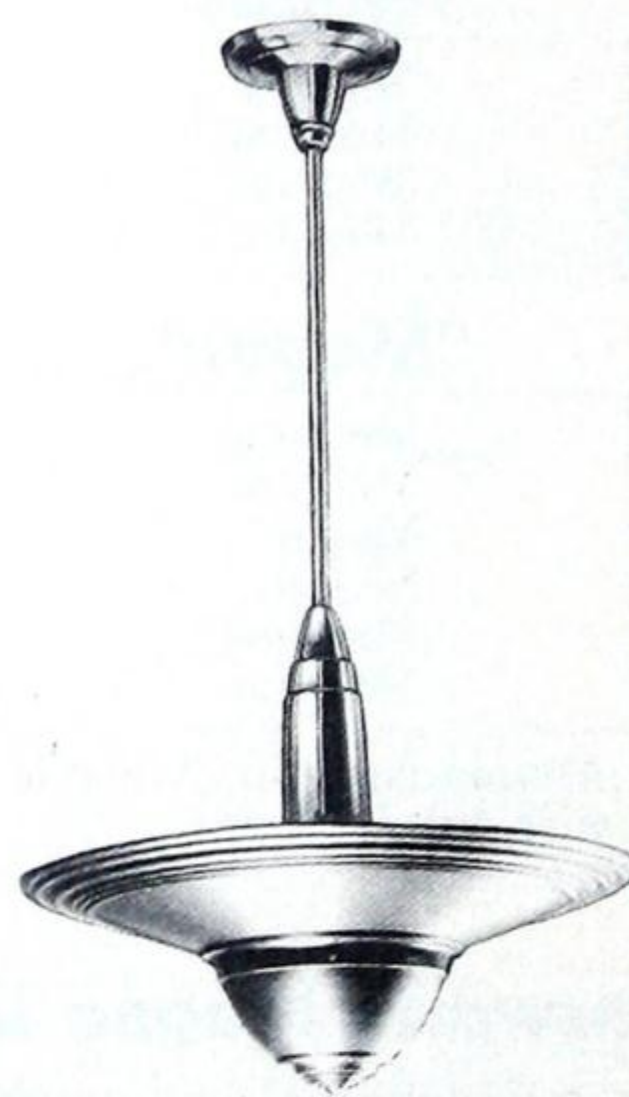

No. 5090
"WINNER"

"Winner"

This is a totally indirect luminaire embodying simplicity and trimness in style with maximum lighting efficiency. Recommended for those interiors where close eye-work is performed—offices, schools, drafting rooms.

The Winner is a Curtis "Eye-Comfort" Luminaire with concealed silvered glass reflector, producing a high intensity of glareless light that is evenly distributed throughout the room.

With no bright spots and almost shadowless lighting, "Eye-Comfort" Luminaires provide the type of illumination that is easy on the eyes ensuring fast, accurate, comfortable work.

SPACING 1xCH		EFF 57.5%				
M.F.	"EDGE-RAY"	56.5% ↑				
G.65		1.0% ↓				
M.55						
P.40						
CEILING	75%		50%			
WALLS	50%	30%	10%	50%	30%	10%
ROOM INDEX	COEFFICIENT OF UTILISATION					
J	.12	.09	.08	.08	.06	.05
I	.14	.12	.10	.10	.08	.07
H	.17	.14	.12	.11	.09	.08
G	.19	.16	.14	.13	.11	.10
F	.21	.18	.16	.15	.12	.11
E	.24	.21	.19	.16	.14	.13
D	.26	.23	.21	.17	.16	.15
C	.28	.25	.23	.19	.17	.16
B	.31	.27	.26	.20	.19	.18
A	.32	.30	.28	.22	.20	.19

SPACING 1xCH		EFF 57.5%				
M.F.	"WINNER"	56.5% ↑				
G.65		1.0% ↓				
M.55						
P.40						
CEILING	75%		50%			
WALLS	50%	30%	10%	50%	30%	10%
ROOM INDEX	COEFFICIENT OF UTILISATION					
J	.12	.09	.08	.08	.06	.05
I	.14	.12	.10	.10	.08	.07
H	.17	.14	.12	.11	.09	.08
G	.19	.16	.14	.13	.11	.10
F	.21	.18	.16	.15	.12	.11
E	.24	.21	.19	.16	.14	.13
D	.26	.23	.21	.17	.16	.15
C	.28	.25	.23	.19	.17	.16
B	.31	.27	.26	.20	.19	.18
A	.32	.30	.28	.22	.20	.19

SPACING 1.2xCH		EFF 65.0%				
M.F.	"EDGE-MONT"	57.2% ↑				
G.70		7.8% ↓				
M.60						
P.50						
CEILING	75%		50%			
WALLS	50%	30%	10%	50%	30%	10%
ROOM INDEX	COEFFICIENT OF UTILISATION					
J	.15	.13	.12	.12	.11	.09
I	.19	.16	.15	.15	.13	.12
H	.21	.19	.17	.17	.15	.14
G	.24	.22	.19	.19	.17	.16
F	.26	.23	.21	.20	.18	.17
E	.28	.26	.24	.23	.20	.19
D	.31	.29	.27	.24	.22	.21
C	.33	.31	.29	.25	.23	.22
B	.36	.34	.32	.27	.25	.25
A	.37	.35	.33	.29	.27	.26



INDIRECT UNIT

Curtis Wall Urns and Reflectors

"Urna"

Modestly sized offices, stores, restaurants—are briefly suggestive of those interiors which lend themselves to illumination from Curtis Wall Urns. Rooms with low ceilings may be flooded with generous indirect lighting from several of these units mounted on existing wall outlets. This application involves little installation cost and provides a thoroughly modern lighting result. Curtis Wall Urns are designed to use 300 or 500 watt lamps, and give most even distribution. A silvered glass reflector (EC-69) is employed as an integral part of the design of the "Urna". The body of the unit which is the silvered glass reflector is finished in Bronze, the support is finished in Satin Aluminum with Polished Highlights. "Urna" bespeaks high quality in lighting efficiency and fabrication. Overall Dimensions: Height 14", Projection 13½", Width 13".



No. 1548

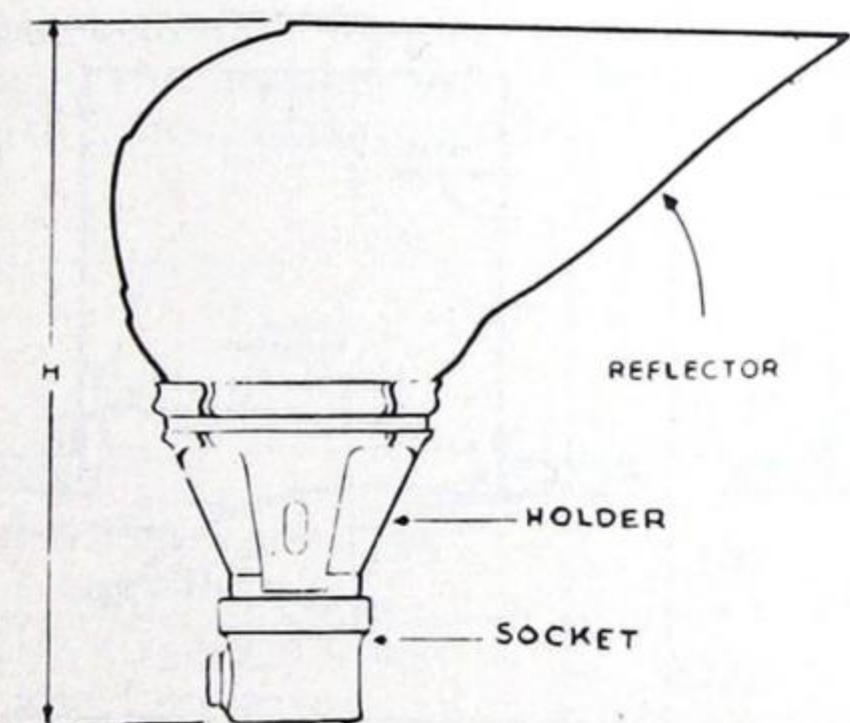
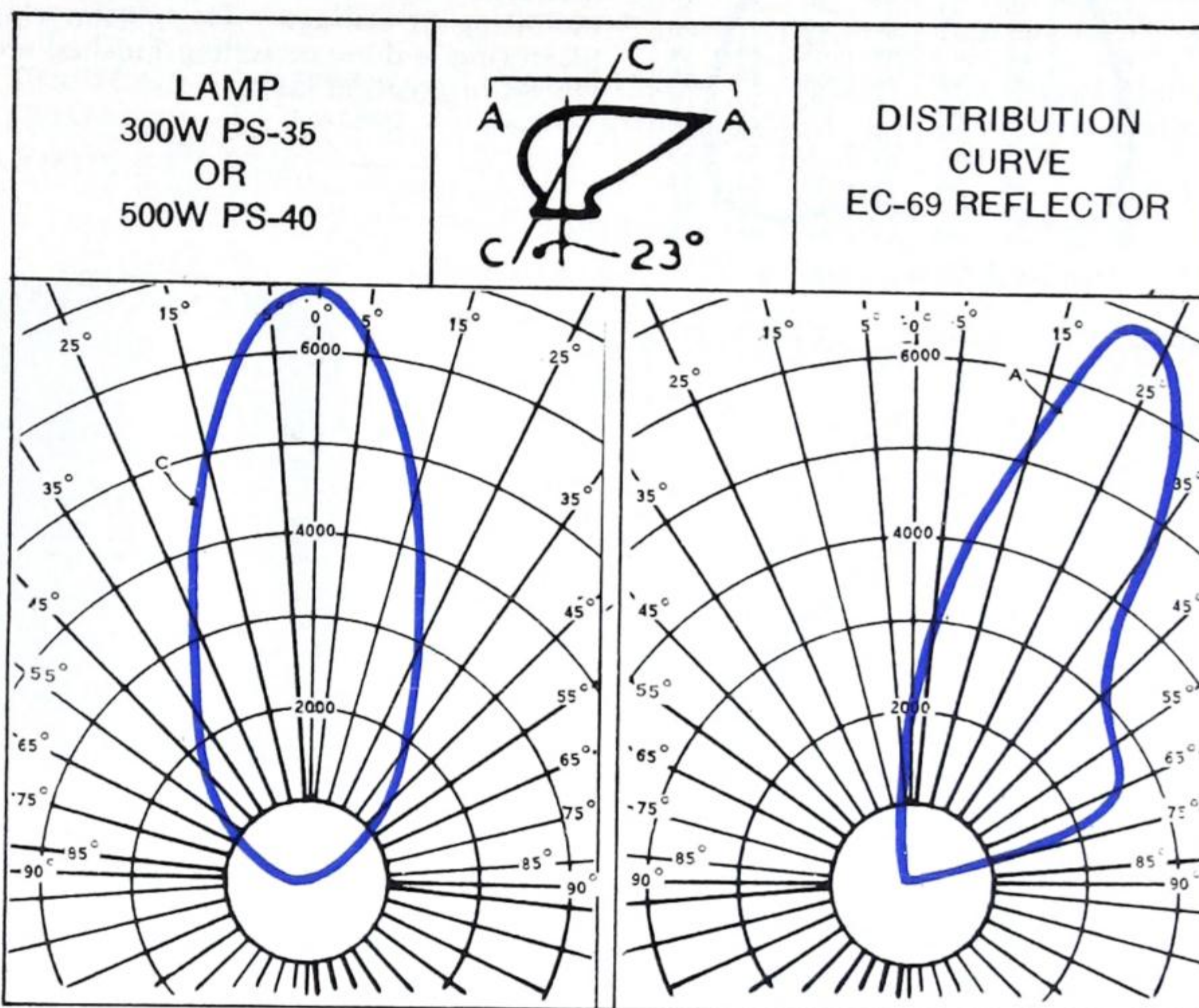

Equipment for Special "Built-In" Applications

For indirect lighting from coves, wall urns, and brackets. Various socket outlet combinations are available to facilitate installation. These employ same silvered glass reflector as the "Urna" Unit.

Dimensions and Spacings			
H	Diameter of Reflector	Maximum Projection	Minimum Spacing
12½"	12⅞"	12⅞"	13½"

Cat. No. Complete Unit	Description
8381	Socket with side outlet included with reflector and holder. For mounting on ½" pipe. Socket with side and back outlet included with reflector and holder. For mounting on ¾" pipe. Socket with side outlet included with reflector and holder. For mounting on ¾" pipe. Box cover socket unit included with reflector and holder. For mounting on 4" outlet boxes.
8382	
8269	
8511	
8503	Reflector and holder only.
EC-69	Reflector only.
10414	Holder only.

Lamp:—300W PS-35, or 500W PS-40 Mogul I.F. Lamp.



ENCLOSED RECESSED UNITS

Curtis Enclosed Units with Silvered Glass Reflectors

SPACING 1.5xMH		EFF 63.0%				
M.F.		0% ↑				
G.70	TYPICAL FOR DISTRIBUTING UNIT WITH GLASS*	63.0% ↓				
M.60						
P.50						
CEILING	75%			50%		
WALLS	50%	30%	10%	50%	30%	10%
ROOM INDEX	COEFFICIENT OF UTILISATION					
J	.35	.34	.32	.36	.33	.32
I	.42	.41	.41	.42	.41	.40
H	.46	.45	.44	.45	.44	.44
G	.49	.48	.48	.48	.47	.46
F	.51	.50	.49	.49	.49	.48
E	.53	.53	.52	.53	.52	.51
D	.57	.54	.54	.55	.54	.53
C	.58	.56	.54	.56	.55	.54
B	.58	.57	.56	.57	.56	.55
A	.59	.58	.57	.58	.56	.56

*REFLECTORS—588-575

SPACING 1.0xMH		EFF 51.0%				
M.F.		0% ↑				
G.70	TYPICAL FOR DISTRIBUTING UNIT WITH LOUVER*	51.0% ↓				
M.60						
P.55						
CEILING	75%			50%		
WALLS	50%	30%	10%	50%	30%	10%
ROOM INDEX	COEFFICIENT OF UTILISATION					
J	.32	.30	.29	.31	.30	.29
I	.38	.36	.36	.37	.36	.35
H	.40	.40	.39	.40	.39	.38
G	.43	.43	.42	.42	.41	.41
F	.45	.44	.43	.43	.42	.42
E	.47	.46	.46	.46	.46	.45
D	.50	.48	.47	.48	.47	.47
C	.51	.49	.48	.49	.48	.47
B	.51	.50	.49	.50	.49	.48
A	.52	.51	.50	.51	.50	.49

*REFLECTORS—585-575

Curtis round housed recessed units includes the choice of a Distributing or Semi-concentrating distribution, and the units are available with cover glass, louver or a combination of both. Typical data for these units is given on this page. The housing is made of 20 gauge steel, finished white inside and black outside. The reflector is mounted on a standard 4" outlet box with holder and porcelain socket. Housing has a flange at the bottom which can be used to support the unit from wood, metal or acoustic ceilings. The hinged rim is attached to this flange with machine screws to complete installation. Hinged rims are finished in warm grey. Plaster rings are available for all units for mounting in ceilings. The plaster ring is installed before plastering is done or ceiling finished and the recessed units placed in position later.



TYPICAL ROUND HOUSED UNIT

SPACING 1xMH		EFF 57.5%				
M.F.		0% ↑				
G.70	TYPICAL FOR SEMI-CONCENTRATING UNIT WITH GLASS*	57.5% ↓				
M.60						
P.50						
CEILING	75%			50%		
WALLS	50%	30%	10%	50%	30%	10%
ROOM INDEX	COEFFICIENT OF UTILISATION					
J	.45	.42	.40	.43	.41	.40
I	.53	.51	.50	.52	.50	.49
H	.57	.56	.55	.56	.55	.54
G	.61	.60	.59	.60	.58	.57
F	.65	.63	.61	.61	.60	.59
E	.67	.66	.65	.65	.64	.62
D	.71	.69	.67	.68	.67	.66
C	.73	.71	.69	.70	.68	.67
B	.74	.72	.71	.71	.69	.68
A	.75	.73	.72	.72	.70	.69

*REFLECTORS—848-810

SPACING .75xMH		EFF 41.5%				
M.F.		0% ↑				
G.70	TYPICAL FOR SEMI-CONCENTRATING UNITS WITH LOUVER*	41.5% ↓				
M.65						
P.55						
CEILING	75%			50%		
WALLS	50%	30%	10%	50%	30%	10%
ROOM INDEX	COEFFICIENT OF UTILISATION					
J	.24	.22	.22	.23	.22	.22
I	.29	.27	.27	.28	.27	.27
H	.30	.30	.29	.30	.29	.29
G	.32	.32	.32	.32	.31	.31
F	.34	.33	.32	.33	.32	.32
E	.35	.35	.34	.35	.34	.34
D	.38	.36	.36	.37	.36	.35
C	.38	.37	.36	.37	.37	.36
B	.39	.38	.37	.38	.37	.37
A	.39	.38	.38	.38	.37	.37

*REFLECTORS—848-810

Distribution	Distributing		Semi-Concentrating		Distributing		Semi-Concentrating	
	2306	2305	—	2315	2326	2325	—	—
COMPLETE UNIT								
200W or 300W Medium Base Lamp	2306	2305	—	2315	2326	2325	—	—
COMPONENT PARTS								
Reflector	575	810	—	810	575	810	—	—
Socket	8051	8051	—	8051	8051	8051	—	—
Holder	10300	10377	—	10377	10300	10377	—	—
Cover Glass	9069	9069	—	—	9069	9069	—	—
Louver	—	—	—	12012	12012	12012	—	—
Hinged Rim	13202-A	13202-A	—	13202-A	13202-A	13202-A	—	—
ACCESSORIES*								
Plaster Ring	14010	14010	—	14010	14010	14010	—	—
Wire Guard	14513-XA	14513-XA	—	14513-XA	—	—	—	—

*Specify separately.



ENCLOSED RECESSED UNITS

Curtis Enclosed Units with Silvered Glass Reflectors

Dimensions Depth.....15 1/4" Diameter.....14 1/2" Flange Rim Width..... 3/4" Hinged Rim Outside Diameter.....16 7/8"						
	Distribution	Distributing	Semi-Concentrating	Distributing	Semi-Concentrating	Distributing
COMPLETE UNIT						
300W or 500W Mogul Base Lamps	2309	2308	—	2318	2329	2328
COMPONENT PARTS						
Reflector	588R	848R	—	848R	588R	848R
Socket	8103	8103	—	8103	8103	8103
Holder	10010	10414	—	10414	10010	10414
Cover Glass	10554	10554	—	—	10554	10554
Louver	—	—	—	12013	12013	12013
Hinged Rim	13203A	13203A	—	13203A	13203A	13203A
ACCESSORIES*						
Plaster Ring	14038	14038	—	14038	14038	14038
Wire Guard	14511-XA	14511-XA	—	14511-XA	—	—

*Specify separately.

Curtis Shallow Housed Recessed Units Without Reflector

Curtis shallow round housed recessed units are designed for installations where the recessing depth is limited. The overall depth is 6" and the units are available for either two 100W or two 40W lamps.

Housing has a flange at the bottom which can be used to support the unit from wood, metal or acoustic ceilings. Hinged rim is attached to this flange by machine screws to complete the installation.

Hinged rim is finished in warm grey. Plaster rings are available for all units for mounting in ceilings. The plaster ring is installed before plastering is done or ceiling finished and the recessed units placed in position later.

These units are supplied complete with crackled glass only or crackled glass and louver, sockets, hinged rim and housing. The shallow round recessed unit does not include a reflector. Finished white inside, black outside.

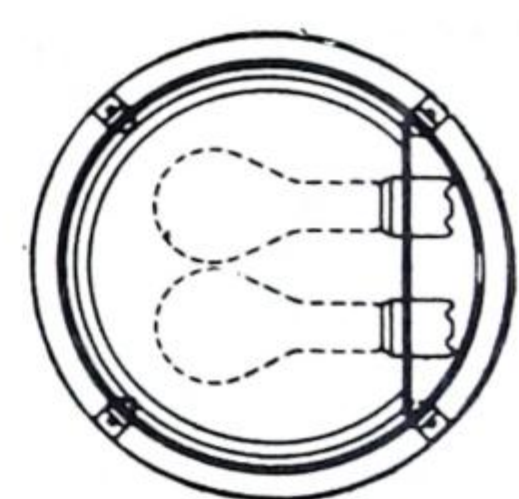

PLASTER RINGS
 For 2302—14038
 For 2301—14010

FOR TWO 100W LAMPS

Type of Unit	Complete Unit	Component Parts				Accessories*	Dimensions	
		Sockets	Hinged Rim	Glass	Louver		Diameter	Depth
With Crackled Cover Glass Only	2302	8051	13203-A	10554	—	14038	14 1/2"	6"
With Crackled Glass and Louver	2322	8051	13203-A	10554	12013	14038	14 1/2"	6"

*Specify separately.

FOR TWO 40W LAMPS

Type of Unit	Complete Unit	Component Parts				Accessories*	Dimensions	
		Sockets	Hinged Rim	Glass	Louver		Diameter	Depth
With Crackled Cover Glass Only	2301	8051	13202A	9069	—	14010	10 7/8"	6"
With Crackled Glass and Louver	2321	8051	13202A	9069	12012	14010	10 7/8"	6"

*Specify separately.

Curtis Rectangular Recessed Units

For those locations where rectangular, instead of round openings will better harmonize with architectural elements or with the decorative scheme, Curtis Lighting makes available special recessed units. In these fixtures the door is pivoted for replacing lamp bulbs and the exterior is so designed that no thumb nuts or screws are visible—FOR FURTHER INFORMATION:

CONSULT YOUR LOCAL NORTHERN ELECTRIC OFFICE

COMMERCIAL LIGHTING

INCANDESCENT

OPEN-TYPE RECESSED UNITS

Curtis Open-Type Units with Silvered Glass Reflectors

Hinged Rim Units for Servicing from Above or Below

Curtis Open-type recessed units use basically two types of reflectors—distributing and semi-concentrating. The units are available with cracked cover glass, guard or louver only or with a combination of glass and guard or glass and louver.

Typical data for units using either glass or louver only for both distributing or semi-concentrating distributions are given on this page. Complete units include socket, holder, reflector, mounting collar and hinged rim or flange. The hinged rim units may be serviced from above or below and the flange units from above only.

Plaster rings are available for all units for mounting in ceilings. The plaster ring is installed before plastering is done or ceiling finished and the recessed units placed in position later.

The Curtis reflector is made of high grade glass, crystal clear and free from discoloration and imperfections. The reflecting element applied to the outer surface of the glass is pure silver. Once mirrored, the silver is then completely protected on the inner side by the glass and on the outer surface by a special protective coating developed by the Curtis Lighting Co.

SPACING 1xMH		EFF 63%				
M.F.	TYPICAL FOR DISTRIBUTING UNIT WITH GLASS*	0%				
G.70		63%				
M.60						
P.50						
CEILING		75%	50%			
WALLS	50% 30% 10%	50% 30% 10%				
ROOM INDEX	COEFFICIENT OF UTILISATION					
J	.35	.34	.32	.36	.34	.32
I	.42	.41	.41	.42	.41	.40
H	.46	.45	.44	.45	.44	.44
G	.49	.48	.48	.48	.47	.46
F	.51	.50	.49	.49	.49	.48
E	.53	.53	.52	.53	.52	.51
D	.57	.54	.54	.55	.54	.53
C	.58	.56	.54	.56	.55	.54
B	.58	.57	.56	.57	.56	.55
A	.59	.58	.57	.58	.56	.56

*REFLECTORS—588R-575-535



SPACING 1xMH		EFF 57.5%				
M.F.	TYPICAL FOR SEMI-CONCENTRATING UNIT WITH GLASS*	0%				
G.70		57.5%				
M.60						
P.50						
CEILING		75%	50%			
WALLS	50% 30% 10%	50% 30% 10%				
ROOM INDEX	COEFFICIENT OF UTILISATION					
J	.45	.42	.40	.43	.41	.40
I	.53	.51	.50	.52	.50	.49
H	.57	.56	.55	.56	.55	.54
G	.61	.60	.59	.60	.58	.57
F	.65	.63	.61	.61	.60	.59
E	.67	.66	.65	.65	.64	.62
D	.71	.69	.67	.68	.67	.66
C	.73	.71	.69	.70	.68	.67
B	.74	.72	.71	.71	.69	.68
A	.75	.73	.72	.72	.70	.69

*REFLECTORS—848R-810

SPACING .75xMH		EFF 51.0%				
M.F.	TYPICAL FOR DISTRIBUTING UNIT WITH LOUVER*	0%				
G.70		51.0%				
M.60						
P.55						
CEILING		75%	50%			
WALLS	50% 30% 10%	50% 30% 10%				
ROOM INDEX	COEFFICIENT OF UTILISATION					
J	.32	.30	.29	.31	.30	.29
I	.38	.36	.36	.37	.36	.35
H	.40	.40	.39	.40	.39	.38
G	.43	.43	.42	.42	.41	.41
F	.45	.44	.43	.43	.42	.42
E	.47	.46	.46	.46	.46	.45
D	.50	.48	.47	.48	.47	.47
C	.51	.49	.48	.49	.48	.47
B	.51	.50	.49	.50	.49	.48
A	.52	.51	.50	.51	.50	.49

*REFLECTORS—588R-575-535

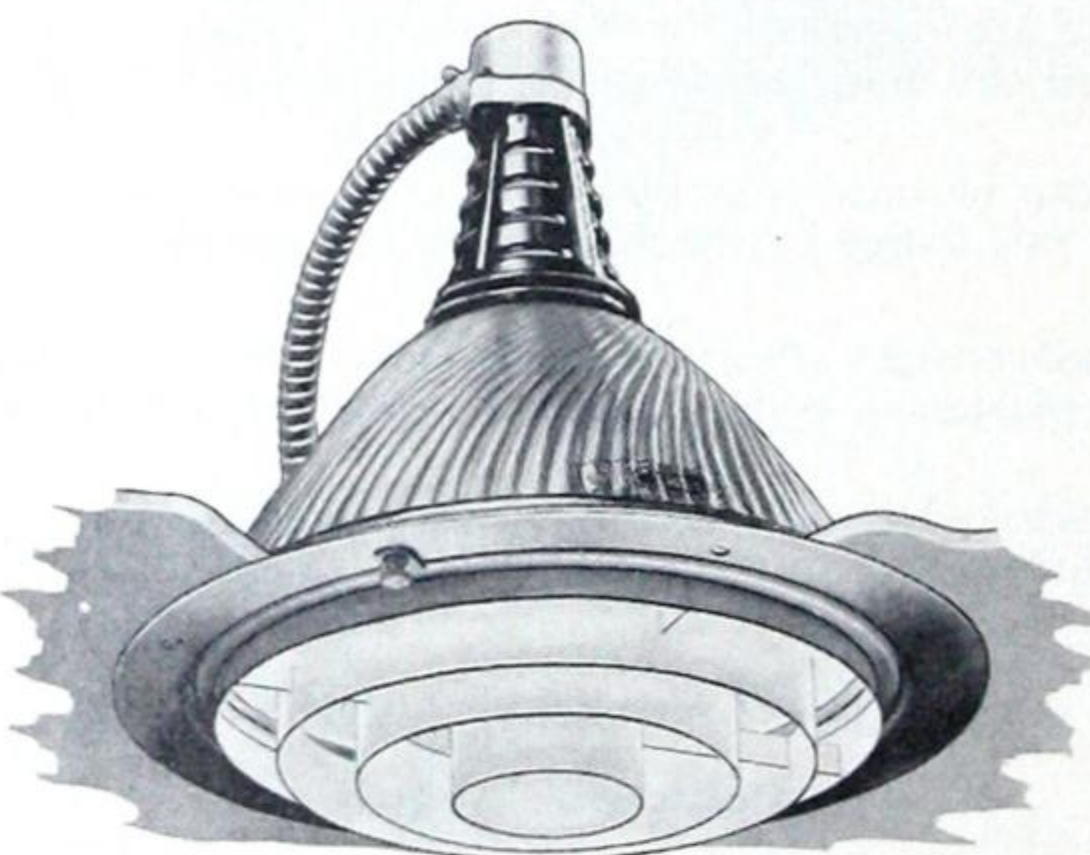

SPACING .75xMH		EFF 41.5%				
M.F.	TYPICAL FOR SEMI-CONCENTRATING UNITS WITH LOUVER*	0%				
G.70		41.5%				
M.65						
P.55						
CEILING		75%	50%			
WALLS	50% 30% 10%	50% 30% 10%				
ROOM INDEX	COEFFICIENT OF UTILISATION					
J	.24	.22	.22	.23	.22	.22
I	.29	.27	.27	.28	.27	.27
H	.30	.30	.29	.30	.30	.29
G	.32	.32	.32	.32	.31	.31
F	.34	.33	.32	.33	.32	.32
E	.35	.35	.34	.35	.34	.34
D	.38	.36	.36	.37	.36	.35
C	.38	.37	.36	.37	.37	.36
B	.39	.38	.37	.38	.37	.37
A	.39	.38	.38	.38	.37	.37

*REFLECTORS—848R-810

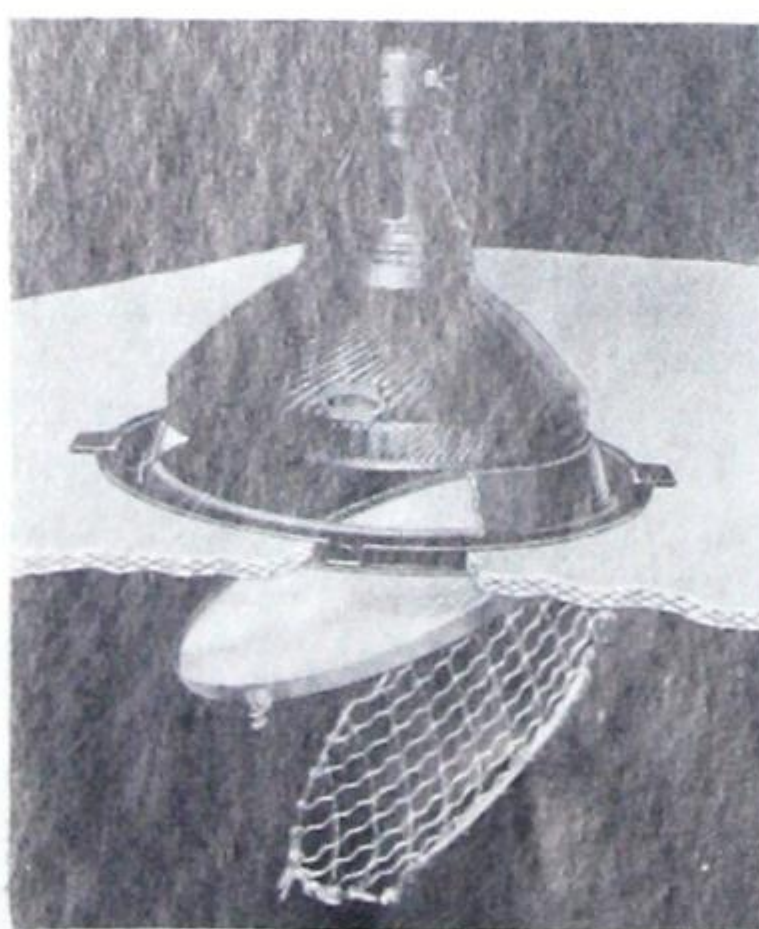

UNIT FOR RELAMPING FROM ABOVE OR BELOW—REFLECTOR SHAPE TYPICAL FOR 848R AND 810

Units	Dimensions		
	A	B	C
2101-A to J	15 1/8**	14 1/2"	16 7/8"
2102-A to J	12 7/8**†	14 1/2"	16 7/8"
2103-A to J	12 7/8**	14 1/2"	16 7/8"
2104-B to J	12 1/2**	10 5/8"	12 5/8"
2106-A to J	12 5/8**	10 5/8"	12 5/8"
2108-A to L	10**	10 5/8"	12 5/8"
2109-B to H	8 3/4**	7 5/8"	9 1/2"

*Add 1/2" to allow minimum clearance for removal of reflector.

†Add 1 1/2" to allow minimum clearance for removal of reflector.

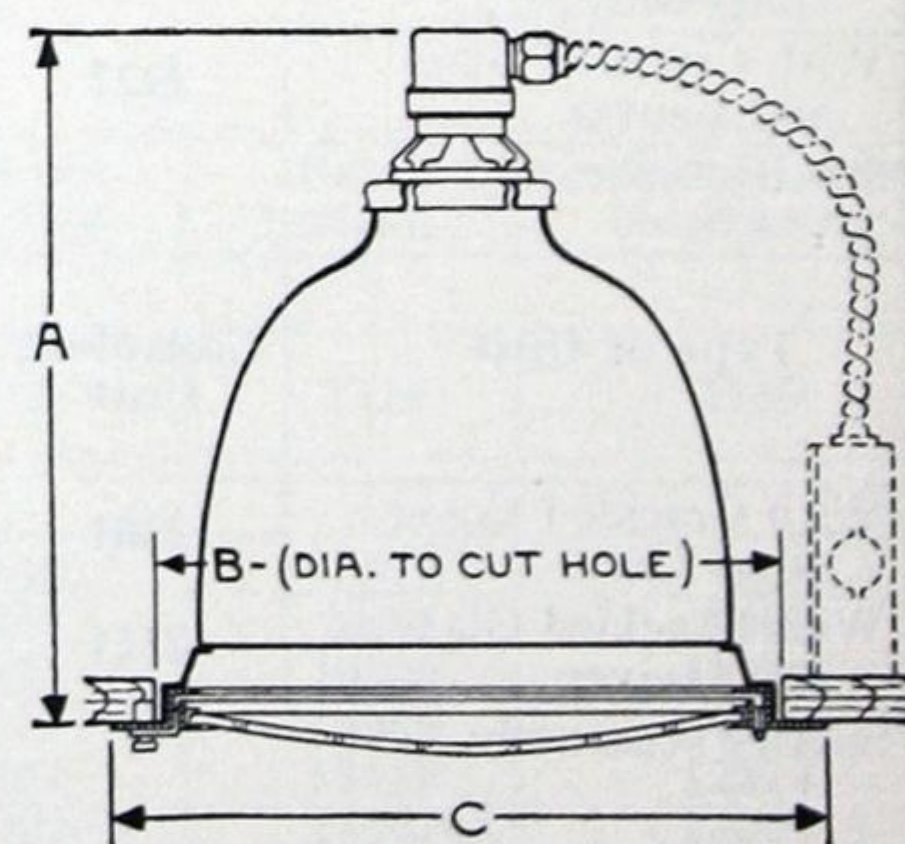

DIMENSIONS—REFLECTOR SHAPE TYPICAL FOR 588R-575-535

OPEN-TYPE RECESSED UNITS

Curtis Open-Type Units with Silvered Glass Reflectors Hinged Rim Units for Servicing from Above or Below



Catalogue numbers include X-Ray reflector, holder, socket and shell, mounting collar and hinged rim as shown.

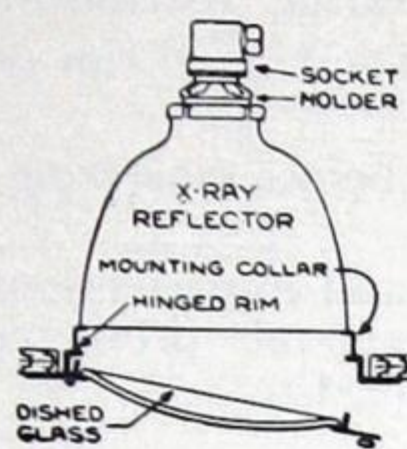

with
Glass Cover only

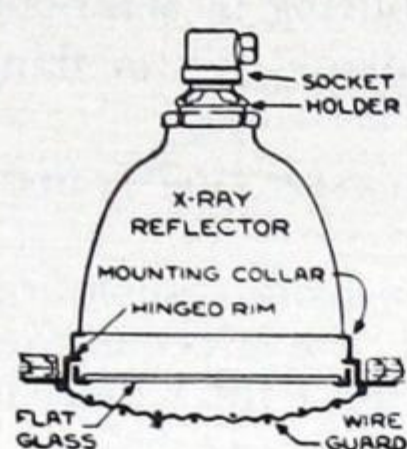

with
Glass and Guard

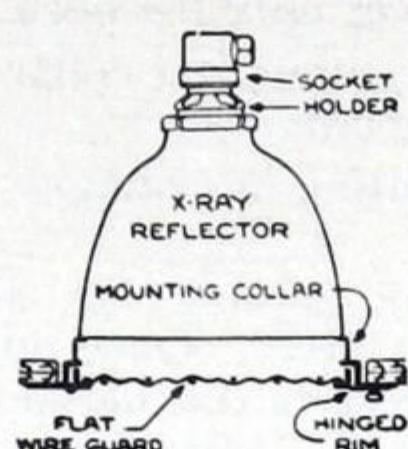

with
Wire Guard only

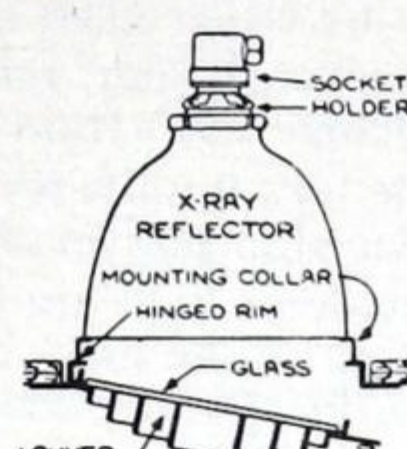

with
Glass and Louver
(Crackled Glass)

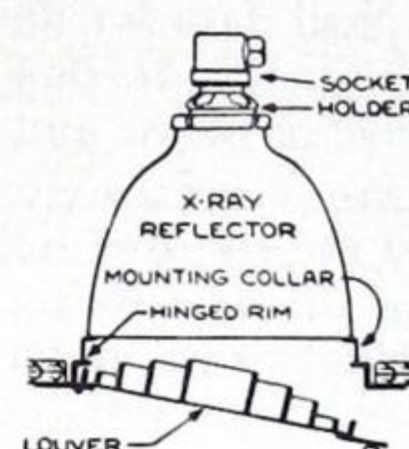

with
Louver only

Distribution	Distri- buting	Semi- Concen- trating	Distri- buting	Semi- Concen- trating	Distri- buting	Semi- Concen- trating	Distri- buting	Semi- Concen- trating	Distri- buting	Semi- Concen- trating
COMPLETE UNITS—100W										
100W	2109B	—	2109D	—	2109E	—	2109F	—	2109H	—
COMPONENT PARTS										
Socket	8251S	—	8251S	—	8251S	—	8251S	—	8251S	—
Holder	10127	—	10127	—	10127	—	10127	—	10127	—
Reflector	535	—	535	—	535	—	535	—	535	—
Mounting Collar	13152	—	13152	—	13152	—	13152	—	13152	—
Hinged Rim	13201A	—	13201A	—	13201A	—	13201A	—	13201A	—
Cover Glass	10552	—	10552	—	—	—	10552	—	—	—
Wire Guard	—	—	14512XA	—	14509XA	—	—	—	—	—
Louver	—	—	—	—	—	—	12014	—	12014	—
ACCESSORIES*										
Plaster Ring	14011	—	14011	—	14011	—	14011	—	14011	—

*Specify separately.

COMPLETE UNITS—200W-300W										
Distribution	Distri- buting	Semi- Concen- trating	Distri- buting	Semi- Concen- trating	Distri- buting	Semi- Concen- trating	Distri- buting	Semi- Concen- trating	Distri- buting	Semi- Concen- trating
200W-300W Medium Base	2104B	2108A	2104D	2108C	2104E	2108E	2104F	2108F	—	2108H
COMPONENT PARTS										
Socket	8251S	8251S	8251S	8251S	8251S	8251S	8251S	8251S	—	8251S
Holder	10300	10377	10300	10377	10300	10377	10300	10377	—	10377
Reflector	575	810	575	810	575	810	575	810	—	810
Mounting Collar	13154	13155	13154	13155	13154	13155	13154	13155	—	13155
Hinged Rim	13202A	13202A	13202A	13202A	13202A	13202A	13202A	13202A	—	13202A
Cover Glass	9069	9069	9069	9069	—	—	9069	9069	—	—
Wire Guard	—	—	14513XA	14513XA	14510XA	14510XA	—	—	—	—
Louver	—	—	—	—	—	—	12012	12012	—	12012
ACCESSORIES*										
Plaster Ring	14010	14010	14010	14010	14010	14010	14010	14010	—	14010

*Specify separately.

COMPLETE UNITS—300W-500W										
Distribution	Distri- buting	Semi- Concen- trating	Distri- buting	Semi- Concen- trating	Distri- buting	Semi- Concen- trating	Distri- buting	Semi- Concen- trating	Distri- buting	Semi- Concen- trating
300W-500W Mogul Base	2101A	2102A	2101C	2102C	2101E	2102E	2101F	2102F	2101H	2102H
COMPONENT PARTS										
Socket	8301S	8301S	8301S	8301S	8301S	8301S	8301S	8301S	8301S	8301S
Holder	10010	10414	10010	10414	10010	10414	10010	10414	10010	10414
Reflector	588R	848R	588R	848R	588R	848R	588R	848R	588R	848R
Mounting Collar	13157	13158	13157	13158	13157	13158	13157	13158	13157	13158
Hinged Rim	13203A	13203A	13203A	13203A	13203A	13203A	13203A	13203A	13203A	13203A
Cover Glass	10554	10554	10554	10554	—	—	10554	10554	—	—
Wire Guard	—	—	14514XA	14514XA	14511XA	14511XA	—	—	—	—
Louver	—	—	—	—	—	—	12013	12013	12013	12013
ACCESSORIES*										
Plaster Ring	14038	14038	14038	14038	14038	14038	14038	14038	14038	14038

*Specify separately.

COMMERCIAL LIGHTING
INCANDESCENT

OPEN-TYPE RECESSED UNITS

Curtis Open-Type Units with Silvered Glass Reflectors
Flange Type Units for Servicing from Above Only

Curtis Open-type recessed units use basically two types of reflectors—distributing and semi-concentrating. The units are available with crackled cover glass, guard or louver only or with a combination of glass and guard or glass and louver.

Typical data for units using either glass or louver only for both distributing or semi-concentrating distributions are given on this page. Complete units include socket, holder, reflector, mounting collar and hinged rim or flange. The hinged rim units may be serviced from above or below and the flange units from above only.

Plaster rings are available for all units for mounting in ceilings. The plaster ring is installed before plastering is done or ceiling finished and the recessed units placed in position later.

The Curtis reflector is made of high grade glass, crystal clear and free from discoloration and imperfections. The reflecting element applied to the outer surface of the glass is pure silver. Once mirrored, the silver is then completely protected on the inner side by the glass and on the outer surface by a special protective coating developed by the Curtis Lighting Co.

SPACING 1xMH		EFF 63.0%	
M.F.	TYPICAL FOR DISTRIBUTING UNIT WITH GLASS*	0% ↑	
G.70		63.0% ↓	
M.60			
P.50			
CEILING	75%	50%	
WALLS	50%	30%	10%
	50%	30%	10%
ROOM INDEX	COEFFICIENT OF UTILISATION		
J	.35	.34	.32
I	.42	.41	.41
H	.46	.45	.44
G	.49	.48	.48
F	.51	.50	.49
E	.53	.53	.52
D	.57	.54	.54
C	.58	.56	.56
B	.59	.57	.57
A	.59	.58	.56

*REFLECTORS—588-575-535



SPACING 1xMH		EFF 57.5%	
M.F.	TYPICAL FOR SEMI-CONCENTRATING UNIT WITH GLASS*	0% ↑	
G.70		57.5% ↓	
M.60			
P.50			
CEILING	75%	50%	
WALLS	50%	30%	10%
	50%	30%	10%
ROOM INDEX	COEFFICIENT OF UTILISATION		
J	.45	.42	.40
I	.53	.51	.50
H	.57	.56	.55
G	.61	.60	.59
F	.65	.63	.61
E	.67	.66	.65
D	.71	.69	.68
C	.73	.71	.70
B	.74	.72	.71
A	.75	.73	.72

*REFLECTORS—848R-810

SPACING .75xMH		EFF 51.0%	
M.F.	TYPICAL FOR DISTRIBUTING UNIT WITH LOUVER*	0% ↑	
G.70		51.0% ↓	
M.60			
P.55			
CEILING	75%	50%	
WALLS	50%	30%	10%
	50%	30%	10%
ROOM INDEX	COEFFICIENT OF UTILISATION		
J	.32	.30	.29
I	.38	.36	.36
H	.40	.40	.39
G	.43	.43	.42
F	.45	.44	.43
E	.47	.46	.46
D	.50	.48	.47
C	.51	.49	.48
B	.51	.50	.49
A	.52	.51	.50

*REFLECTORS—588-575-535

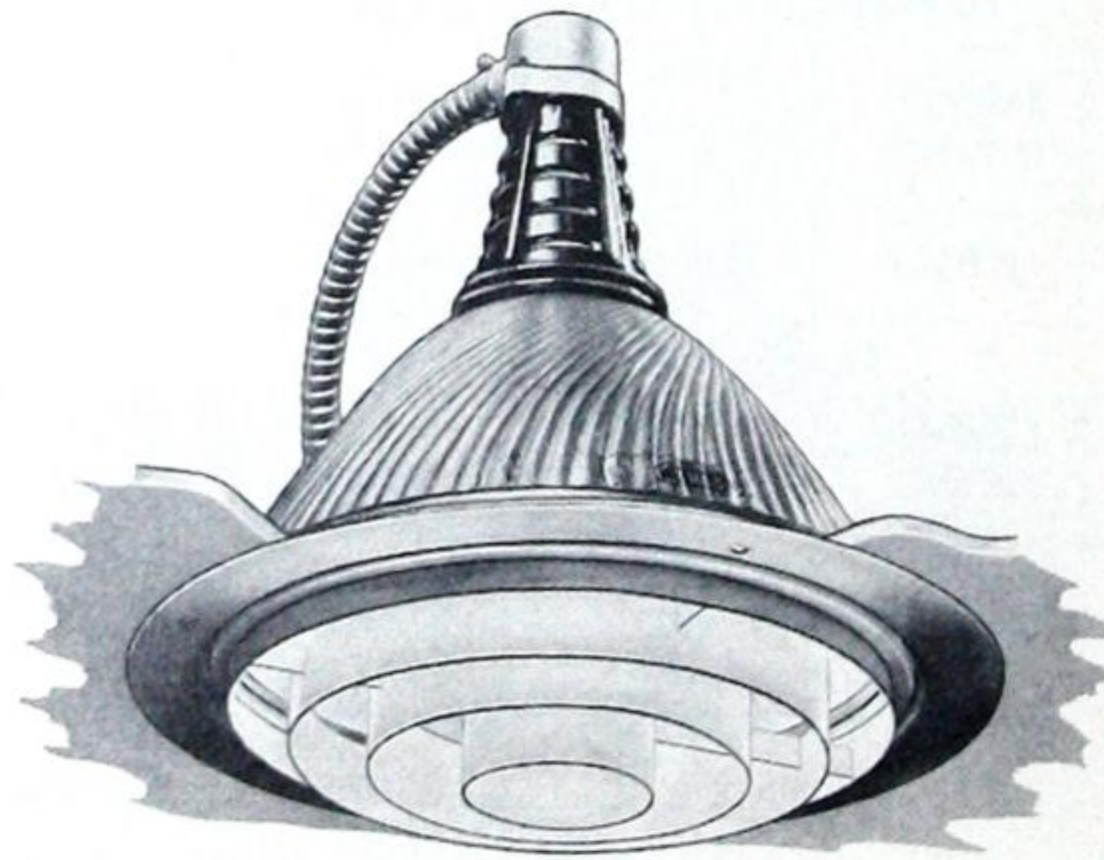

SPACING .75xMH		EFF 41.5%	
M.F.	TYPICAL FOR SEMI-CONCENTRATING UNITS WITH LOUVER*	0% ↑	
G.70		41.5% ↓	
M.65			
P.55			
CEILING	75%	50%	
WALLS	50%	30%	10%
	50%	30%	10%
ROOM INDEX	COEFFICIENT OF UTILISATION		
J	.24	.22	.22
I	.29	.27	.27
H	.30	.30	.29
G	.32	.32	.32
F	.34	.33	.32
E	.35	.35	.34
D	.38	.36	.36
C	.38	.37	.37
B	.39	.38	.38
A	.39	.38	.37

*REFLECTORS—848R-810



UNIT FOR SERVICING FROM ABOVE ONLY—REFLECTOR SHADE TYPICAL FOR 848R AND 810

Units	Dimensions		
	A	B	C
2111-A to J	15 1/8"*	14 5/8"	16 7/8"
2112-A to J	12 7/8"†	14 5/8"	16 7/8"
2113-A to J	12 7/8"†	14 5/8"	16 7/8"
2114-B to J	12 1/2"*	10 5/8"	12 1/2"
2115-F & G	11"*	10 5/8"	12 1/2"
2116-A to J	12 5/8"*	10 5/8"	12 1/2"
2118-A to L	10"*	10 5/8"	12 1/2"
2119-B to H	8 3/4"*	7 5/8"	9 1/4"

*Add 1/2" to allow minimum clearance for removal of reflector.

†Add 1 1/2" to allow minimum clearance for removal of reflector.

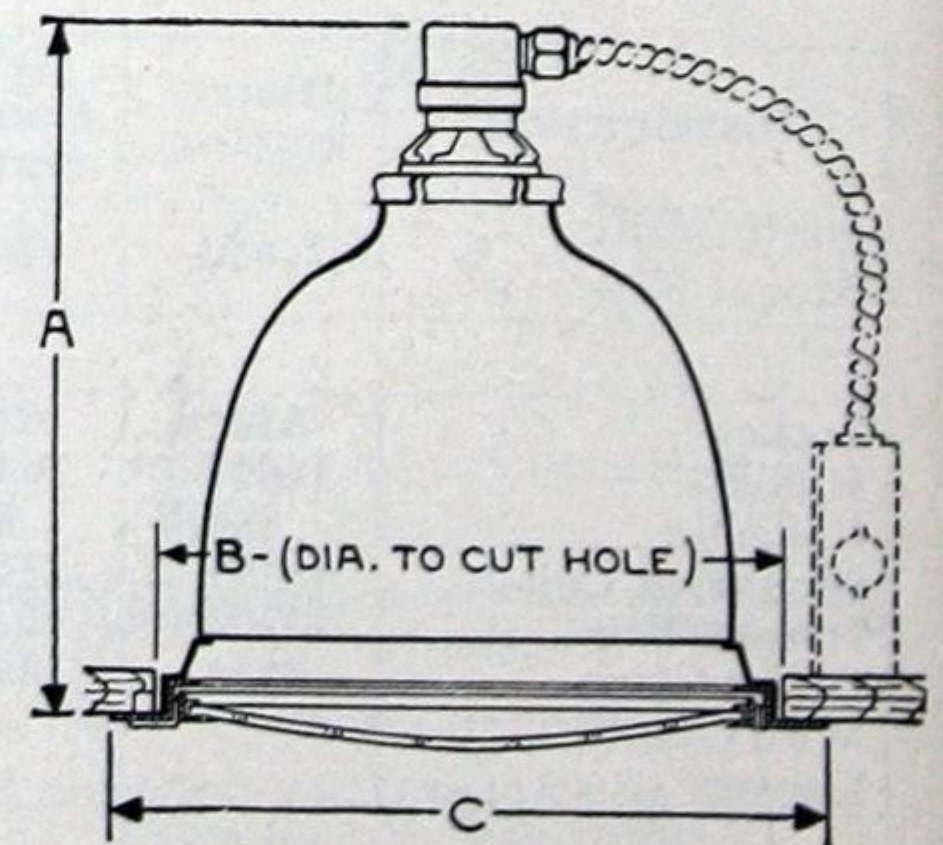

DIMENSIONS—REFLECTOR SHADE TYPICAL FOR 588-575-535



OPEN-TYPE RECESSED UNITS

Curtis Open-Type Units with Silvered Glass Reflectors

Flange Type Units for Servicing from Above Only

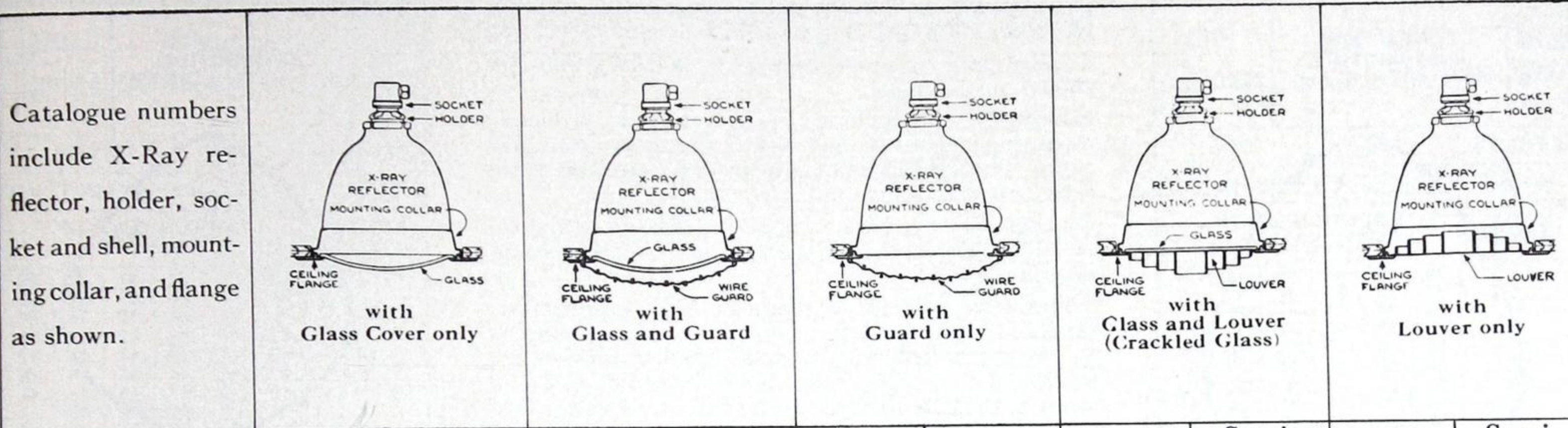

Distribution	Distributing	Semi-Concentrating	Distributing	Semi-Concentrating	Distributing	Semi-Concentrating	Distributing	Semi-Concentrating	Distributing	Semi-Concentrating
--------------	--------------	--------------------	--------------	--------------------	--------------	--------------------	--------------	--------------------	--------------	--------------------

COMPLETE UNITS—100W

100W	2119B	—	2119D	—	2119E	—	2119F	—	2119H	—
------	-------	---	-------	---	-------	---	-------	---	-------	---

COMPONENT PARTS

Socket	8251S	—	8251S	—	8251S	—	8251S	—	8251S	—
Holder	10127	—	10127	—	10127	—	10127	—	10127	—
Reflector	535	—	535	—	535	—	535	—	535	—
Mounting Collar	13152	—	13152	—	13152	—	13152	—	13152	—
Flange	13204A	—	13204A	—	13204A	—	13204A	—	13204A	—
Cover Glass	10552	—	10552	—	—	—	10552	—	—	—
Wire Guard	—	—	14512XA	—	14509XA	—	—	—	—	—
Louver	—	—	—	—	—	—	12014	—	12014	—

ACCESSORIES*

Plaster Ring	14011	—	14011	—	14011	—	14011	—	14011	—
--------------	-------	---	-------	---	-------	---	-------	---	-------	---

*Specify separately.

COMPLETE UNITS—200W-300W

Distribution	Distributing	Semi-Concentrating	Distributing	Semi-Concentrating	Distributing	Semi-Concentrating	Distributing	Semi-Concentrating	Distributing	Semi-Concentrating
200W-300W Medium Base	2114B	2118A	2114D	2118C	2114E	2118E	2114F	2118F	—	2118K

COMPONENT PARTS

Socket	8251S	8251S	8251S	8251S	8251S	8251S	8251S	8251S	—	8251S
Holder	10300	10377	10300	10377	10300	10377	10300	10377	—	10377
Reflector	575	810	575	810	575	810	575	810	—	810
Mounting Collar	13154	13155	13154	13155	13154	13155	13154	13155	—	13155
Hinged Flange	13205A	13205A	13205A	13205A	13205A	13205A	13205A	13205A	—	13205A
Cover Glass	9069	9069	9069	9069	—	—	9069	9069	—	—
Wire Guard	—	—	14513XA	14513XA	14510XA	14510XA	—	—	—	—
Louver	—	—	—	—	—	—	12012	12012	—	12012

ACCESSORIES*

Plaster Ring	14010	14010	14010	14010	14010	14010	14010	14010	—	14010
--------------	-------	-------	-------	-------	-------	-------	-------	-------	---	-------

*Specify separately.

COMPLETE UNITS—300W-500W

Distribution	Distributing	Semi-Concentrating	Distributing	Semi-Concentrating	Distributing	Semi-Concentrating	Distributing	Semi-Concentrating	Distributing	Semi-Concentrating
300W-500W Mogul Base	2111A	2112A	2111C	2112C	2111E	2112E	2111F	2112F	2111H	2112H

COMPONENT PARTS

Socket	8301S	8301S	8301S	8301S	8301S	8301S	8301S	8301S	8301S	8301S
Holder	10010	10414	10010	10414	10010	10414	10010	10414	10010	10414
Reflector	588R	848R	588R	848R	588R	848R	588R	848R	588R	848R
Mounting Collar	13157	13158	13157	13158	13157	13158	13157	13158	13157	13158
Flange	13206A	13206A	13206A	13206A	13206A	13206A	13206A	13206A	13206A	13206A
Cover Glass	10554	10554	10554	10554	—	—	10554	10554	—	—
Wire Guard	—	—	14514XA	14514XA	14511XA	14511XA	—	—	—	—
Louver	—	—	—	—	—	—	12013	12013	12013	12013

ACCESSORIES*

Plaster Ring	14038	14038	14038	14038	14038	14038	14038	14038	14038	14038
--------------	-------	-------	-------	-------	-------	-------	-------	-------	-------	-------

*Specify separately.

COMMERCIAL LIGHTING
INCANDESCENT



OPEN TYPE RECESSED UNITS

Curtis Open Type Units With Silvered Glass Reflectors

SPACING 1.5xMH		EFF 63.0%	
M.F.	TYPICAL FOR DISTRIBUTING UNIT WITH GLASS*	0% ↑	
G.70		63.0% ↓	
M.60			
P.50			
CEILING	75%	50%	
WALLS	50% 30% 10%	50% 30% 10%	
ROOM INDEX	COEFFICIENT OF UTILISATION		
J	.35	.34	.32
I	.42	.41	.41
H	.46	.45	.44
G	.49	.48	.48
F	.51	.50	.49
E	.53	.53	.52
D	.57	.54	.54
C	.58	.56	.56
B	.58	.57	.57
A	.59	.58	.58

*REFLECTORS—585-575

Curtis Open-type recessed units using distributing type reflectors and available with cracked cover glass, guard, or louver only or with a combination of glass and guard or glass and louver.

Typical data for units using glass or louver only are shown on this page.

Complete unit includes socket, holder, reflector, mounting collar, hinged rim or flange and plaster ring. The hinged rim units may be serviced from below and the flange units from above only.

The plaster ring is installed before plastering is done or ceiling finished and the recessed unit placed in position later.

The Curtis reflector is made of high grade glass, crystal clear and free from discoloration and imperfections. The reflecting element applied to the outer surface of the glass is pure silver. Once mirrored, the silver is then completely protected on the inner side by the glass and on the outer surface by a special protective coating developed by the Curtis Lighting Company.

SPACING 1.0xMH		EFF 51.0%	
M.F.	TYPICAL FOR DISTRIBUTING UNIT WITH LOUVER*	0% ↑	
G.70		51.0% ↓	
M.60			
P.55			
CEILING	75%	50%	
WALLS	50% 30% 10%	50% 30% 10%	
ROOM INDEX	COEFFICIENT OF UTILISATION		
J	.32	.30	.29
I	.38	.36	.36
H	.40	.40	.39
G	.43	.43	.42
F	.45	.44	.43
E	.47	.46	.46
D	.50	.48	.47
C	.51	.49	.48
B	.51	.50	.49
A	.52	.51	.50

*REFLECTORS—588-575

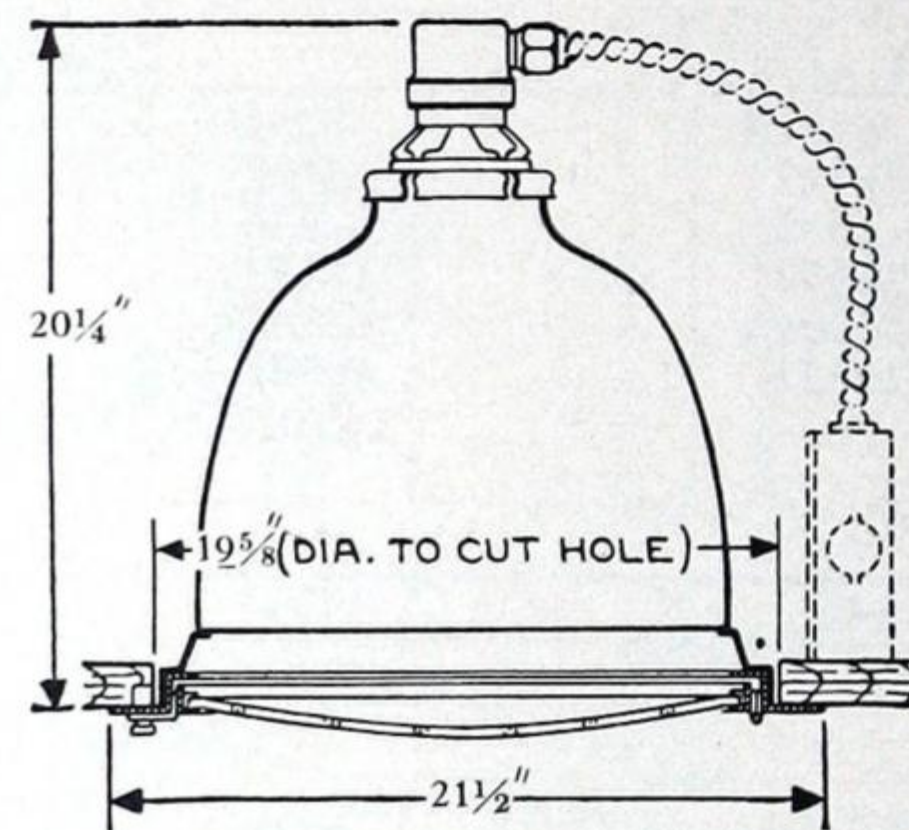
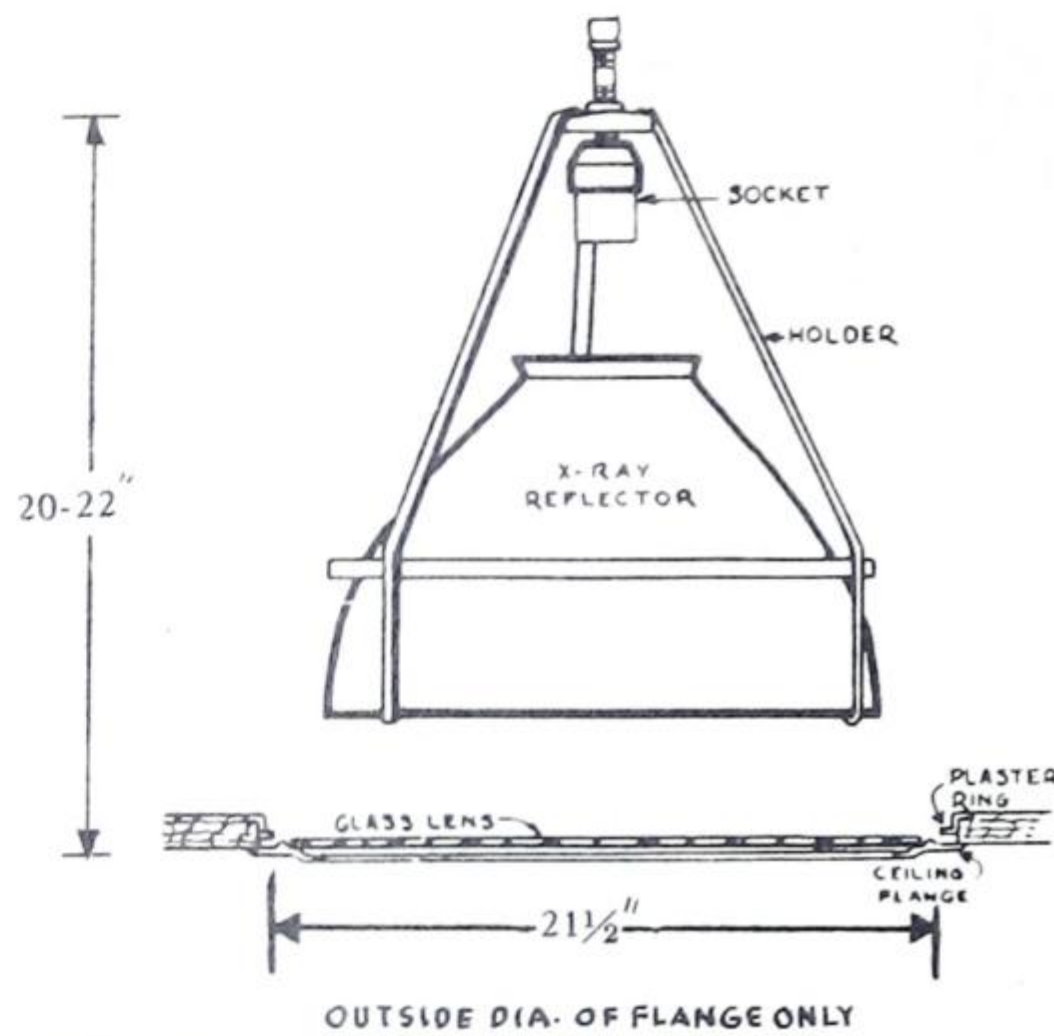

For Relamping From Below Only

Type of Unit										
	Cover Glass Only	Glass and Guard	Guard Only	Glass and Louver	Louver Only					
Distribution	Distributing	Semi-Concentrating	Distributing	Semi-Concentrating	Distributing	Semi-Concentrating	Distributing	Semi-Concentrating	Distributing	Semi-Concentrating
	COMPLETE UNIT									
750W-1500W Mogul Base	M-179RB	—	M-180RB	—	M-182RB	—	M-181RB	—	M-183RB	—
COMPONENT PARTS										
Socket	8300-B	—	8300-B	—	8300-B	—	8300-B	—	8300-B	—
Holder	Tripod	—	Tripod	—	Tripod	—	Tripod	—	Tripod	—
Reflector	589-R	—	589-R	—	589-R	—	589-R	—	589-R	—
Hinged Rim	13226-A	—	13226-A	—	13226-A	—	13226-A	—	13226-A	—
Cover Glass	9051-F	—	9051-F	—	—	—	9051-F	—	—	—
Wire Guard	—	—	14526-XA	—	14526-XA	—	—	—	—	—
Louver	—	—	—	—	—	—	D-774	—	D-774	—
Plaster Ring	D-821R1	—	D-821R1	—	D-821R1	—	D-821R1	—	D-821R1	—



OPEN-TYPE RECESSED UNITS

Curtis Open Type Units With Silvered Glass Reflectors

For Relamping From Above Only

Type of Unit	Cover Glass Only		Glass and Guard		Guard Only		Glass and Louver		Louver Only	
	Distributing	Semi-Concentrating	Distributing	Semi-Concentrating	Distributing	Semi-Concentrating	Distributing	Semi-Concentrating	Distributing	Semi-Concentrating
COMPLETE UNIT										
750W-1500W Mogul Base	M-179	—	M-180	—	M-182	—	M-181	—	M-183	—
COMPONENT PARTS										
Socket Holder Reflector Mounting Collar Flange Cover Glass Wire Guard Louver Plaster Ring	8301-S D-752-RH 589-R D-752-RMC 13226-A 9051-F — — D-821R1	— — — — — — — — —	8301-S D-752-RH 589-R D-752-RMC 13226-A 9051-F 14526-XA — D-821R1	— — — — — — — — —	8301-S D-752-RH 589-R D-752-RMC 13226-A — 14526-XA — D-821R1	— — — — — — — — —	8301-S D-752-RH 589-R D-752-RMC 13226-A 9051-F — D-774 D-821R1	— — — — — — — — —	8301-S D-752-RH 589-R D-752-RMC 13226-A — — D-774 D-821R1	— — — — — — — — —

2120, 2130 Series

These two Curtis low-priced recessed units are suitable for locations where no cover glass or guard is required. The reflector rests directly on the ceiling flange and may be serviced from above or below. The louver is not hinged but may be easily removed from below the unit for servicing. Complete units include socket, four-inch outlet box cover or 1/2" side outlet shell and socket assembly, reflector and ceiling flange. The ceiling flange may be used for mounting in wood, metal or acoustic ceiling. Plaster rings are available for all units for mounting in ceilings. The plaster ring is installed before plastering is done or ceiling finished and the recessed units placed in position later.

SPACING 1.5xMH		EFF 83.0%				
M.F.	DISTRIBUTING DISTRIBUTION	0% ↑				
G.80	2120 H & K	83.0% ↓				
M.75						
P.70						
CEILING	75%	50%				
WALLS	50%	30%	10%	50%	30%	10%
ROOM INDEX	COEFFICIENT OF UTILISATION					
J	.47	.45	.42	.45	.44	.42
I	.56	.53	.52	.54	.53	.51
H	.60	.59	.58	.58	.57	.57
G	.64	.63	.62	.62	.61	.60
F	.67	.65	.64	.64	.63	.62
E	.69	.68	.67	.68	.67	.66
D	.73	.71	.70	.71	.70	.69
C	.75	.73	.71	.73	.71	.71
B	.76	.74	.73	.74	.73	.71
A	.77	.76	.74	.75	.73	.72



SPACING 1.5xMH		EFF 73.8%				
M.F.	DISTRIBUTING DISTRIBUTION	0% ↑				
G.80	2130 H & K	73.8% ↓				
M.75						
P.70						
CEILING	75%	50%				
WALLS	50%	30%	10%	50%	30%	10%
ROOM INDEX	COEFFICIENT OF UTILISATION					
J	.47	.45	.42	.45	.44	.42
I	.56	.53	.52	.54	.53	.51
H	.60	.59	.58	.58	.57	.57
G	.64	.63	.62	.62	.61	.60
F	.67	.65	.64	.64	.63	.62
E	.69	.68	.67	.68	.67	.66
D	.73	.71	.70	.71	.70	.69
C	.75	.73	.71	.73	.71	.71
B	.76	.74	.73	.74	.72	.71
A	.77	.76	.74	.75	.73	.72

Complete Unit	Lamp Watts	Component Parts				Accessories*	
		Socket	Holder	Reflector	Flange	Louver	Plaster Ring
2130H†	200W-300W Medium Base	8251S	10300	575	14021	12023	14028
2120H†	300W-500W Mogul Base	8301S	10010	588R	14025	12022	14312
2130K††	200W-300W Medium Base	10146B	10300	575	14021	12023	14028
2120K††	300W-500W Mogul Base	8301S	10010	588R	14025	12022	14312

*Specify separately. †With side entry socket tapped 1/2". ††With four inch outlet box cover.

HOLOPHANE PRISMATIC GLASSWARE

Light Control

The development of the Controlens (R) means that the light normally reaching the upper portion of the room is reflected or bent downward into a definite predetermined pattern so as to fit the area or subject to be lighted. No longer does the large amount of light formerly emitted at high angles produce annoying glare; it is now joined to the downward light to increase the effective illumination—exactly where it is needed.

Numerous types of Controlenses are available; each one to be used in conjunction with a particular reflector. These fall broadly into three classes:

1. Symmetrical lenses producing various widths of beam.
2. Symmetrical lenses capable of projecting the light off to one side—commonly called "offset".
3. Asymmetric lenses (non-symmetrical) which spread the light wide on one axis and "squeeze" it narrow at right angles.

The three classifications above suggest the commonest use of these lenses. Actually, the combinations of optical arrangements and lighting effects which can be secured are practically inexhaustible.



The following illustrations show, in a simplified form, some of the elementary actions of the lenses when refracting the rays from a symmetrical light source.

By combining all of the possible variations in focus and lamp offsets, an infinite number of divergences and asymmetry of beam are made available. Selection of the proper combination ensures maximum illumination for any specific application.

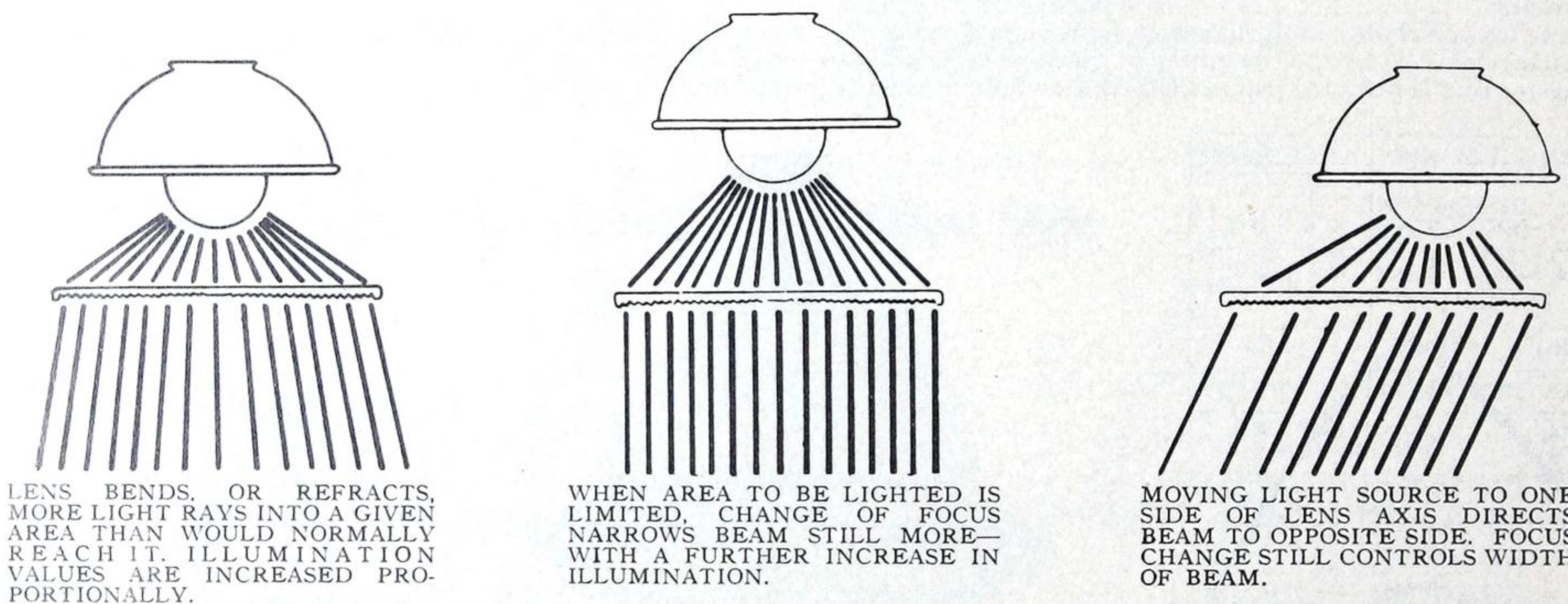

LENS BENDS, OR REFRACTS, MORE LIGHT RAYS INTO A GIVEN AREA THAN WOULD NORMALLY REACH IT. ILLUMINATION VALUES ARE INCREASED PROPORTIONALLY.

WHEN AREA TO BE LIGHTED IS LIMITED, CHANGE OF FOCUS NARROWS BEAM STILL MORE—WITH A FURTHER INCREASE IN ILLUMINATION.

MOVING LIGHT SOURCE TO ONE SIDE OF LENS AXIS DIRECTS BEAM TO OPPOSITE SIDE. FOCUS CHANGE STILL CONTROLS WIDTH OF BEAM.

The various advantages can be summarized as follows:

1. High illumination values.
2. Greater visibility for any given lighting level due to better disposition of brightness in the field of view.
3. The initial and "average-through life" results can be accurately predicted.
4. Glass surfaces are subject to no permanent depreciation. Ordinary washing compounds will restore them to initial efficiency.
5. Low cost per foot-candle per year because of better maintenance—due to enclosed construction.
6. Adaptable to nearly all architectural styles.
7. Lenses are available for either incandescent or fluorescent lamps.

Because of the great variety and combinations of prismatic units, a word of caution should be inserted here, and attention called to the fact that the application of any such lighting unit—other than those mentioned for a specific purpose and instructions given—must receive study so that the proper light distribution is used. The *Northern Electric Lighting Service* is available without obligation to assist you in obtaining the most suitable optical set-up which will produce the results desired.

(R) The Holophane Co. Ltd.



Introducing the Holophane

No. F-1570

**Featuring a New Lo-Brite
Concave Controlens (R)
For Reduced Brightness,
Increased Efficiency
and Maximum
Visual Comfort**

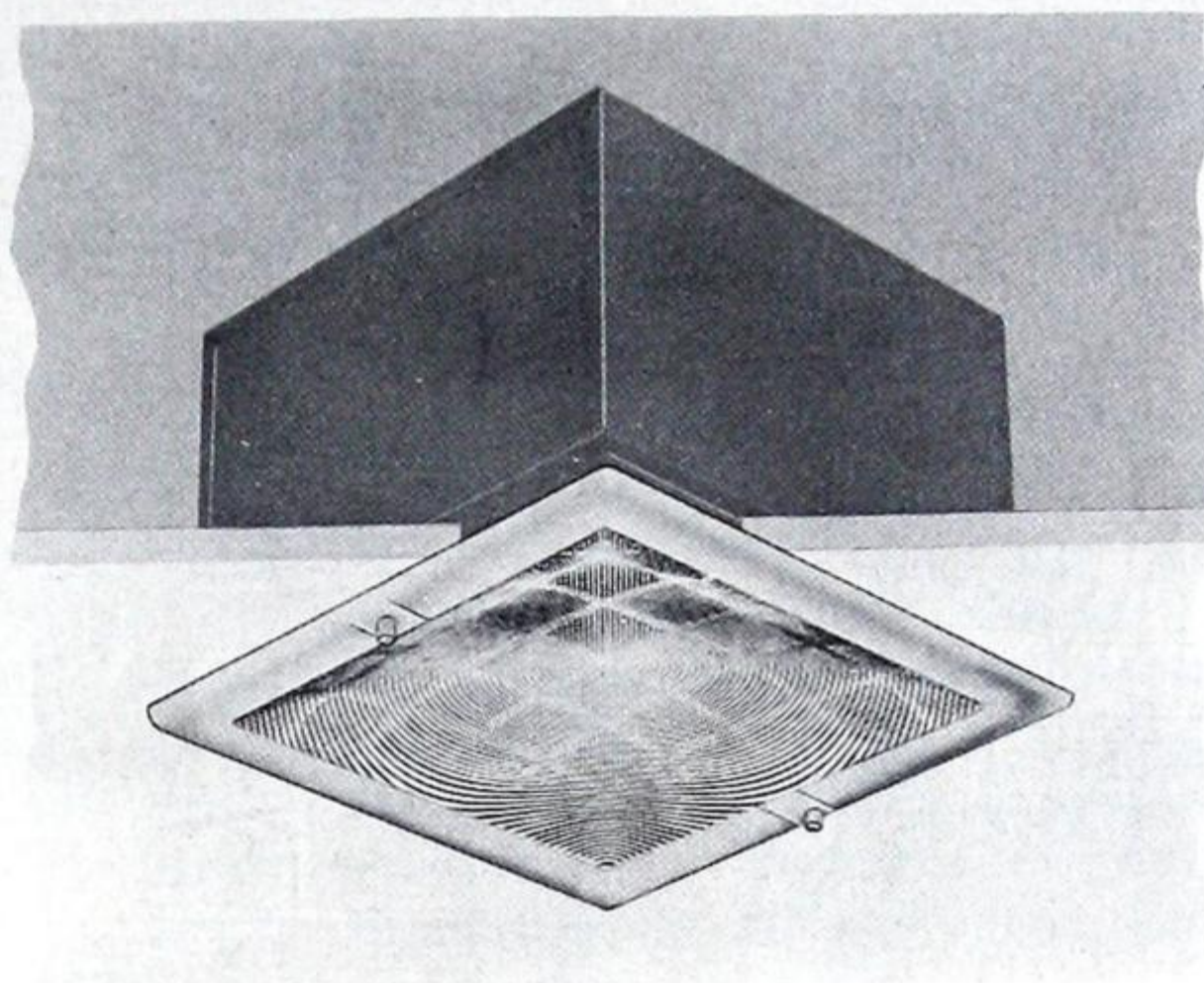

Why it is Less Bright

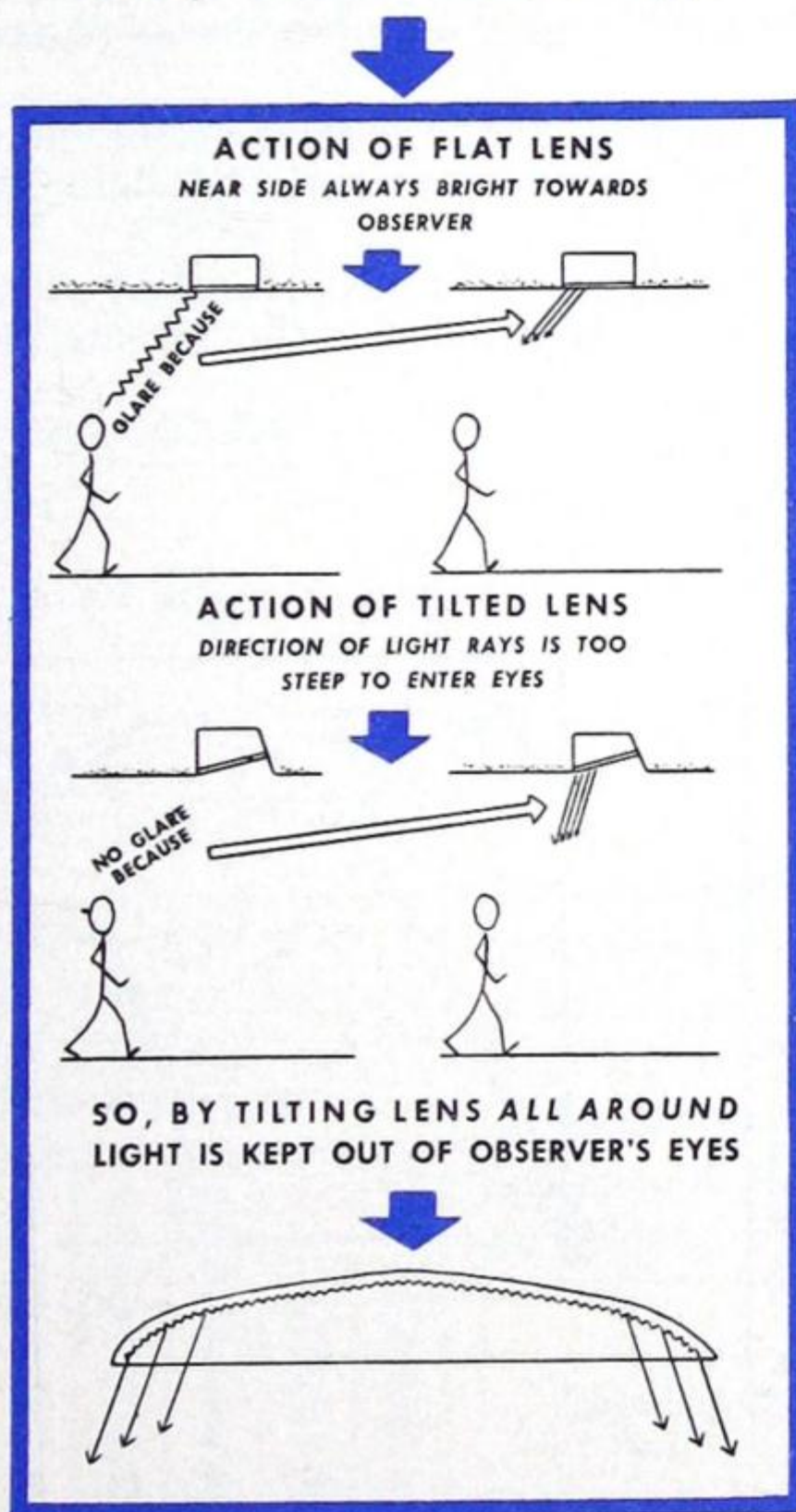

Why it is More Efficient

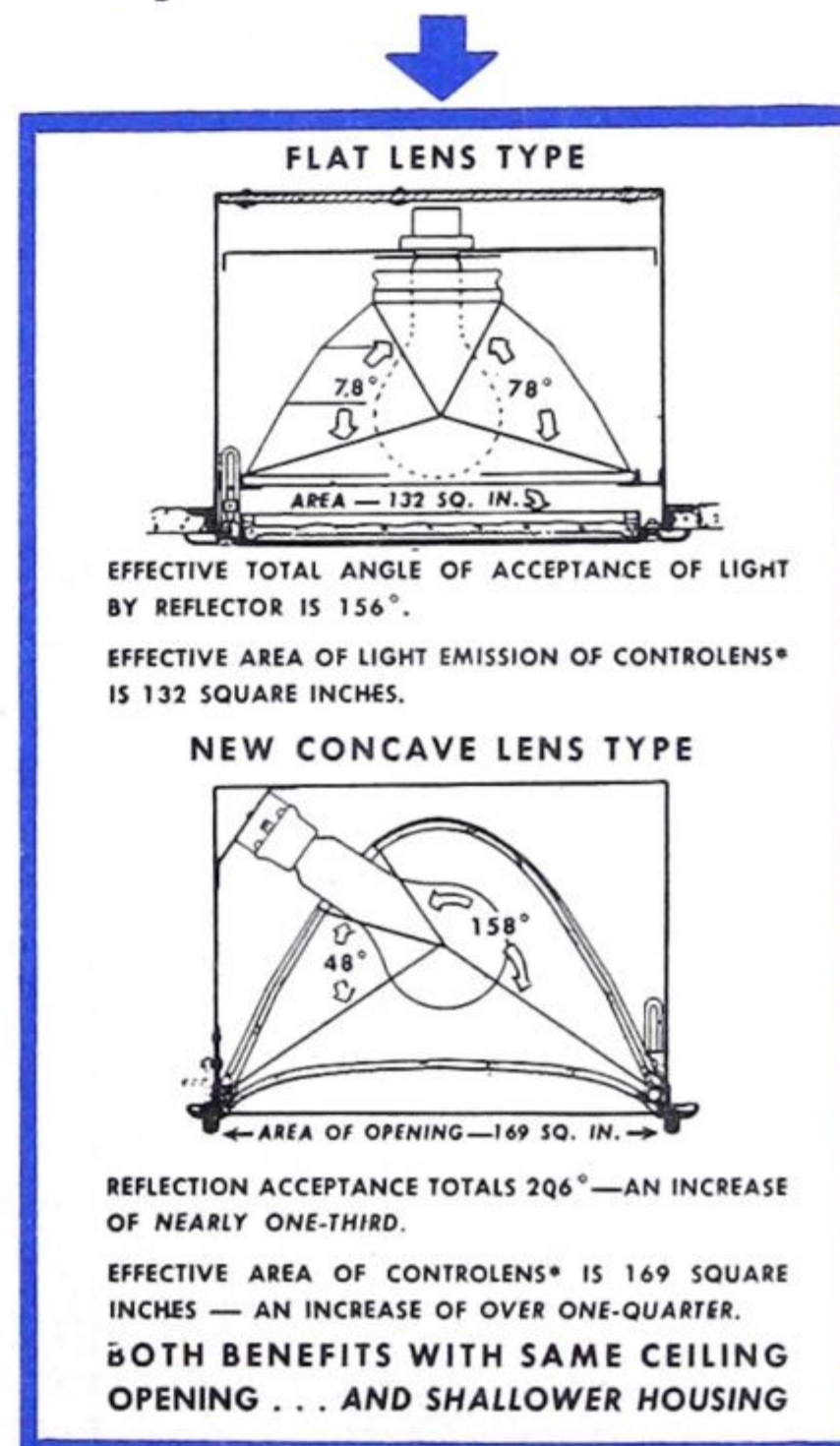

No. F-1570 is the Ideal Equipment for Lighting Classrooms, Offices and other Commercial and Institutional Interiors.

**For Complete Catalogue Information — See the Following Page
For Technical Advice Regarding All Your Lighting Problems —**

Consult Your Local Northern Electric Office



ENCLOSED RECESSED UNITS

Holophane In-Bilt Flush Units With Prismatic Glassware

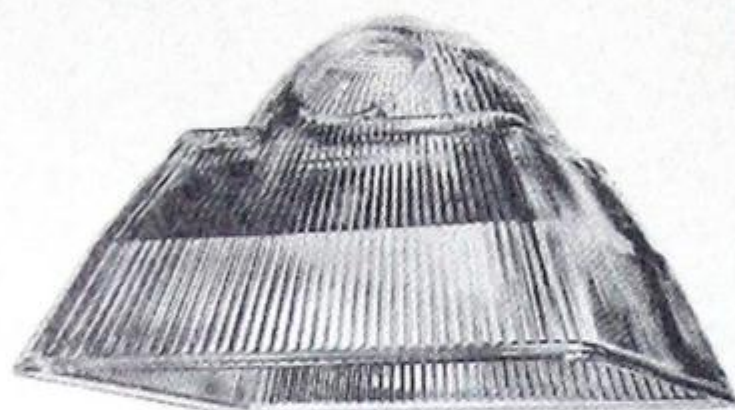

The square reflector has a dome shaped top section in which the opening for the side entrance of the lamp is placed. The overall depth of the luminaire is therefore reduced since the lamp is mounted on its side. The reflector is located as close as possible to the lens; as a result, a minimum of light is lost in the gap between lens and reflector.

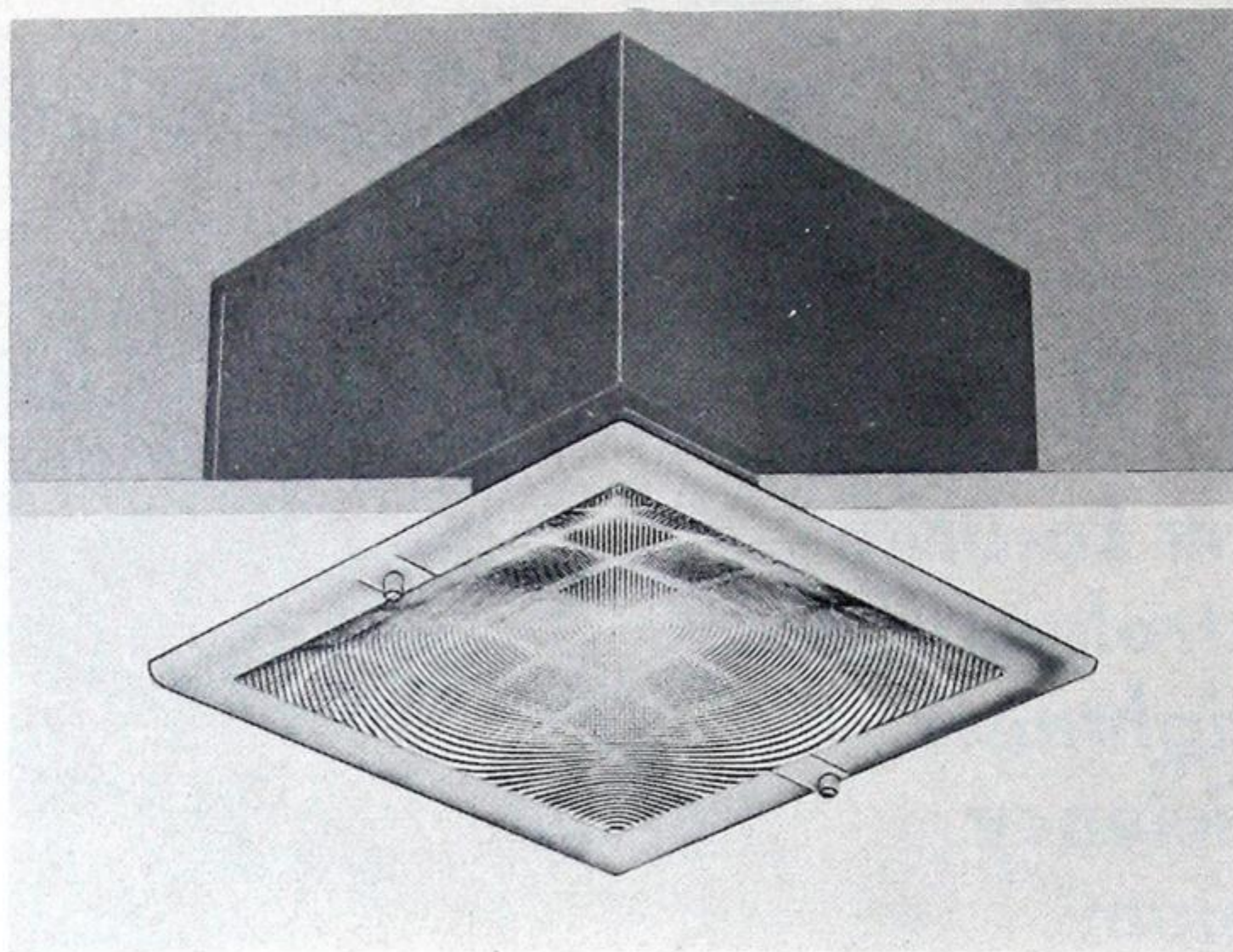

F-1570

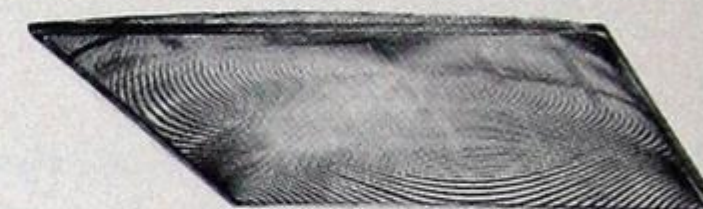

The concave CONTROLLEN is a pioneering development in lens design. The construction of the lens is also functional. Its shape, as an integral part of the "optical train", facilitates better transmission of both direct and reflected light resulting in high output. The near side of the lens recedes from the observer's view therefore resulting in uniform low brightness over the entire surface of the CONTROLLEN.

The No. F-1570 is designed to provide general lighting wherever uniform illumination of the working area is required. This unit is especially suitable for use in stores, offices, display rooms, studios, banks, schools and hospitals. The low brightness and outstanding efficiency of the F-1570 make it the most comfortable and modern of the In-Bilt lighting systems.

The intensive symmetric light distribution of the F-1570 is achieved through the optical system consisting of a square crystal glass reflector and a Lo-Brite prismatic control lens with concave contour. This distribution allows for higher illumination levels and closer spacing ratios for uniformity on the working plane.

The larger Control lens and narrower trim combine to produce a new achievement conforming to the highest architectural standards in appearance and design. The greater overall luminous area results in unusual efficiency, leads to accurate control of light and exceptionally low brightness. The dirt resistant construction of the housing assures low depreciation.

The optical elements are assembled in an 18 gauge steel housing approximately 13 5/16" square and 10" deep, finished white enamel inside and grey baked enamel outside. The 16 gauge pearl grey face plate containing the control lens is fastened to the housing by two concealed drop hinges and two knurled thumb nuts.

AVERAGE BRIGHTNESS DATA		
Vertical Angle	Foot-lamberts	
60°	860	
65°	740	
70°	650	
75°	570	
80°	480	
85°	320	
ZONAL EFFICIENCY		
0°—60°	60°—90°	0°—90°
61.6%	3.1%	64.7%

SPACING 1xMH		EFF 64.7%	
M.F.	INTENSIVE	0% ↑	
G.90	F-1570	64.7% ↓	
M.85	DISTRIBUTION		
P.80			
CEILING	75%	50%	
WALLS	50%	30%	10%
	50%	30%	10%
ROOM INDEX	COEFFICIENT OF UTILISATION		
J	.37	.35	.34
I	.44	.43	.42
H	.47	.47	.46
G	.50	.50	.49
F	.53	.52	.50
E	.55	.54	.54
D	.59	.56	.56
C	.59	.58	.56
B	.60	.59	.58
A	.61	.60	.58

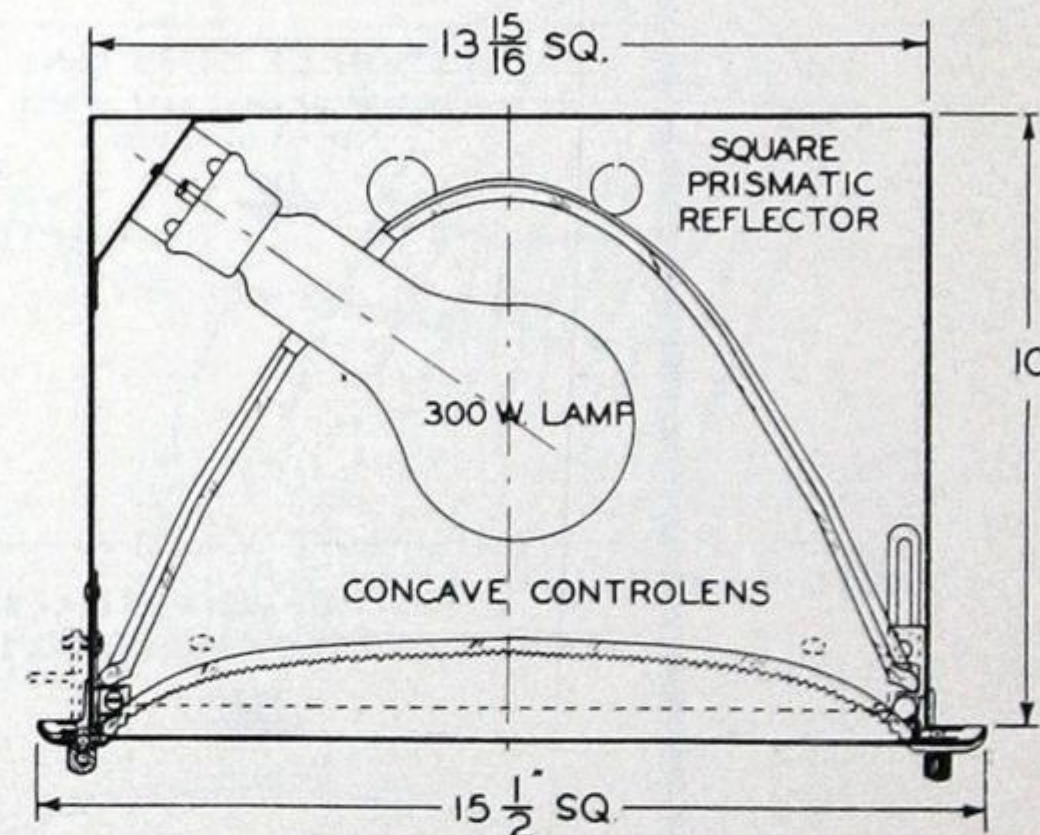

Cat. No.	Lamp Wattage	Dimensions in Inches						
		Roughing Box			Face Plate		Framed Opening	
		Length	Width	Depth	Length	Width	Length	Width
F-1570	300*	13 5/16	13 5/16	10	15 1/2	15 1/2	14 1/8**	14 1/8**

*Medium base—6" light centre clear lamp recommended.
 **For existing ceiling, minimum ceiling opening of 14 1/2" is required to accommodate No. 0264 Plaster Ring. Plaster Ring No. 0264 supplied separately.



ENCLOSED RECESSED UNITS

Holophane In-Bilt Flush Units With Prismatic Glassware

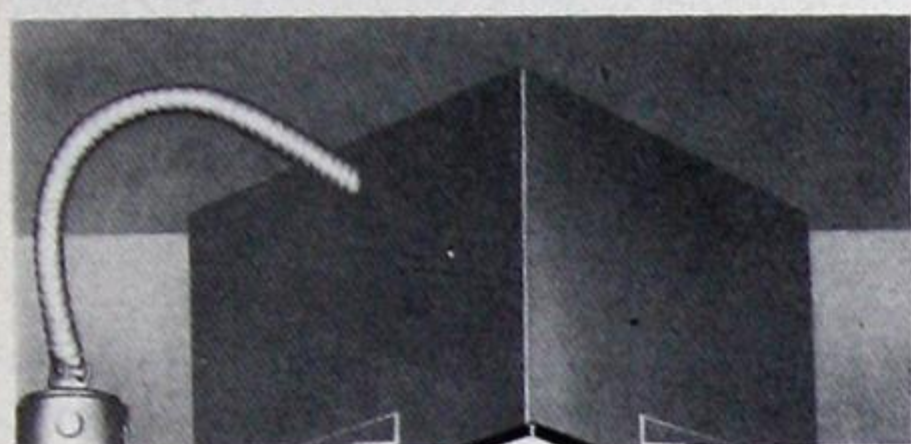

TYPICAL SINGLE UNIT

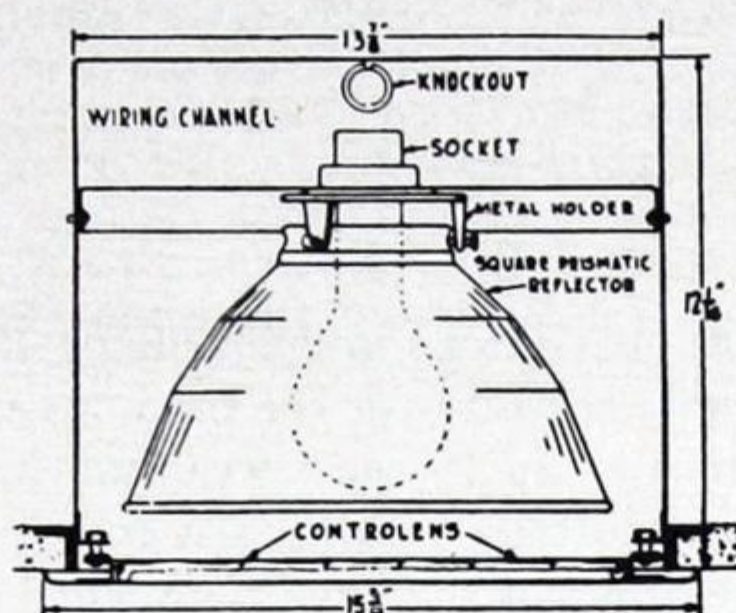

SECTIONAL VIEW THROUGH WIDTH—MULTIPLE UNITS

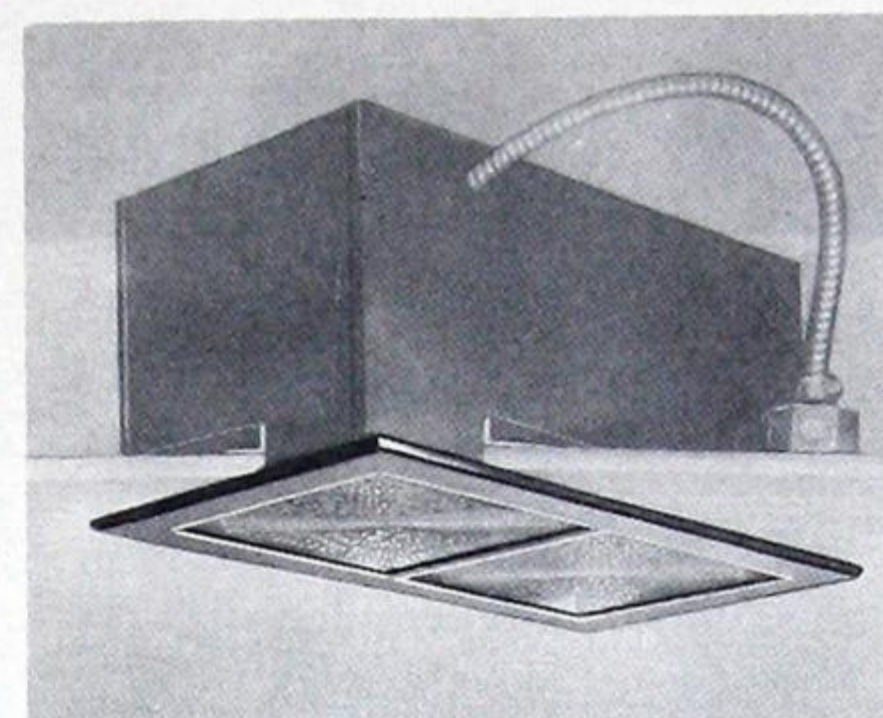

TYPICAL MULTIPLE UNIT

SPACING 1.25xMH		EFF 53.0%	
M.F. G.90 M.85 P.80	INTENSIVE F-1774 DISTRIBUTION	0% ↑ 53.0% ↓	
CEILING	75%	50%	
WALLS	50% 30% 10%	50% 30% 10%	
ROOM INDEX	COEFFICIENT OF UTILISATION		
J	.30	.28	.27
I	.35	.34	.34
H	.38	.37	.37
G	.41	.40	.39
F	.43	.42	.41
E	.44	.44	.44
D	.47	.45	.45
C	.48	.47	.47
B	.48	.47	.47
A	.49	.48	.47

These units, being built-in, become an integral part of the building interior; they blend with most architectural designs. In most cases they are used in a "general" lighting layout; lighting is evenly spread over the room area when the units are uniformly spaced. This type of lighting is used in stores, offices, banks, schools, churches, hospitals, studios, public buildings, etc.

At any normal angle of view the lighted fixture causes no discomfort because the amount of light at high angles is negligible. Lighted or unlighted the appearance of the unit flushed with the ceiling is pleasing. The light is the same colour as that emitted by the lamp since clear prismatic glass does not distort the colour of the light transmitted by it. Performance is high between cleaning intervals because of the dirt-resisting construction of the unit and its location up in the ceiling. The prismatic crystal glass suffers no permanent depreciation.

Catalogue No.*	Lamps**	Dimensions						
		Roughing Box			Face Plate		Plaster Opening	
		Length	Width	Depth	Length	Width	Length	Width
F-1774	300W	13 7/8"	13 7/8"	10 7/8"	15 3/8"	15 3/8"	14 3/8"	14 3/8"
F-1774-2	2 x 300W	25 3/4"	13 7/8"	12 1/16"	27 3/8"	15 3/8"	26"	14 1/8"
F-1774-3	3 x 300W	37 7/8"	13 7/8"	12 1/16"	39 3/8"	15 3/8"	38 1/8"	14 1/8"
F-1774-4S	4 x 300W	26"	26"	12 1/16"	26 7/8"	26 7/8"	26 1/4"	26 1/4"

*Also available with removable top for servicing from above. To specify add suffix "TS" to Catalogue No.

**Medium Base—6" Light Center Lamp. Plaster rings not supplied for this type of unit.

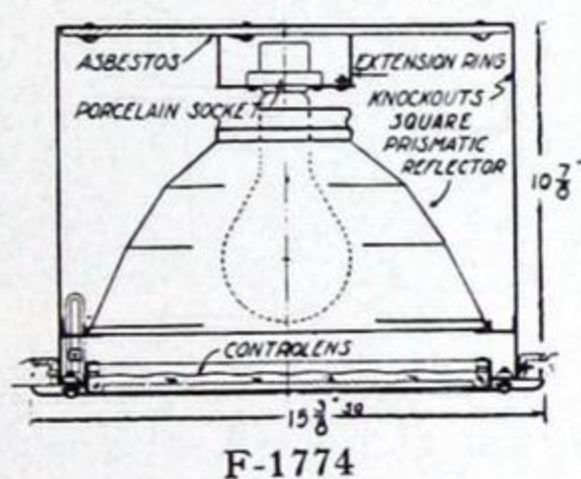

F-1774

SPACING .75xMH		EFF 41.8%	
M.F. G.90 M.85 P.80	FOCUSING F-1765 DISTRIBUTION	0% ↑ 41.8% ↓	
CEILING	75%	50%	
WALLS	50% 30% 10%	50% 30% 10%	
ROOM INDEX	COEFFICIENT OF UTILISATION		
J	.24	.23	.22
I	.28	.28	.27
H	.31	.30	.30
G	.33	.32	.32
F	.34	.33	.33
E	.36	.35	.35
D	.38	.36	.37
C	.38	.38	.37
B	.39	.38	.37
A	.39	.38	.38

These units are used for two types of lighting: General Lighting: in narrow high ceilinged interiors as may occur in some stores, churches, banks, gymnasiums, museums.

Local Lighting: where the light is focussed on people, objects, work areas, displays. Where focusing beams are used to supplement existing installations by combination with the "general" system in use. A variety of light patterns are possible with this unit. Data shown, however, is the standard setting for units listed here. The change in light distribution results from changes in focus (distance of lamp filament from Control lens) and lamp offset (distance of lamp filament to right or left of centerline of Control lens). Some light is emitted all the way up to the horizontal but the quantity at the high angles (60°-90°) is low, resulting in a comfortable appearance at normal angles of view. The appearance of the unit when installed in the ceiling is pleasing, both when lighted and unlighted. For technical advice regarding the most suitable light distribution for your particular problem—CONSULT YOUR LOCAL NORTHERN ELECTRIC OFFICE.

Catalogue No.*	Lamps**	Dimensions						
		Roughing Box			Face Plate		Plaster Opening	
		Length	Width	Depth	Length	Width	Length	Width
F-1765	300W	13 7/8"	13 7/8"	10 7/8" †	15 3/8"	15 3/8"	14 3/8"	14 3/8"
F-1765-2	2 x 300W	25 3/4"	13 7/8"	12 1/16"	27 3/8"	15 3/8"	26"	14 1/8"
F-1765-3	3 x 300W	37 7/8"	13 7/8"	12 1/16"	39 3/8"	15 3/8"	38 1/8"	14 1/8"
F-1765-4S	4 x 300W	26"	26"	12 1/16"	26 7/8"	26 7/8"	26 1/4"	26 1/4"

*Also available with removable top for servicing from above. To specify add suffix "TS" to Catalogue No.

**Medium Base—6" Light Center Lamp. Plaster rings not supplied with this type of unit.

†Depth necessary for standard distribution. Otherwise F-1765 is 12 1/16" deep.

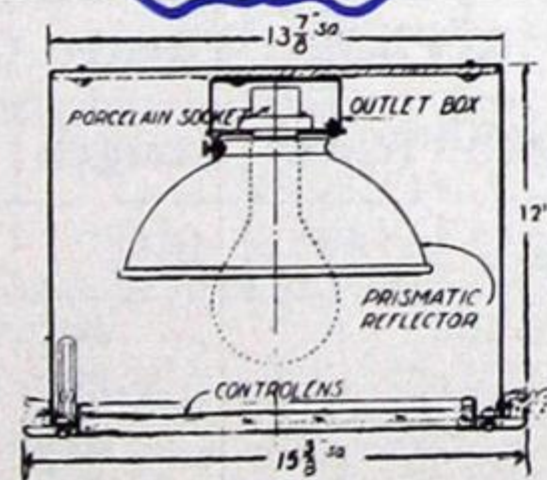

F-1765



ENCLOSED RECESSED UNITS

Holophane In-Bilt Flush Units With Prismatic Glassware

SPACING 1.25xMH		EFF 51.4%	
M.F.	INTENSIVE	0% ↑	
G.90	F-1748	51.4% ↓	
M.85	DISTRIBUTION		
P.80			
CEILING	75%	50%	
WALLS	50% 30% 10%	50% 30% 10%	
ROOM INDEX	COEFFICIENT OF UTILISATION		
J	.30	.28	.27
I	.35	.34	.34
H	.38	.37	.37
G	.41	.40	.39
F	.43	.42	.41
E	.44	.44	.43
D	.47	.45	.45
C	.48	.47	.45
B	.48	.47	.46
A	.49	.48	.47

The 1748 Series provides an intensive light distribution and is used for "general" lighting layouts. Lighting is evenly spread over the room area when the units are uniformly spaced. Some light is emitted all the way up to the horizontal, but the quantity at the high angles (60°-90°) is low, resulting in a comfortable appearance at normal angles of view. The appearance of the unit when installed in the ceiling is pleasing, both when lighted and unlighted. The emitted light is the same colour as that of the lamp as crystal glass does not change the colour of the light. Maintenance is at a minimum because the dirt-resisting construction of the unit and its normal location permits longer intervals between cleaning. Prismatic crystal glass suffers no permanent depreciation.

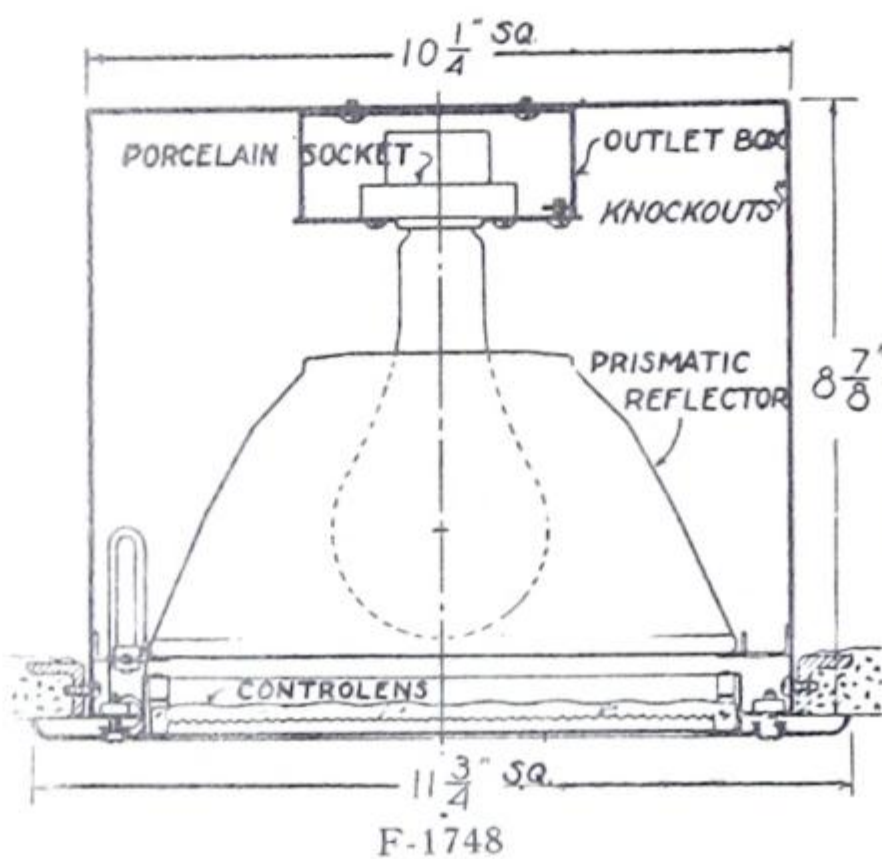

Catalogue No.	Lamp	Approx. Dimensions						
		Roughing Box			Face Plate		Plaster Opening	
		Length	Width	Depth	Length	Width	Length	Width
F-1748	150W	10 1/4"	10 1/4"	8 7/8"	11 3/4"	11 3/4"	10 3/4"	10 3/4"

SPACING .9xMH		EFF 44.4%	
M.F.	FOCUSING	0% ↑	
G.90	F-1739	44.4% ↓	
M.85	DISTRIBUTION		
P.80			
CEILING	75%	50%	
WALLS	50% 30% 10%	50% 30% 10%	
ROOM INDEX	COEFFICIENT OF UTILISATION		
J	.25	.24	.23
I	.30	.30	.29
H	.32	.31	.31
G	.35	.34	.34
F	.36	.35	.35
E	.38	.37	.37
D	.40	.38	.38
C	.40	.39	.39
B	.41	.40	.40
A	.41	.41	.40

The F-1739 Series provides a focusing light distribution used either for General Lighting or Local Lighting to emphasize certain areas, or displays. A variety of light patterns are possible with this unit. Data shown, however, is the standard setting for units listed here. The change in light distribution results from changes in focus (distance of lamp filament from Controlens) and lamp offset (distance of lamp filament to right or left of centerline of Controlens). Some light is emitted all the way up to the horizontal but the quantity at the high angles (60°-90°) is low, resulting in a comfortable appearance at normal angles of view. The appearance of the unit when installed in the ceiling is pleasing both when lighted and unlighted. For technical advice regarding the most suitable light distribution for your particular problem — **CONSULT YOUR LOCAL NORTHERN ELECTRIC OFFICE.**

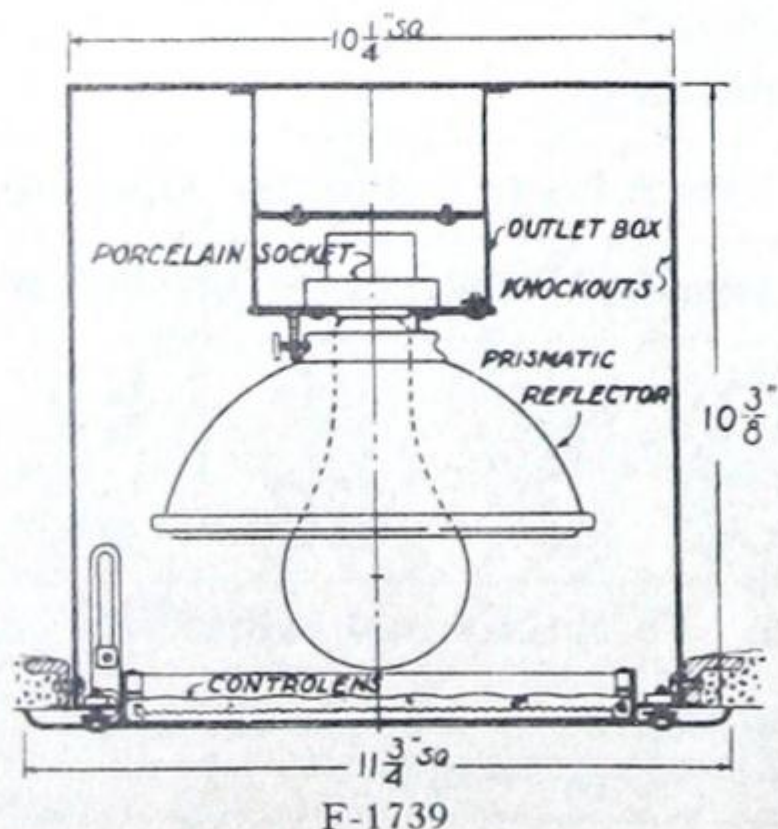

Catalogue No.	Lamp	Approx. Dimensions						
		Roughing Box			Face Plate		Plaster Opening	
		Length	Width	Depth	Length	Width	Length	Width
F-1739	150W	10 1/4"	10 1/4"	10 3/8"	11 3/4"	11 3/4"	10 3/4"	10 3/4"



ENCLOSED RECESSED UNITS

Holophane In-Bilt Flush Units With Prismatic Glassware

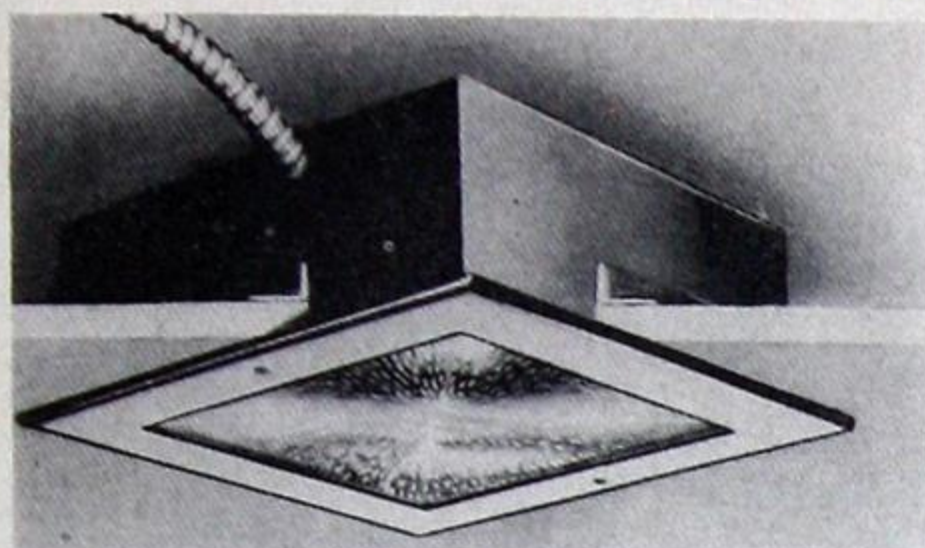

SD-739-100, 150

This unit is ideally suited for locations where the ceiling depth is restricted. The appearance of the unit when installed in the ceiling is pleasing, both when lighted and unlighted. Maintenance is at a minimum because the dirt-resisting construction of the unit and its normal location permits longer intervals between cleaning. Prismatic crystal glass suffers no permanent depreciation.

SPACING .75xMH		EFF 35.4%	
M.F.	INTENSIVE		
G.90	SD 739-100		0% ↑
M.85	SD 739-150		35.4% ↓
P.80	DISTRIBUTION		
CEILING	75%		50%
WALLS	50%	30%	10%
ROOM INDEX	COEFFICIENT OF UTILISATION		
J	.20	.19	.18
I	.24	.24	.23
H	.26	.25	.25
G	.28	.27	.27
F	.29	.28	.28
E	.30	.30	.30
D	.32	.30	.31
C	.32	.31	.32
B	.33	.32	.32
A	.33	.33	.32

Catalogue No.	Lamp	Dimensions						
		Roughing Box			Face Plate		Plaster Opening	
		Length	Width	Depth	Length	Width	Length	Width
SD-739-100	100W	10 1/2"	10 1/2"	4 1/4"	11 3/4"	11 3/4"	10 3/4"	10 3/4"
SD-739-150	150W	10 1/2"	10 1/2"	4 1/2"	11 3/4"	11 3/4"	10 3/4"	10 3/4"

Plaster ring not supplied with this type of unit.

Units For Lighting Vertical Surfaces

These units are made for Flush or Surface mounting. They are designed to light blackboards, bulletin boards, switchboard panels and similar vertical surfaces. Generally, the 796 type is used as separate units in intermittent runs, also for use with long blackboards.

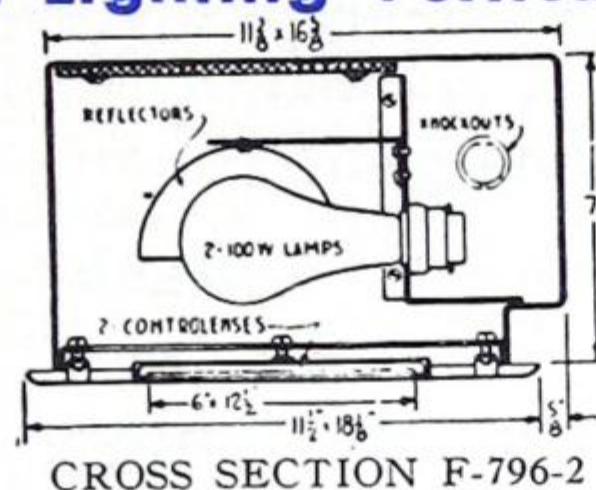

The requirement for lighting a vertical surface is to bend the light beam toward the surface and then spread it out along the wall. The light should be directed to the surface at a sharp angle so as to cut out "specular" reflection at normal viewing angles.

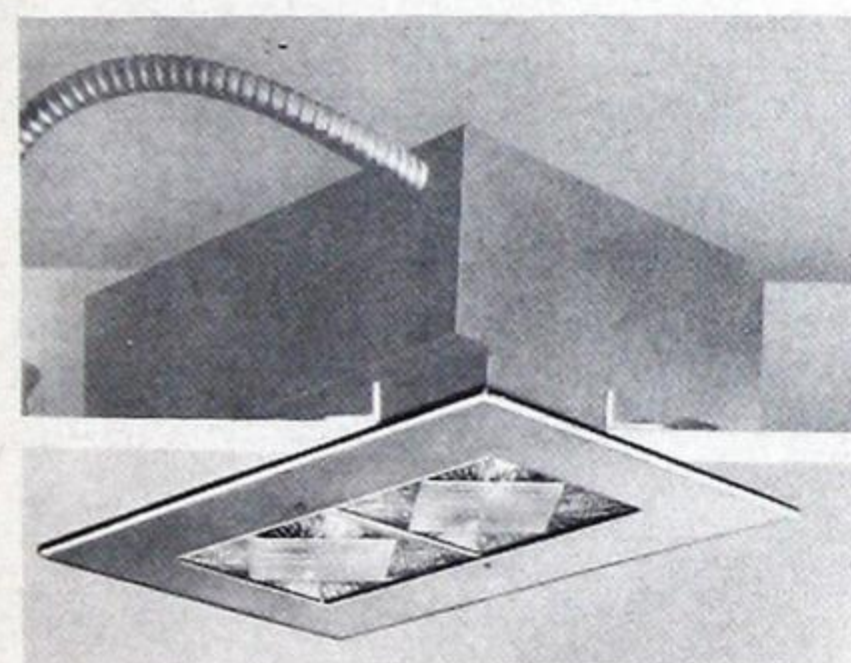

No. F-796-2 FLUSH TYPE

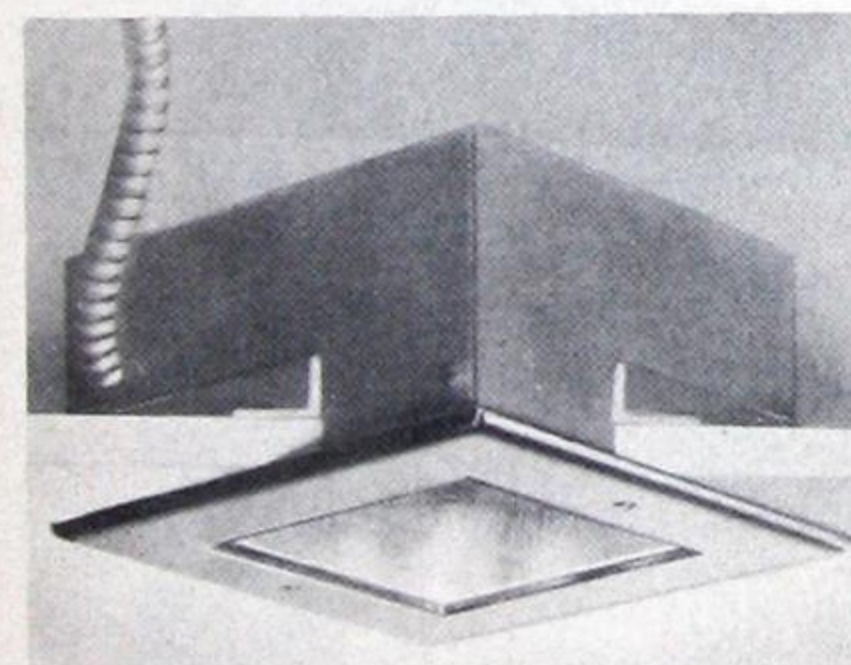

No. F-796 FLUSH TYPE

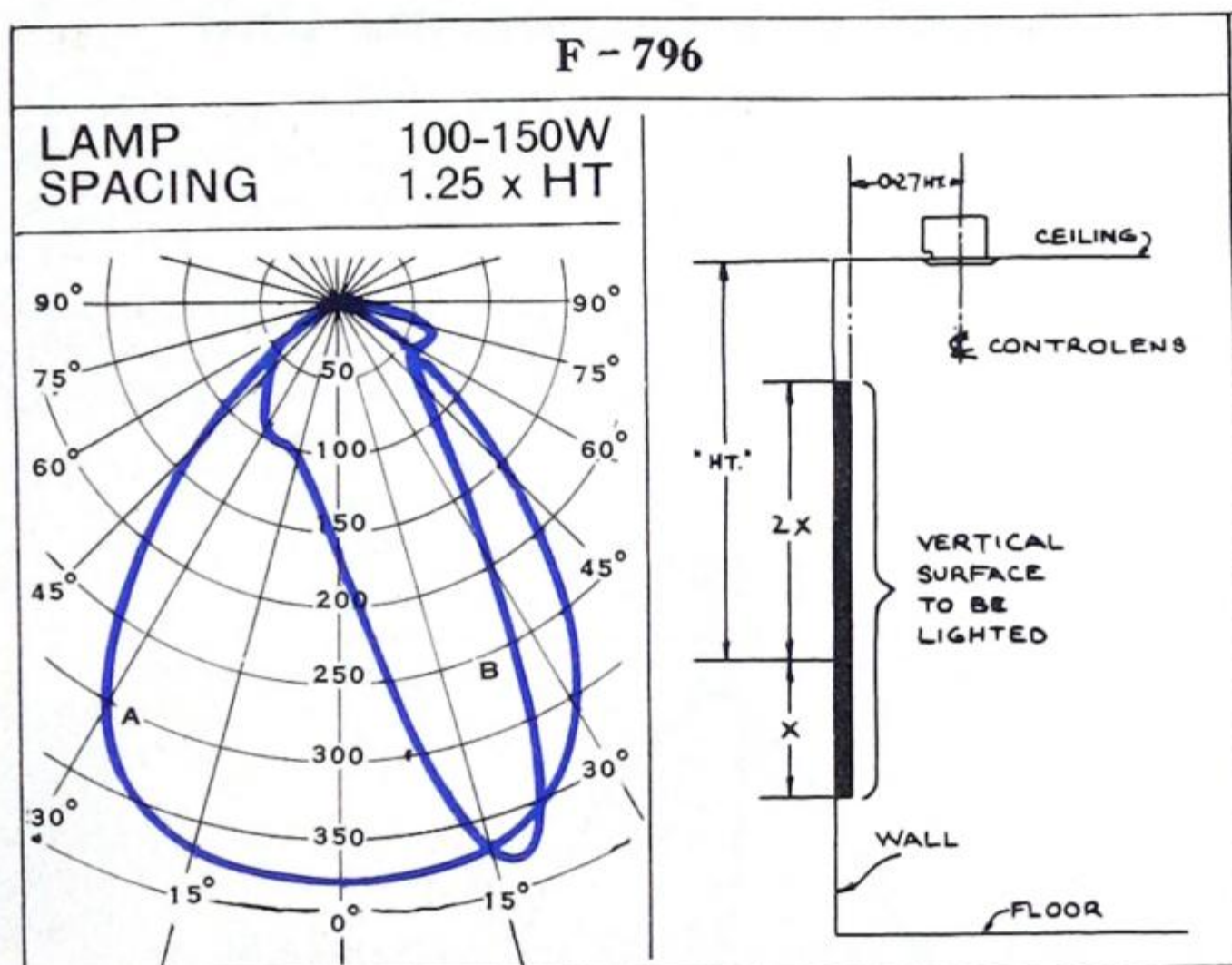

Left: A—Lateral Distribution along surface.
B—Vertical Distribution toward surface.
Right: Location Details for vertical surface lighting.

- Notes 1. Max. spacing along wall 1.25 x HT.
2. For surface mounted units subtract 5 7/8" to obtain true "HT".

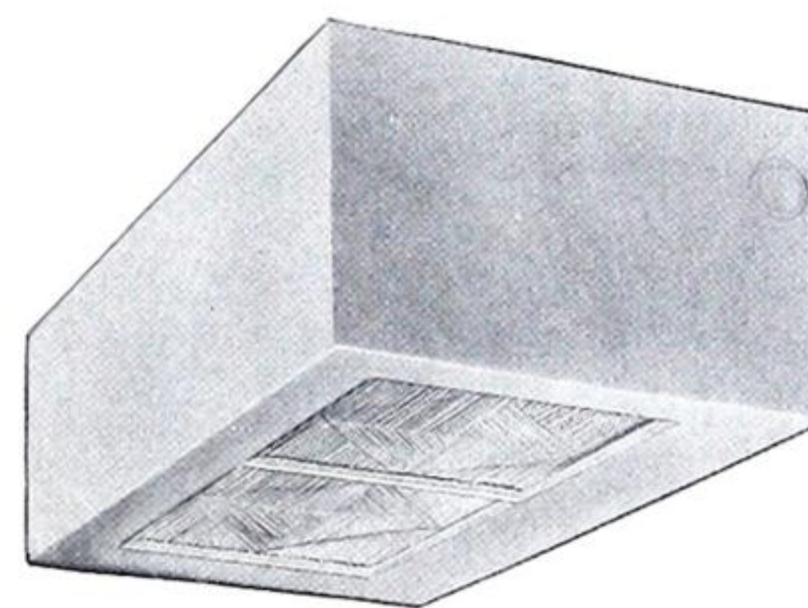

No. E-796-2 SURFACE TYPE

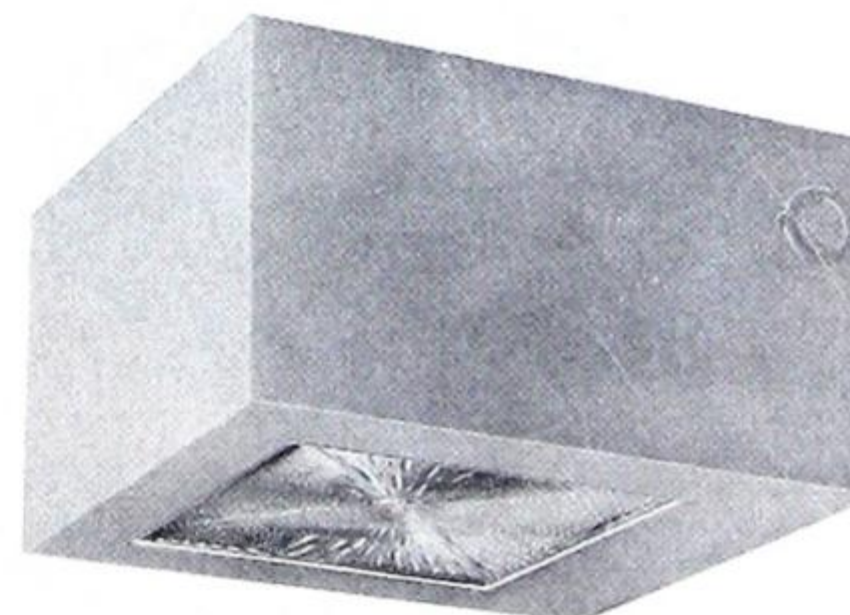

No. E-796 SURFACE TYPE

Catalogue No.	Lamp Watts	Dimensions						
		Roughing Box			Face Plate		Plaster Opening	
		Length	Width	Depth	Length	Width	Length	Width
F-796	100/150	9 3/8"	8"	6"	9 3/8"	9 3/8"	8 1/4"	8 1/4"
F-796-2	2x100/150	16 5/8"	11 3/8"	7"	18"	11 1/2"	16 7/8"	10 1/4"
E-796	100/150	8 3/8"	9 1/2"	5 7/16"	—	—	—	—
E-796-2	2x100/150	15"	9 1/2"	5 7/8"	—	—	—	—

COMMERCIAL LIGHTING
INCANDESCENT



ENCLOSED RECESSED UNITS

Holophane In-Bilt Units With Prismatic Glassware

Modelite (R) Unit

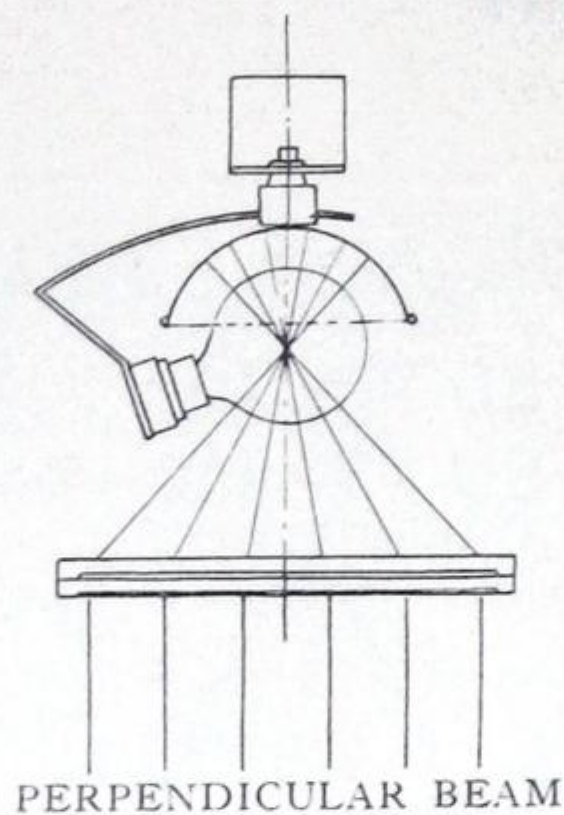

PERPENDICULAR BEAM

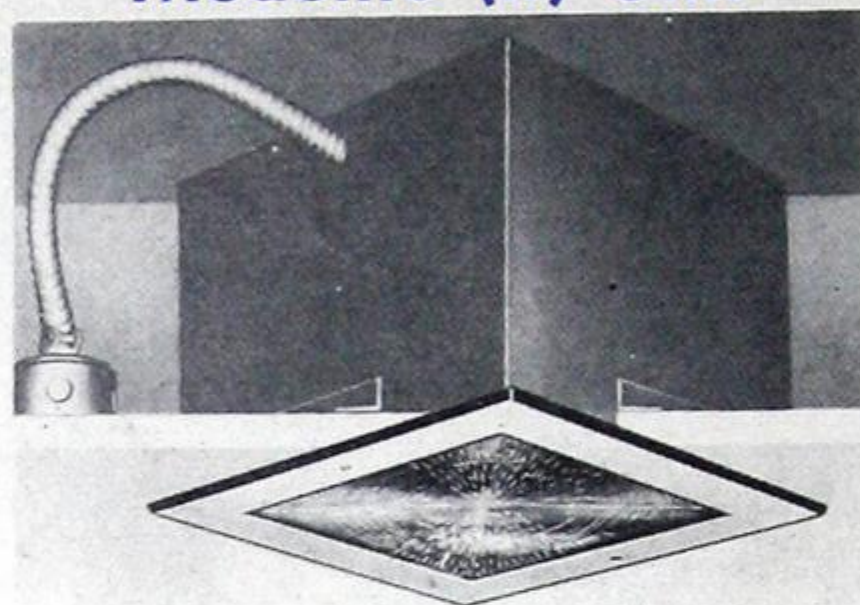

No. F-1778-M

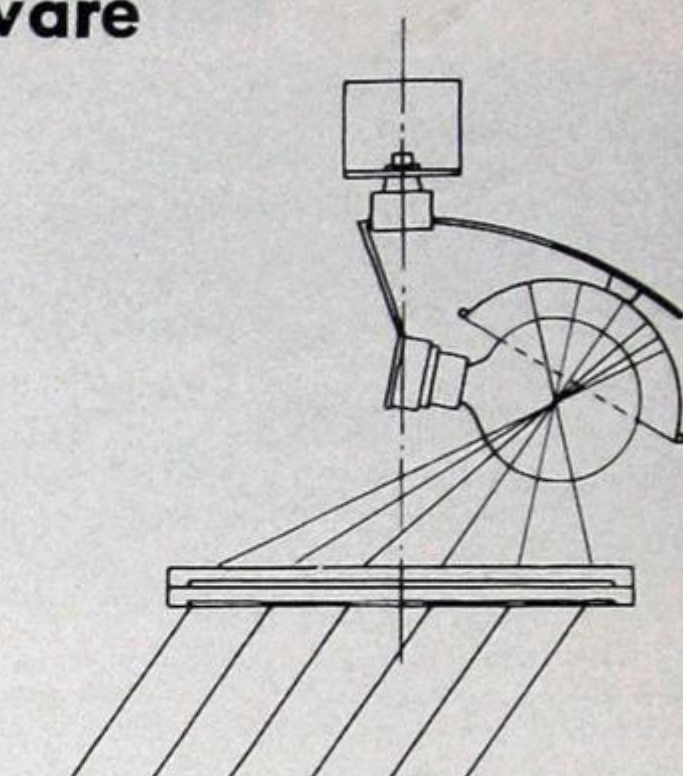

BEAM 35° TO PERPENDICULAR

The application of spot lighting to feature items of merchandise has become standard practice with display managers. Until the advent of the Modelite, this consisted of attaching spot lights to the ceilings or columns—a generally unsightly procedure.

The Modelite is a recessed Controlens lighting unit which makes it possible, for the first time, to spot light or "accent" merchandise display from a light source which is an integral part of the general lighting system. The result is unique in that the display is flooded with light without any distracting brightness of the source from which it comes.

The sketches above show the mechanical features of modeling or "accent" light assembly. (Left): Relation of principal elements of optical train to produce perpendicular parallel beams. (Right): Relation of principal elements of optical train to produce parallel beam at 35 degrees from the lens perpendicular.

Catalogue No.	Lamp	Dimensions						
		Roughing Box			Face Plate		Plaster Opening	
		Length	Width	Depth	Length	Width	Length	Width
F-1778-M	250W G30	14 ⁵ / ₈ "	14 ⁵ / ₈ "	13 ⁷ / ₈ "	15 ³ / ₈ "	15 ³ / ₈ "	14 ⁷ / ₈ "	14 ⁷ / ₈ "

Holophane Counterlite Unit

The name Counterlite indicates the chief application of this precision lighting unit—the lighting of store counters. Centered over the counter edge, it projects an oval pattern of light—narrow across and spread along the counter. In this way, the majority of the light is concentrated on the display—resulting in higher illumination and greater attraction. Spill light takes care of traffic aisles and stock shelves.

These units are available for either recessed or surface mounting. The optical parts—a compound Controlens and a polished aluminum reflector—are supported by a No. 16 gauge steel box. In the case of the surface type, the standard external finish is silver-tone aluminum which serves as a prime coat if the unit is to be painted in with the ceiling. For use with either 200 or 300 watt medium base lamp.

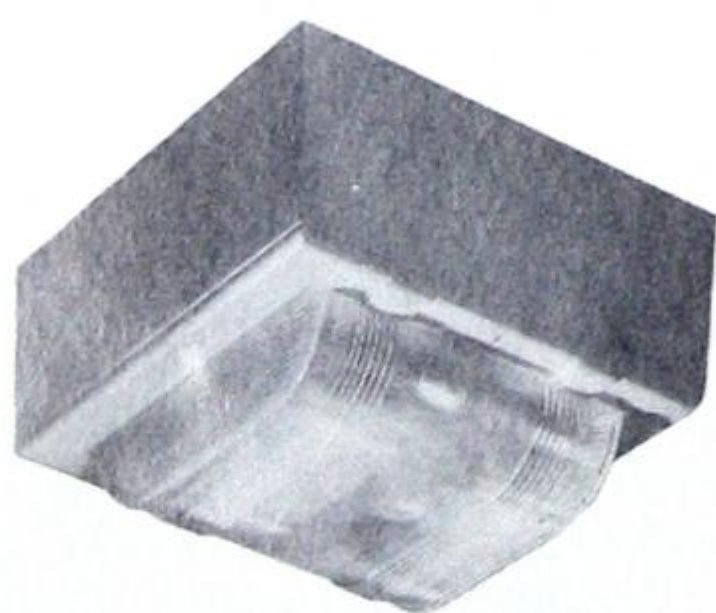

No. E-1814 SURFACE TYPE

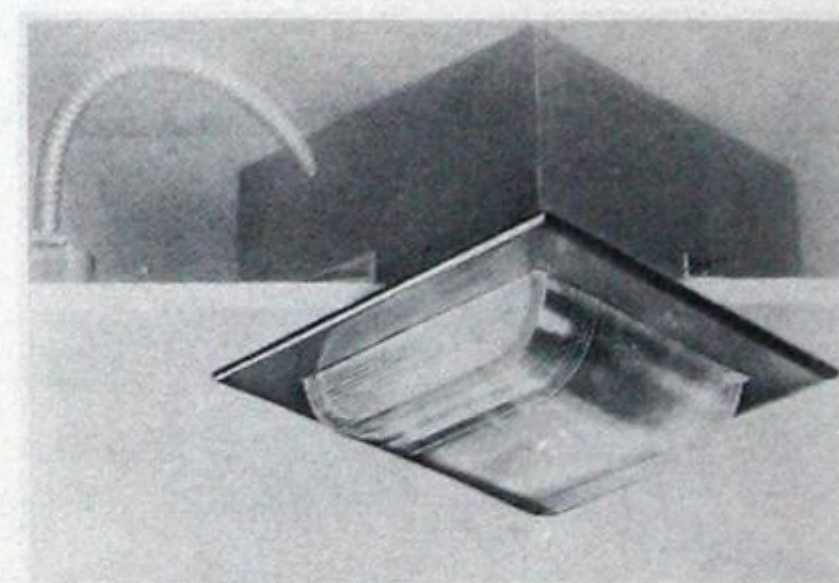
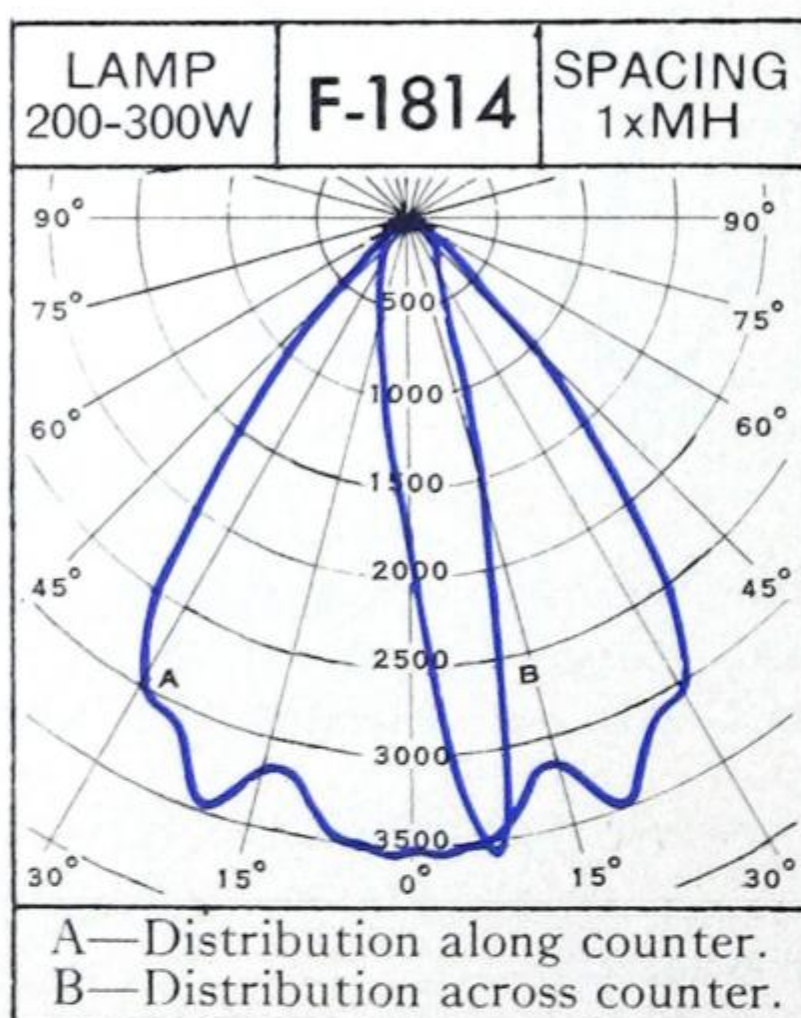

No. F-1814 RECESSED TYPE

Catalogue No.	Lamp	Dimensions						
		Roughing Box			Face Plate		Plaster Opening	
		Length	Width	Depth	Length	Width	Length	Width
E-1814	200-300*	13 ³ / ₄ "	13 ³ / ₄ "	7"	15 ³ / ₈ "	15 ³ / ₈ "	14"	14"
F-1814	200-300*	14 ¹ / ₂ "	14 ¹ / ₂ "	8 ³ / ₄ "	—	—	—	—

*Medium Base—6" Light Center Lamp—Plaster Ring not supplied with this type of unit.

(R) The Holophane Co. Ltd.



OPEN TYPE RECESSED UNITS

Holophane In-Bilt Flush Units With Prismatic Glassware

These units are designed for installation without a metal housing, which results in considerable over-all economies. Efficient lighting performance between cleaning intervals is maintained because of the enclosed construction.

The R-2772 and the R-2773 are designed for tile or block ceilings and being 12" square will exactly replace a single tile. The R-2772 will fit any standard block construction, such as Celotex, and may be attached directly to the ceiling framing by means of a metal frame supplied with the unit. The R-2773 was especially designed for attachment to the "T" bar construction used with Johns-Manville Sanacoustic tile ceilings.

SPACING 1.25xMH		EFF 44.6%	
M.F.	INTENSIVE		
G.90	R-2772		0% ↑
M.85	R-2773		44.6% ↓
P.80	DISTRIBUTION		
CEILING	75%		50%
WALLS	50%	30%	10%
ROOM INDEX	COEFFICIENT OF UTILISATION		
J	.25	.24	.24
I	.30	.29	.29
H	.33	.32	.32
G	.35	.34	.33
F	.37	.36	.35
E	.38	.37	.36
D	.41	.39	.37
C	.41	.40	.39
B	.41	.41	.40
A	.42	.41	.40

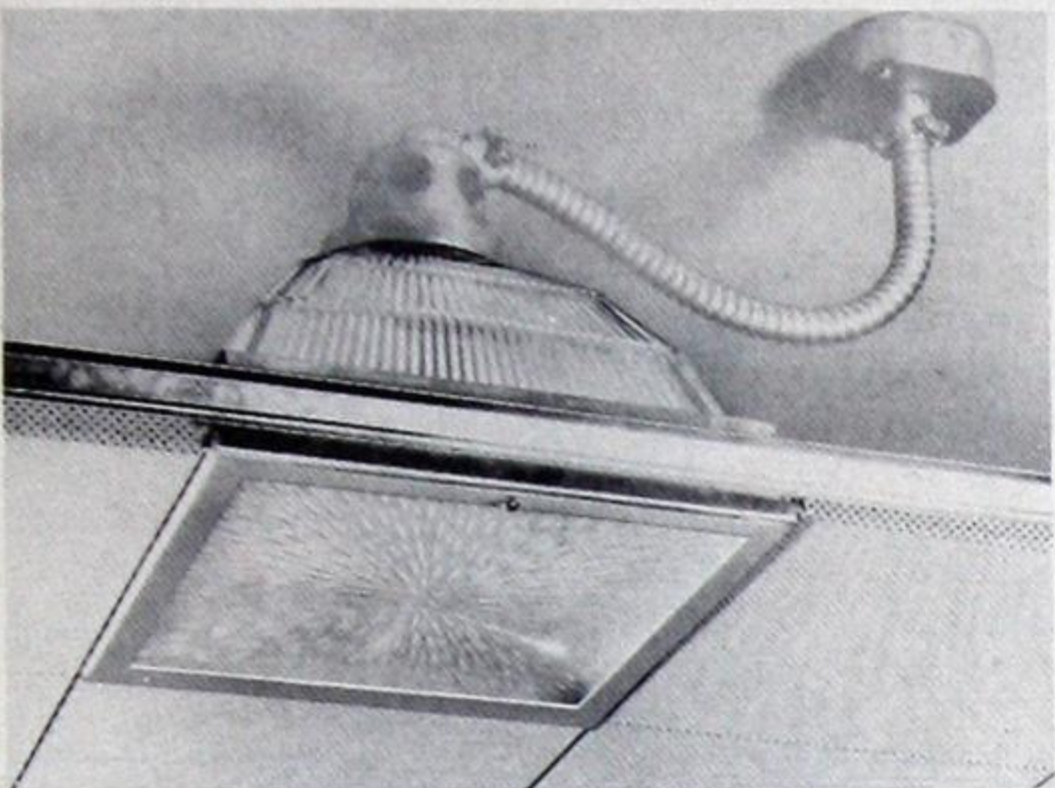

No. R-2772

Catalogue No.	Lamp Watts*	Dimensions		Weight
		Depth	Face Plate	
R-2772	200-300	12 1/8"	12" Sq.	14 lbs.
R-2773	200-300	12 1/8"	12" Sq.	13 lbs.

*Medium Base—6" light center lamp.

Round "No-Box" Unit

R-1894: This flush unit, with round Controlens, is used for general lighting applications. It has been designed for installation without metal housing, which results in considerable over-all economies. Its round contour makes it suitable for certain architectural requirements. High lighting performance between cleaning intervals is assured because of the enclosed construction.

SPACING 1.25xMH		EFF 54.0%	
M.F.	INTENSIVE		
G.90	R-1894		0% ↑
M.85			54.0% ↓
P.80	DISTRIBUTION		
CEILING	75%		50%
WALLS	50%	30%	10%
ROOM INDEX	COEFFICIENT OF UTILISATION		
J	.31	.29	.28
I	.37	.36	.35
H	.40	.39	.38
G	.40	.42	.41
F	.44	.43	.42
E	.46	.45	.45
D	.49	.47	.47
C	.50	.49	.48
B	.50	.49	.48
A	.51	.50	.49

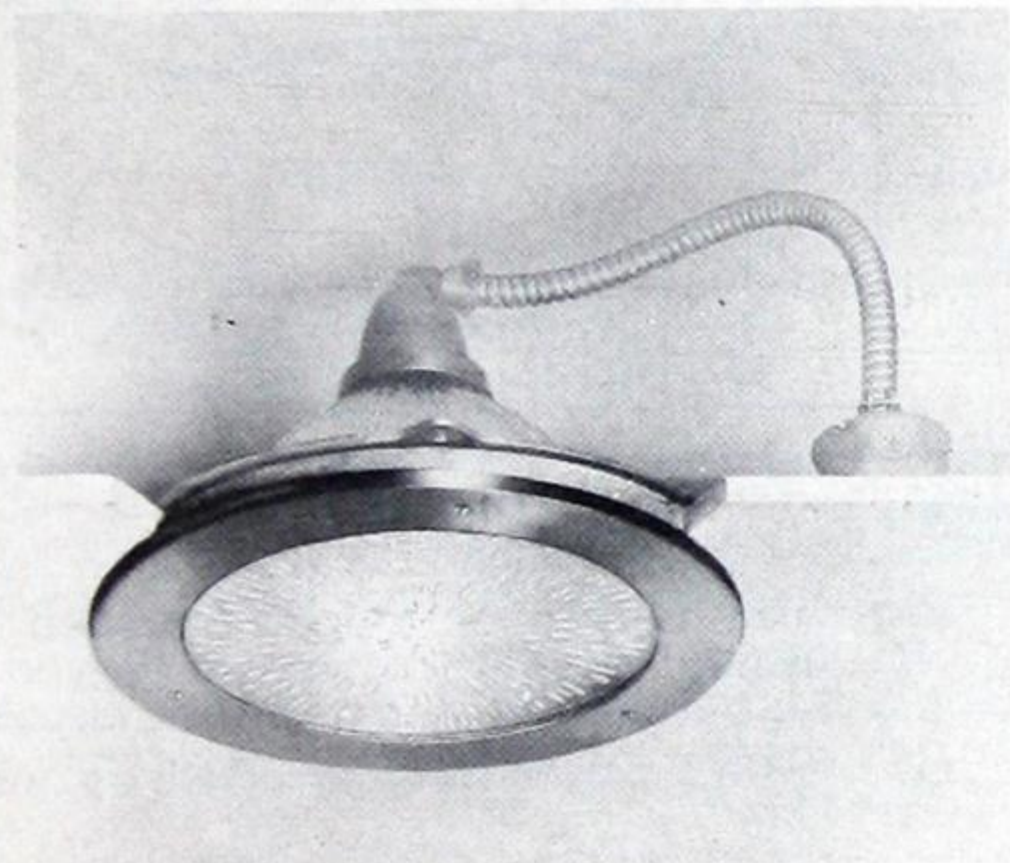

No. R-1894

Catalogue No.	Lamp Watts	Dimensions		Termination
		Depth	Face Plate Diam.	
R-1894	200-300*	11 3/4"	15 1/2"	Tapped for 1/2" pipe

*Medium Base—6" light center lamp.

Holophane Recessed Night Light

For night lighting in hospital sickrooms, corridors, theatre aisles, bedrooms in homes, hotels, clubs, nurseries, and similar locations. This unit throws an even sheet of low intensity light over the lower part of the room or corridor without glare. The light cuts off abruptly at knee height. When concealed by placement in the wall beneath the bed, the floor is lighted uniformly, revealing the room for night inspection without waking the patient. Switches may be located outside the door.

For corridor lighting, the height of the top of the unit may be determined by dividing the corridor width by 4.3.

The shallow depth of the unit (3") allows installations in the thinnest standard structural partitions. This shallowness is accomplished through use of the slender T-6 1/2, 25 watt tubular lamps.

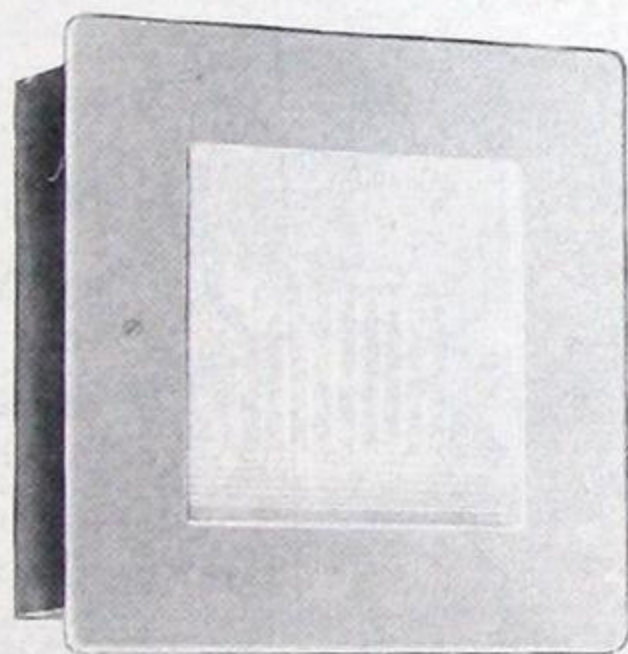

No. W-792

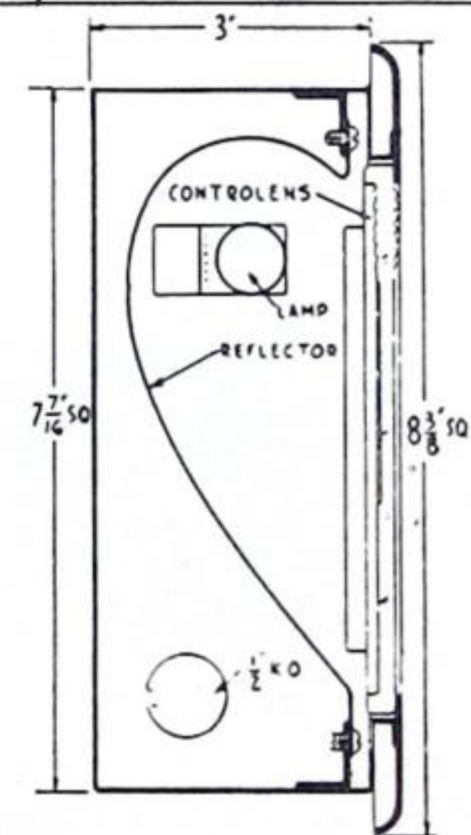

Catalogue No.	Lamp	Dimensions						
		Roughing Box			Face Plate		Plaster Opening	
		Length	Width	Depth	Length	Width	Length	Width
W-792	25W-T6 1/2	7 1/2"	7 1/2"	3"	8 3/8"	8 3/8"	7 3/4"	7 3/4"

Plaster ring not furnished.



PRISMATIC GLASSWARE UNITS

Holophane In-Bilt Flush Units



Nos. R-2460, R-2476

R-2460 and R-2470, having a symmetrical light distribution, are for general lighting. R-2472, asymmetric, is for corridor lighting. R-2476, asymmetric, is for stack lighting.

Application: No. R-2460 is logically applicable where there is a low ceiling to be considered. Extensive light distribution permits normal spacings for adequate coverage, despite low ceiling.

Performance: These In-Bilt reflector-refractors, make possible recessed installations with a minimum of installation expense. Maintenance is low because of the dirt-resisting construction of the units. Easy relamping is accomplished by unthreading the glassware from the screw neck fitting. Asymmetric units have orienting fitters with screw adjustment to allow proper positioning to assure full realization of the special light patterns.



Nos. R-2470, R-2472

SPACING 2xMH		EFF 59.9%	
M.F.	EXTENSIVE	0.8% ↑	
G.90	R-2460		
M.85	R-2470	59.1% ↓	
P.80	DISTRIBUTION		
CEILING	75%	50%	
WALLS	50%	30%	10%
ROOM INDEX	COEFFICIENT OF UTILISATION		
J	.24	.21	.19
I	.30	.27	.24
H	.32	.30	.27
G	.35	.32	.29
F	.37	.35	.33
E	.40	.38	.36
D	.43	.41	.39
C	.44	.43	.42
B	.46	.45	.44
A	.47	.46	.45

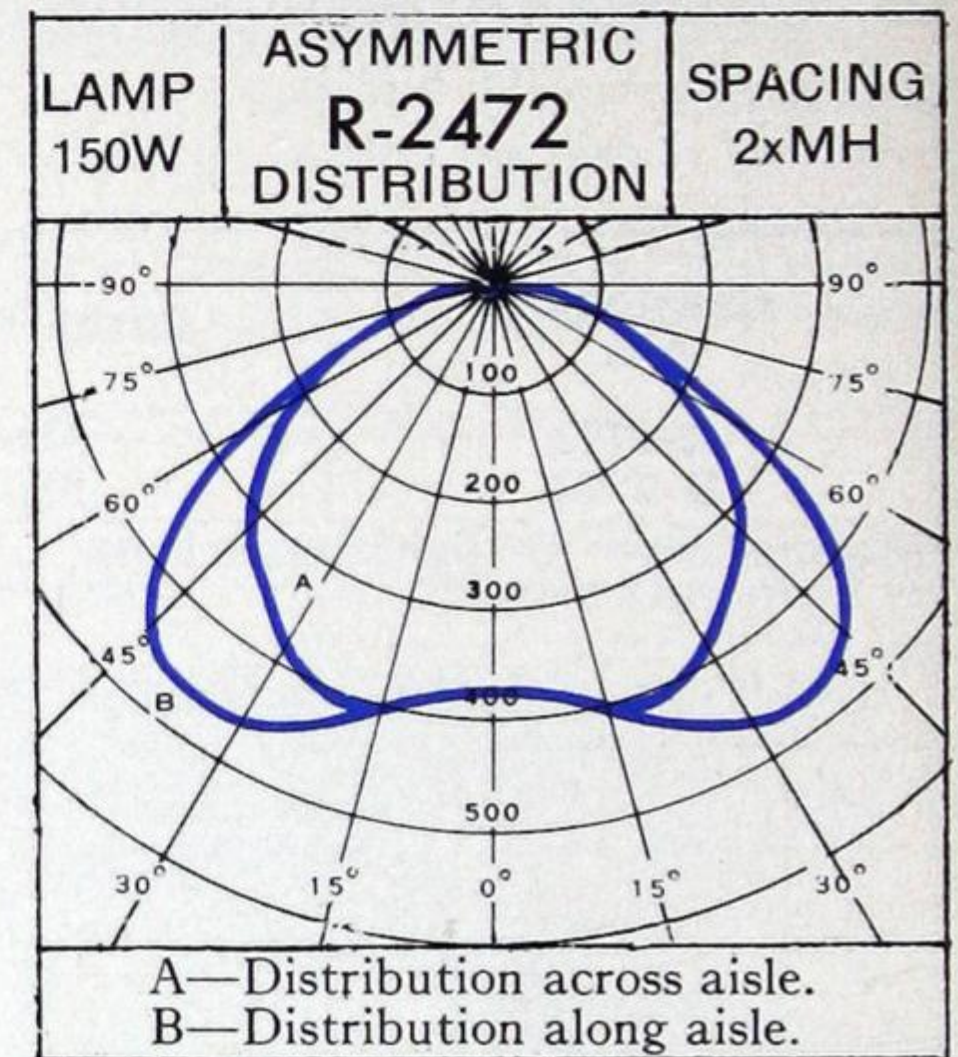
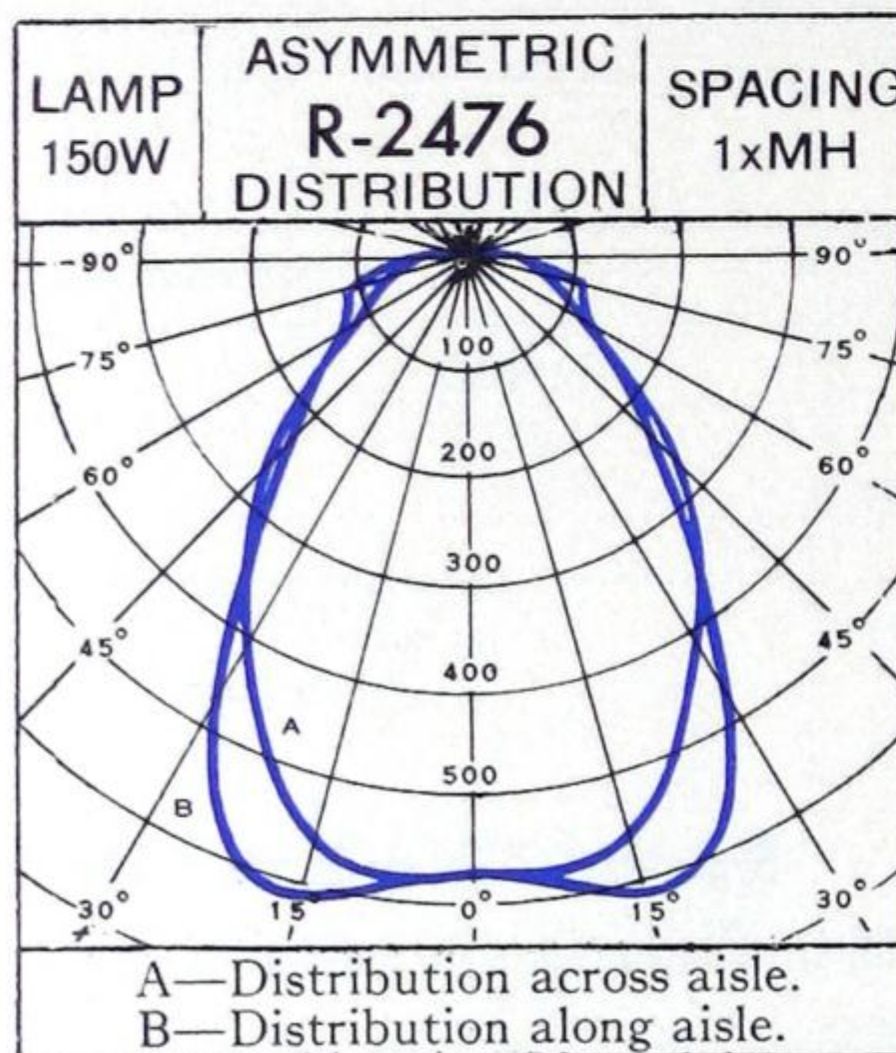

Catalogue No.	Lamp Watts	Dimensions			
		Recessed Depth	Plaster Opening	Finishing Ring Diam.	Depth Exposed Part of Unit
R-2460	150	7 1/2"	11 7/8" Dia.	12 3/8"	3 1/8"
R-2470	150	7 1/2"	11 7/8" Dia.	12 3/8"	4"
R-2472	150	7 1/2"	11 7/8" Dia.	12 3/8"	4"
R-2476	150	7 1/2"	11 7/8" Dia.	12 3/8"	3 1/8"



No. C-2172

Holophane Corridor Lighting Unit

No. C-2172 is specifically designed for the lighting of corridors or similar long narrow traffic spaces. It delivers an asymmetrical light pattern; the light is widely spread along the length of the area and restricted across the width. This unit is more superior for this particular application than units spreading light equally in all directions.

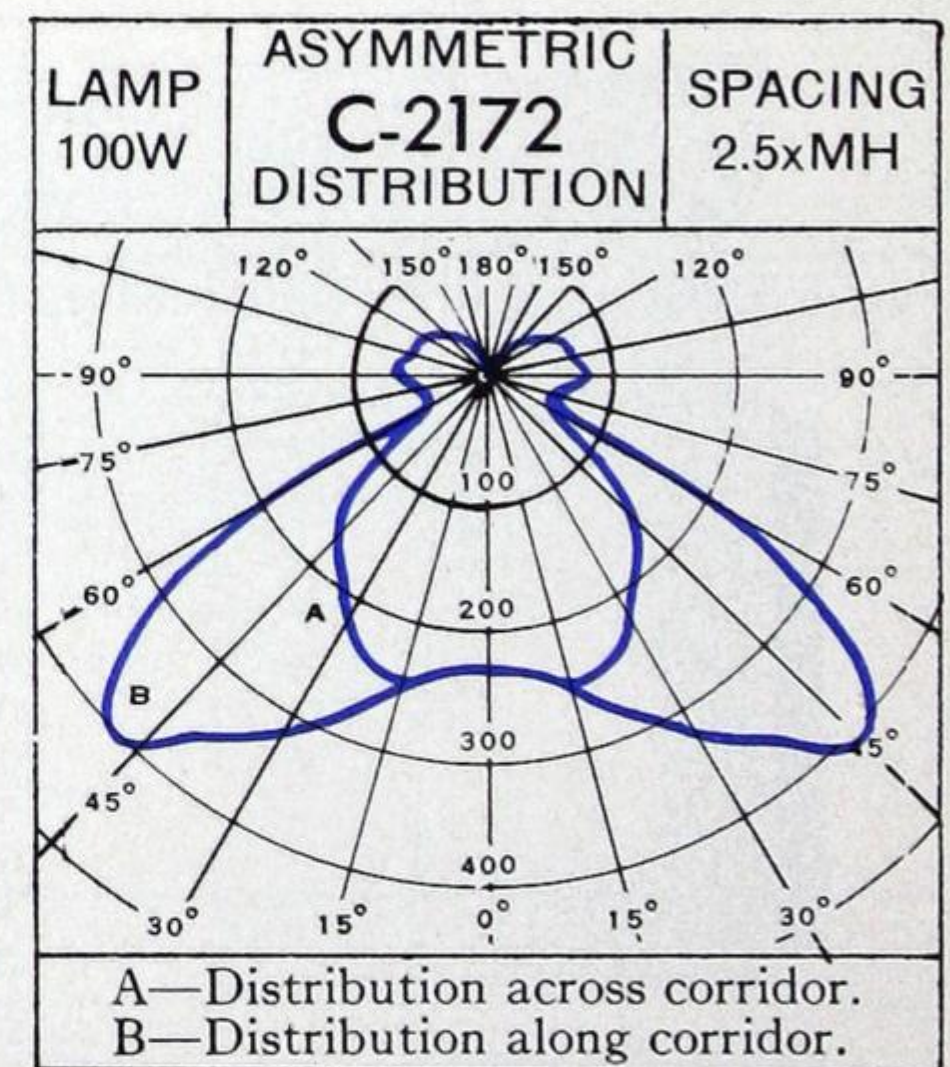

Catalogue No.	Lamp Watts	Distribution	Dimensions	
			Diameter	Depth
C-2172	100*-150	Asymmetric	9 7/8"	12"

*Use 1 3/8" Extension for 100 watt lamp.



PRISMATIC GLASSWARE UNITS

Holophane Stockroom and Bookstack Units

Narrow aisle conditions are best treated with units having an asymmetric distribution (more light in some directions than in others). To mention just two of these:

- 1—Odd shaped areas such as aisles or corridors;
 - 2—Reading or other work operations on vertical or sloping surfaces.
- No. H-2076-S is of excellent service as it provides uniform illumination on shelves from top to bottom and from unit to unit when spaced as recommended herein. The glassware is conspicuously marked to ensure correct orientation of unit and correct distribution of light along corridor.



No. H-2076-S

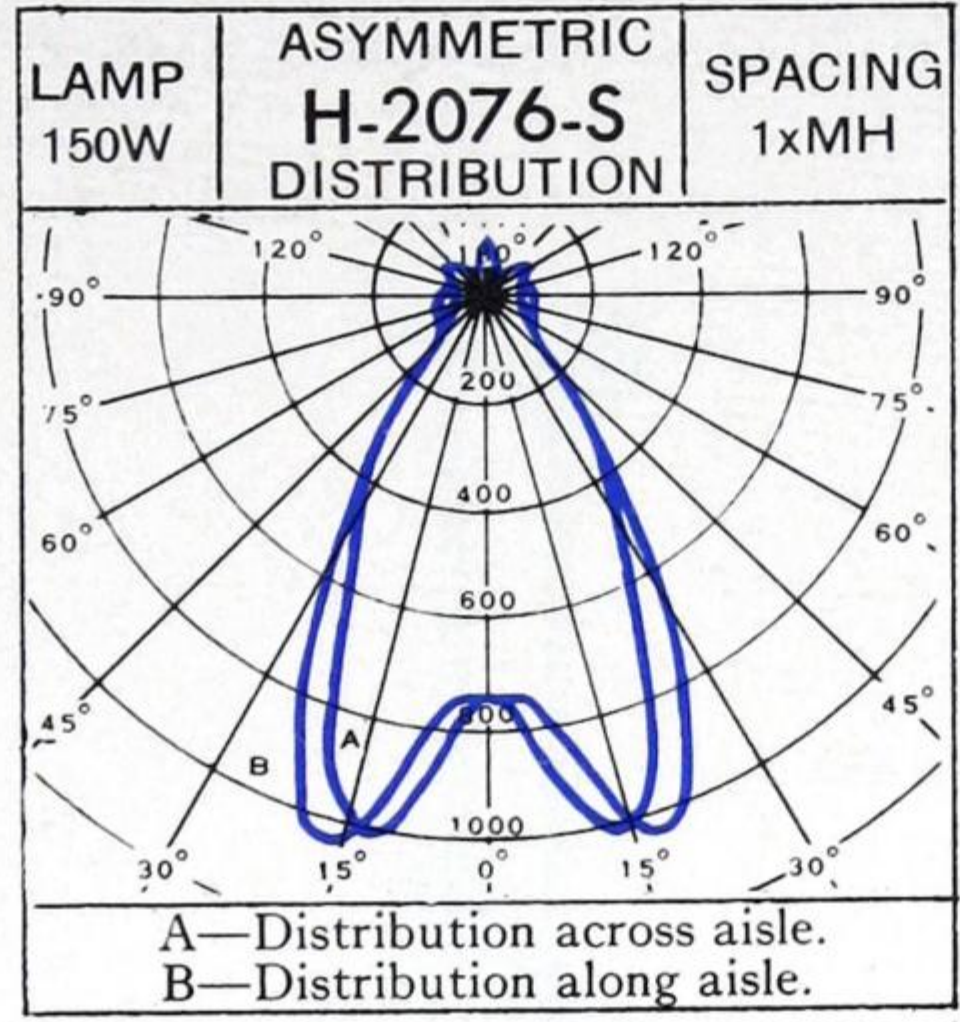

No. 02076

Catalogue No.	Lamp	Distribution	Dimensions		Mounting
			Glass Diameter	Overall Depth	
H-2076-S	100†-150W	Asymmetric	8 ³ / ₄ "	10 ³ / ₈ "	Tapped 1/2"
02076*	60W	Asymmetric	8 ³ / ₄ "	6 ⁵ / ₈ "	Clamping Fitter for Grooved Socket

*No socket supplied with this unit. †Use 1³/₈" socket extension with 100W Lamp.

Holophane Filterlite (R) Unit

This unit combines beauty and eye comfort with the greatest lighting efficiency for semi-indirect lighting. Entirely luminous to avoid contrast with the ceiling. Low surface brightness. Minimum dust and dirt depreciation; easy cleaning restores original efficiency. Light on ceiling is widespread and uniform, without streaks or shadows.

The unit is smooth outside and tightly enclosed. The upper portion is sloped so that a minimum of dust gathers on the surface. The lower section of the unit is lined with a dense diffusing glass section.

Units are available with either close-ceiling fitter (CF-200) or for suspension mounting (F-200).



No. CF-200



No. F-200

SPACING 1.25xMH EFF 79.0%						
M.F.	INVERTED EXTENSIVE					61.5%
G.75	CF200-F200					
M.65	DISTRIBUTION					17.5%
P.55						
CEILING	75%		50%			
WALLS	50%	30%	10%	50%	30%	10%
ROOM INDEX	COEFFICIENT OF UTILISATION					
J	.15	.11	.09	.12	.09	.07
I	.18	.15	.13	.15	.12	.10
H	.21	.18	.15	.17	.14	.12
G	.25	.21	.18	.20	.16	.14
F	.27	.23	.20	.22	.18	.16
E	.31	.27	.25	.24	.21	.19
D	.34	.30	.27	.27	.23	.21
C	.36	.32	.29	.28	.25	.23
B	.40	.36	.33	.31	.28	.26
A	.42	.38	.36	.33	.30	.28

Catalogue No.	Lamp Watts*	Distribution	Dimensions	
			Diameter	Depth
CF-200	200/300	Inverted Extensive	14"	17 ³ / ₄ "
F-200	200/300	Inverted Extensive	14"	35 ³ / ₄ "

*Medium Base, 6" light center lamp.

(R) The Holophane Co. Ltd.

COMMERCIAL LIGHTING
INCANDESCENT



PRISMATIC GLASSWARE UNITS

Holophane Correctalite (R) Unit

The Correctalite combines the effectiveness of direct lighting with the eye comfort of an indirect system.

Prismatic control directs light down on the work; there is sufficient upward light for pleasing ceiling illumination. Enclosed construction improves maintenance; easy cleaning restores the high original efficiency. Simple contour design prevents units from being soon outmoded.

Correctalite affords all the design and lighting advantages of Controlens lighting for interiors not structurally suited for recessed installations. These units are available in three types of mounting: 1—Close ceiling (C-5540), 2—Stem suspension with ball and socket alignment (S-5540), 3—Semi-recessed construction (R-5544).



No. C-5540

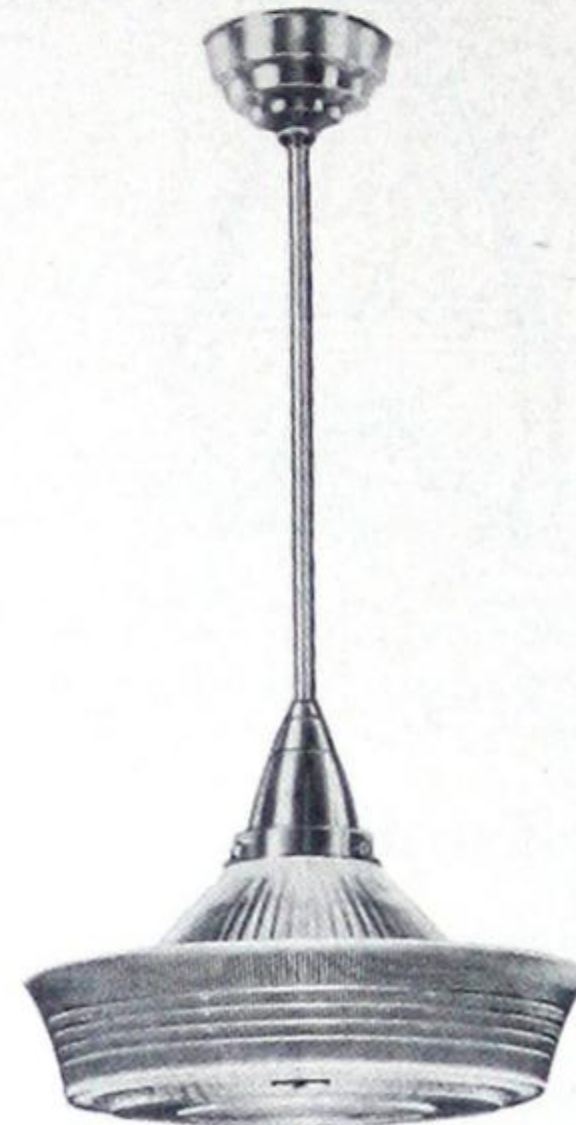

No. S-5540



No. R-5544

Catalogue No	Lamp Watts*	Distribution	Dimensions			
			Glass Diameter	Overall Length	Face Plate Diameter	Recessed Depth
C-5540	200-300	Intensive	15 3/8"	12"	—	—
S-5540	200-300	Intensive	15 3/8"	32 1/2"	—	—
R-5544	200-300	Intensive	16"	—	19"	6 3/8"

*Medium Base, 6" light center lamp.

(R) The Holophane Co. Ltd.

SPACING 1.25xMH EFF 81.0%

M.F.	INTENSIVE DISTRIBUTION		21.0% ↑		60.0% ↓	
G.85	C-5540					
M.80						
P.65						
CEILING	75%		50%			
WALLS	50%	30%	10%	50%	30%	10%
ROOM INDEX	COEFFICIENT OF UTILISATION					
J	.33	.29	.27	.32	.28	.27
I	.40	.37	.35	.38	.35	.34
H	.44	.41	.39	.42	.39	.38
G	.48	.45	.43	.45	.43	.40
F	.51	.48	.45	.48	.45	.43
E	.55	.52	.49	.52	.49	.47
D	.59	.55	.52	.55	.52	.50
C	.61	.58	.54	.57	.55	.52
B	.64	.60	.58	.59	.56	.55
A	.65	.62	.60	.61	.58	.56

SPACING 1.25xMH EFF 81.0%

M.F.	INTENSIVE DISTRIBUTION		21.0% ↑		60.0% ↓	
G.85	S-5540					
M.80						
P.65						
CEILING	75%		50%			
WALLS	50%	30%	10%	50%	30%	10%
ROOM INDEX	COEFFICIENT OF UTILISATION					
J	.33	.29	.27	.32	.28	.27
I	.40	.37	.35	.38	.35	.34
H	.44	.41	.39	.42	.39	.38
G	.48	.45	.43	.45	.43	.40
F	.51	.48	.45	.48	.45	.43
E	.55	.52	.49	.52	.49	.47
D	.59	.55	.52	.55	.52	.50
C	.61	.58	.54	.57	.55	.52
B	.64	.60	.58	.59	.56	.55
A	.65	.62	.60	.61	.58	.56

SPACING 1.25xMH EFF 60.4%

M.F.	INTENSIVE DISTRIBUTION		2.5% ↑		57.9% ↓	
G.90	R-5544					
M.85						
P.70						
CEILING	75%		50%			
WALLS	50%	30%	10%	50%	30%	10%
ROOM INDEX	COEFFICIENT OF UTILISATION					
J	.31	.29	.27	.30	.28	.27
I	.37	.35	.34	.37	.35	.34
H	.40	.39	.38	.39	.38	.37
G	.43	.42	.41	.42	.41	.40
F	.46	.44	.42	.44	.43	.41
E	.48	.46	.46	.47	.45	.44
D	.51	.48	.47	.49	.47	.46
C	.52	.50	.48	.51	.49	.47
B	.53	.51	.50	.52	.50	.49
A	.54	.53	.51	.53	.51	.50

PRISMATIC GLASSWARE UNITS

Holophane Reflector-Refractor Unit



These semi-direct luminaires give effective illumination down on working areas with adequate ceiling light to avoid harsh contrasts. There is a minimum of light emitted at the glare angle (60° to 90°). Units are enclosed. Ordinary soap and water cleaning restores the original lighting efficiency. The unit is easily relamped through a removable bottom cup.

"R" Type Units include a plaster ring which is first set into position before the ceiling is plastered. Flexible wiring from the outlet box is brought to the socket in the fitter. The fitter for R-2120 series is attached to the neck of the unit and the assembly, resting on the finishing ring, is screwed into position to the ears of the plaster ring.

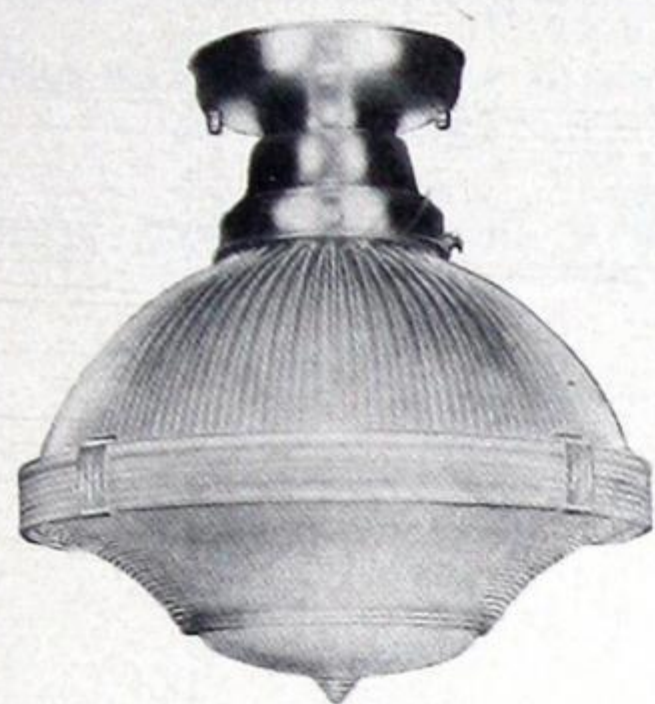

No. C-2130



No. S-2130

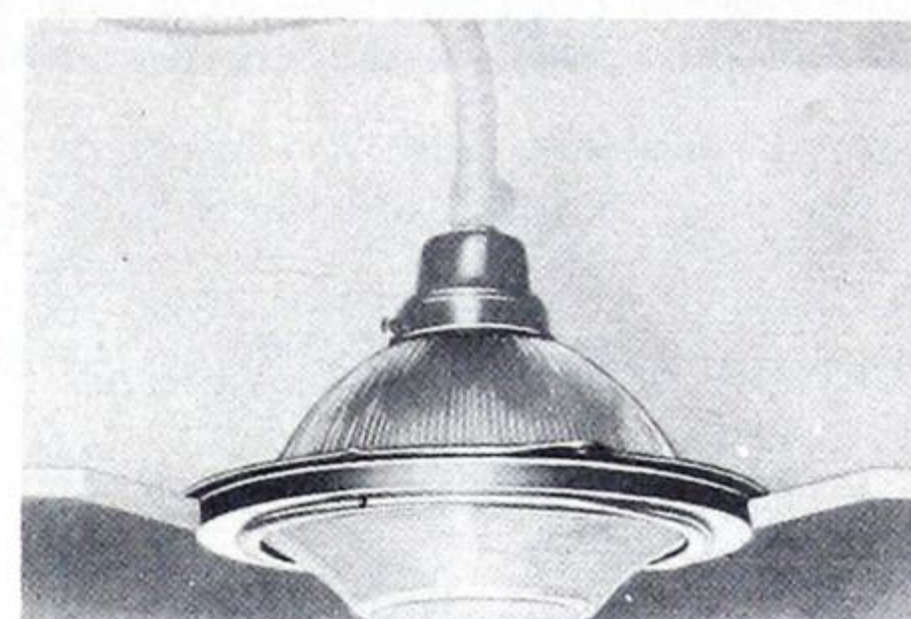

No. R-2130

Cat. No.	Lamp	Distribution	Data Table	Dimensions				Mounting
				Glass Diameter	Overall Depth	Face Plate Diameter	Recessed Depth	
C-2120	100*-150	Extensive	"A"	9 3/4"	11 1/2"	—	—	Outlet Box Strap
C-2130	200	Extensive	"A"	12"	13 1/2"	—	—	
C-2140	300-500	Extensive	"A"	14"	15"	—	—	
C-2133	200	Intensive	"B"	12"	13 1/2"	—	—	
C-2143	300-500	Intensive	"B"	14"	15"	—	—	
S-2120	100*-150	Extensive	"A"	9 3/4"	30 3/8"	—	—	3/8" Female Hickey
S-2130	200	Extensive	"A"	12"	32"	—	—	
S-2140	300-500	Extensive	"A"	14"	33 1/2"	—	—	
S-2133	200	Intensive	"B"	12"	32"	—	—	
S-2143	300-500	Intensive	"B"	14"	33 1/2"	—	—	
R-2120	150	Extensive	"C"	9 3/4"	—	12 3/8"	7"	Tapped For 1/2" Pipe
R-2130	200	Extensive	"C"	12"	—	14 3/4"	8 1/4"	
R-2140	300**	Extensive	"C"	14"	—	16 3/4"	8 1/8"	

**Medium base—6" Light Center Length—* Use 1 3/8" Socket extension for 100W lamp.

SPACING 2xMH		EFF 82.1%	
M.F.	EXTENSIVE DATA TABLE	23.4% ↑	
G.85	"A"	58.7% ↓	
M.80	DISTRIBUTION		
P.70			
CEILING	75%	50%	
WALLS	50% 30% 10%	50%	30% 10%
ROOM INDEX	COEFFICIENT OF UTILISATION		
J	.28	.23	.19
I	.35	.30	.26
H	.39	.34	.30
G	.43	.38	.34
F	.46	.41	.37
E	.51	.46	.43
D	.55	.50	.46
C	.57	.53	.49
B	.61	.57	.54
A	.63	.59	.56

SPACING 1.25xMH		EFF 81.1%	
M.F.	INTENSIVE DATA TABLE	24.1% ↑	
G.85	"B"	57.0% ↓	
M.80	DISTRIBUTION		
P.65			
CEILING	75%	50%	
WALLS	50% 30% 10%	50%	30% 10%
ROOM INDEX	COEFFICIENT OF UTILISATION		
J	.28	.23	.19
I	.35	.30	.26
H	.39	.34	.30
G	.43	.38	.34
F	.46	.41	.37
E	.51	.46	.43
D	.55	.50	.46
C	.57	.53	.49
B	.61	.57	.54
A	.63	.59	.56

SPACING 2xMH		EFF 52.3%	
M.F.	EXTENSIVE DATA TABLE	1.3% ↑	
G.90	"C"	51.0% ↓	
M.85	DISTRIBUTION		
P.80			
CEILING	75%	50%	
WALLS	50% 30% 10%	50%	30% 10%
ROOM INDEX	COEFFICIENT OF UTILISATION		
J	.24	.19	.15
I	.28	.26	.23
H	.32	.29	.26
G	.35	.32	.30
F	.37	.34	.32
E	.40	.37	.35
D	.43	.41	.39
C	.45	.43	.41
B	.47	.45	.43
A	.49	.46	.44

COMMERCIAL LIGHTING
INCANDESCENT



HOSPITAL LIGHTING UNITS

Holophane Surgery Lighting Units With Prismatic Glassware

The Holophane Major Surgery Lighting System consists of units providing eighteen light beams converging to form a high intensity spot on the operating area and feathering into a larger area of less intense light over the rest of the operating table and at the same time spreading the correct degree of general illumination over the entire room. It is without glare, interfering shadows or sensible heat. Each system is separately assembled for the particular purpose it is to serve, for the exact direction of light required and for the amount of illumination needed.

The high illumination required for surgical work is obtained by means of the eighteen separate optical systems distributed in a radial pattern and recessed in the ceiling. The optical systems are normally housed in six steel boxes, each containing three sets of lamps, reflectors and Controlens. The system is sufficiently flexible, however, to allow the three optical arrangements normally contained in one housing to be individually located in separate housings, where structural features make this a more desirable arrangement.

This wide distribution of the light sources ensures that the rays will approach the wound area from many directions. The angles have been carefully computed so that the beams of light will be safe from any normal interception by persons grouped around the table.

Special lenses are used that intercept infra-red radiation and modify the visible radiation towards true white. The reduction in spot temperature is approximately 80% over past practice.

For a planned layout embracing all the advantages of modern surgery lighting, the *Northern Electric Lighting Service* is at your disposal—CONSULT YOUR LOCAL NORTHERN ELECTRIC OFFICE.

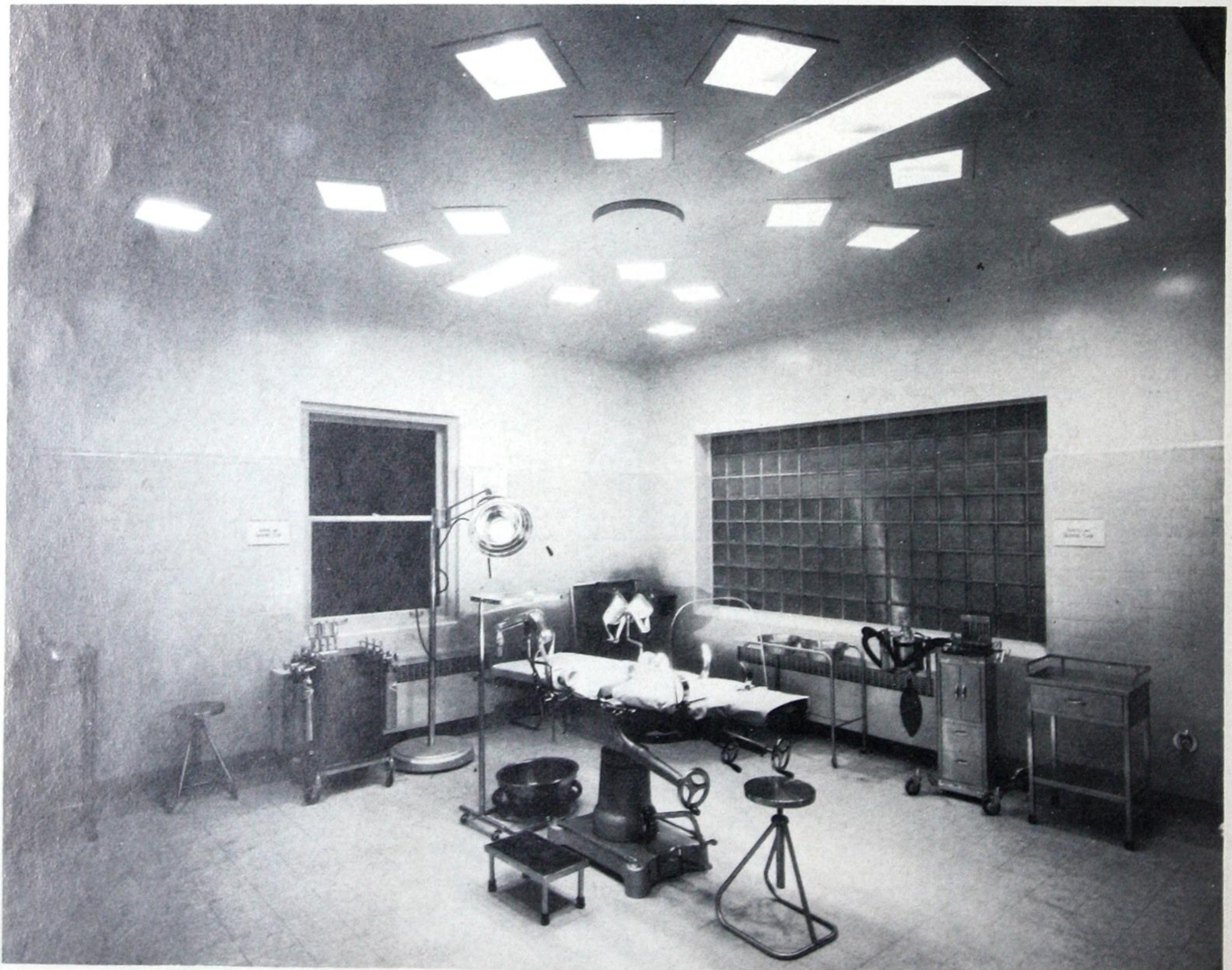



HOSPITAL LIGHTING UNITS

Holophane Surgery Lighting Units With Prismatic Glassware

Features

- Efficient:** Scientific grouping of enclosed multi-lens optics assures maintenance of intense illumination.
- Safe:** Location of lighting system remote from anesthetization zone eliminates hazards of explosion.
- Aseptic:** Permanently flushed into tight ceiling enclosure. No moving parts to dislodge dust.
- Modern:** Direction and pattern of light preset—or changed by circuit-selecting wall switches without distracting surgeon.
- Wattage and Cost:** The great increase in illumination, the improvement in visual comfort, the incorporation of thermal control and the simplicity of these surgery systems have been achieved at a decrease in wattage and a reduction in cost.

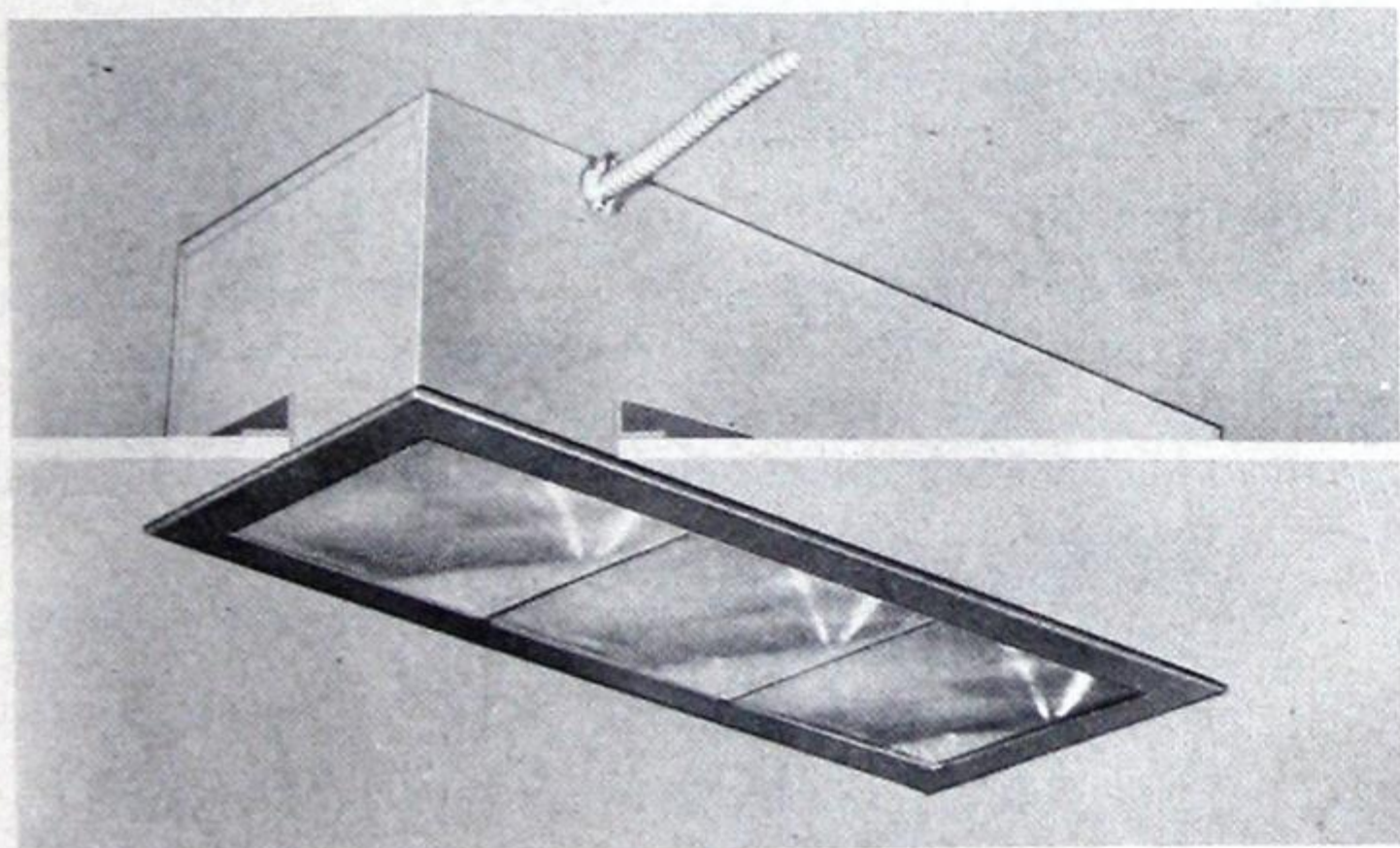
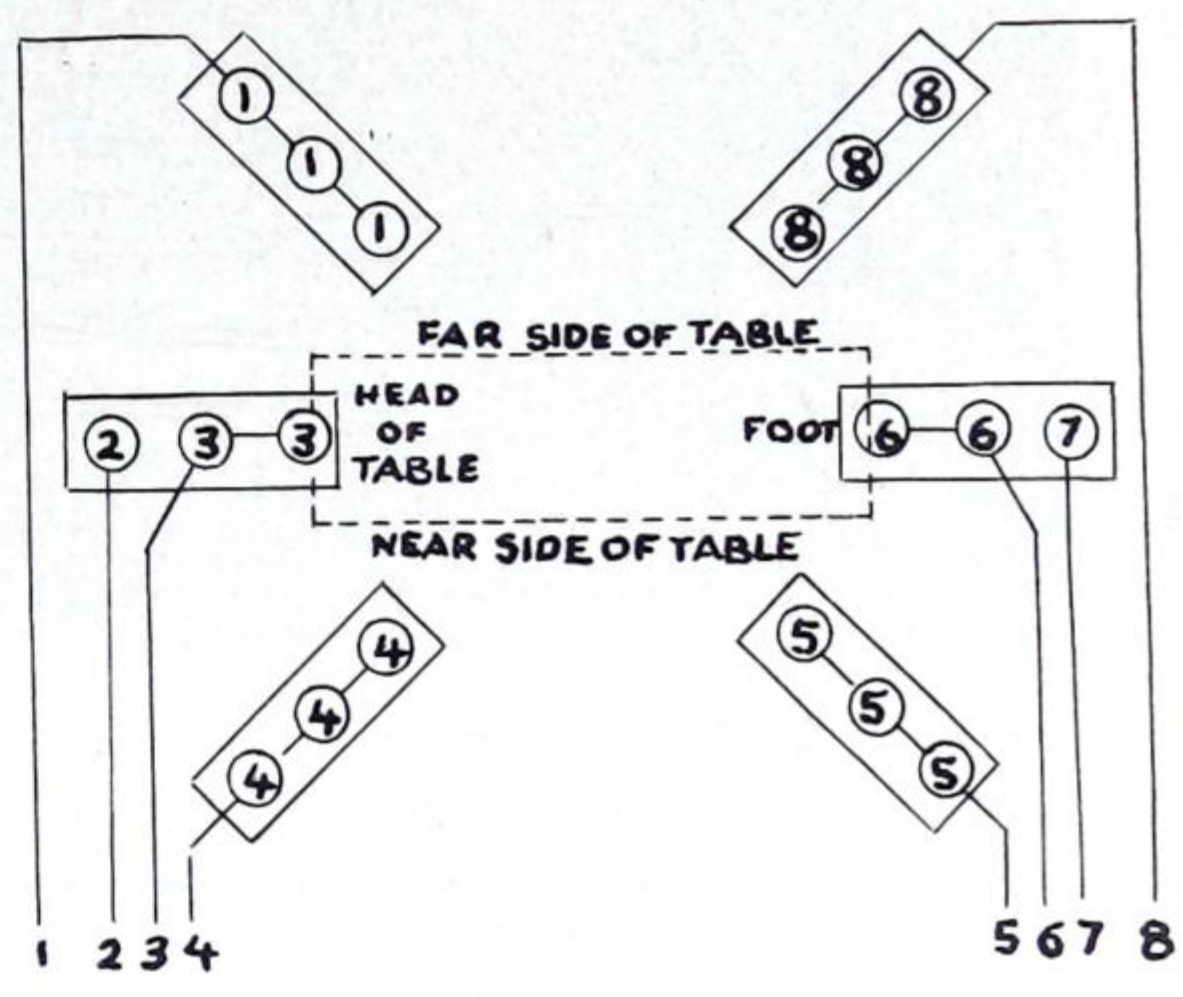
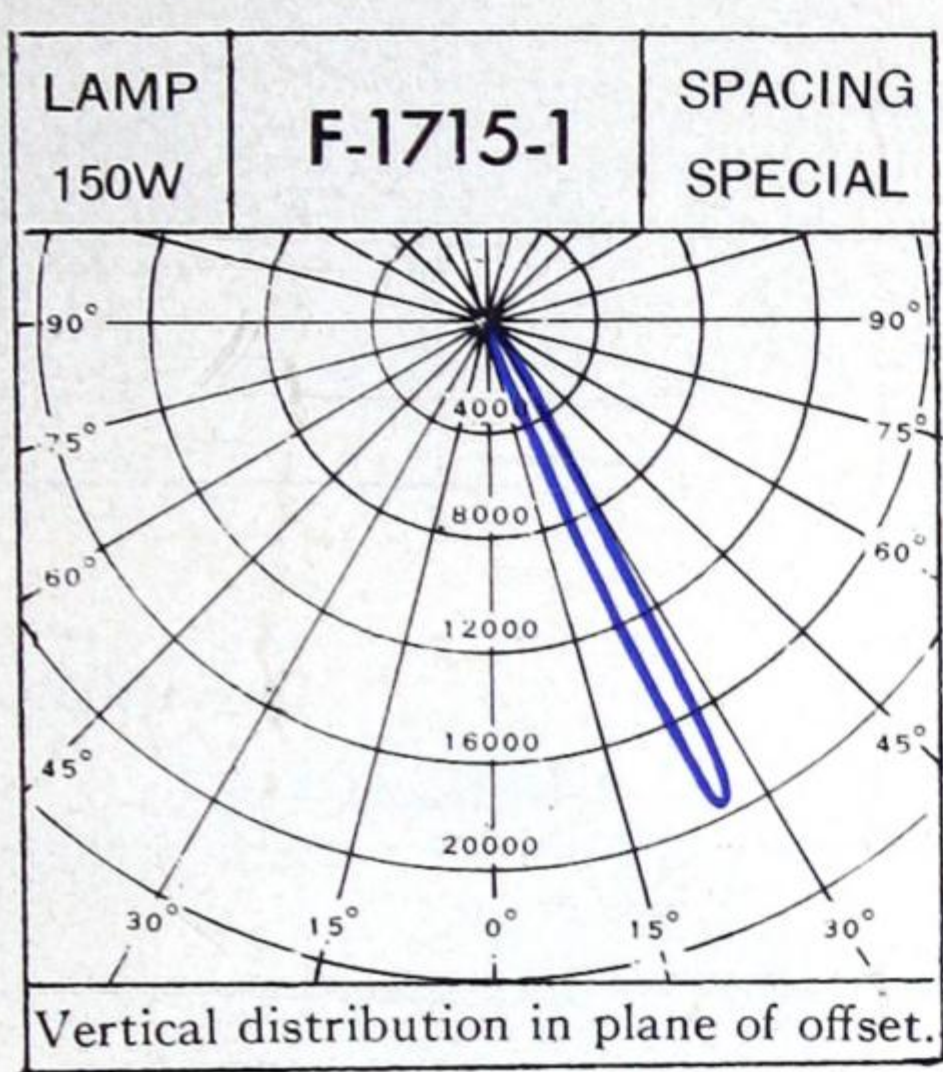

No. F-1715-3

Illustration suggests the manner in which the electrical circuits may be tied together with the optical systems so as to provide the patterns of light desirable for each type of operation.

Surgeon's Operating Position	Circuits Switched Off
Near Side of Table	5 (4 sometimes)
Far Side of Table	1 (8 sometimes)
Head of Table	2
Foot of Table	7

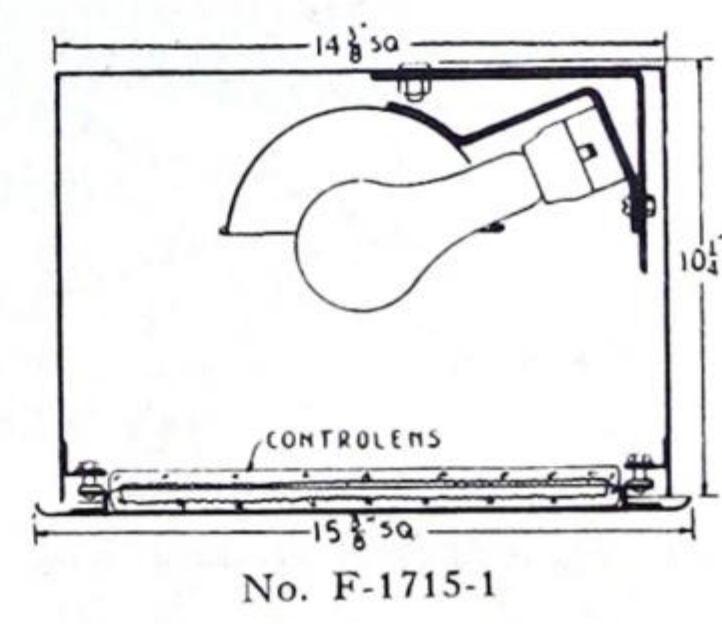
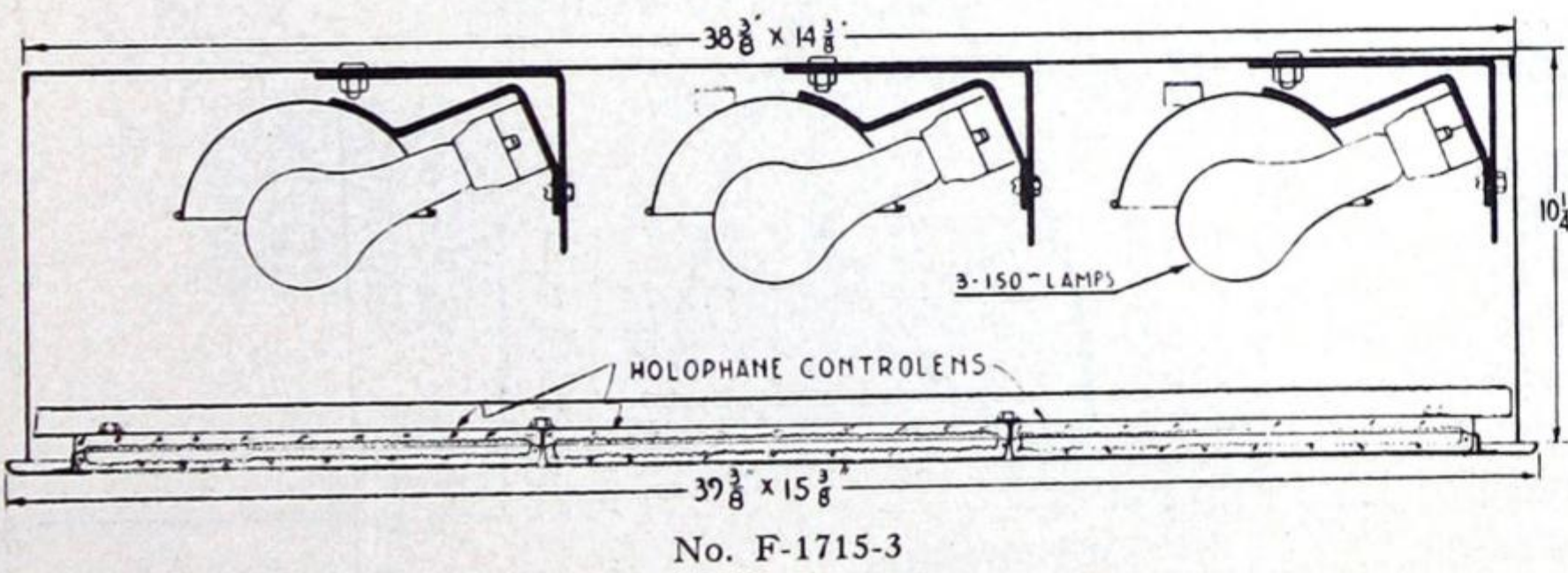

Catalogue No.	Lamp Watts	Dimensions				
		Roughing Box			Face Plate	
		Length	Width	Depth	Length	Width
F-1715-1	150	14 3/8"	14 3/8"	10 1/4"	15 3/8"	15 3/8"
F-1715-3	3x150	38 3/8"	14 3/8"	10 1/4"	39 3/8"	15 3/8"

COMMERCIAL LIGHTING
INCANDESCENT



HOSPITAL LIGHTING UNITS

Holophane Hospital Lighting Units With Prismatic Glassware

Medical Examination Unit

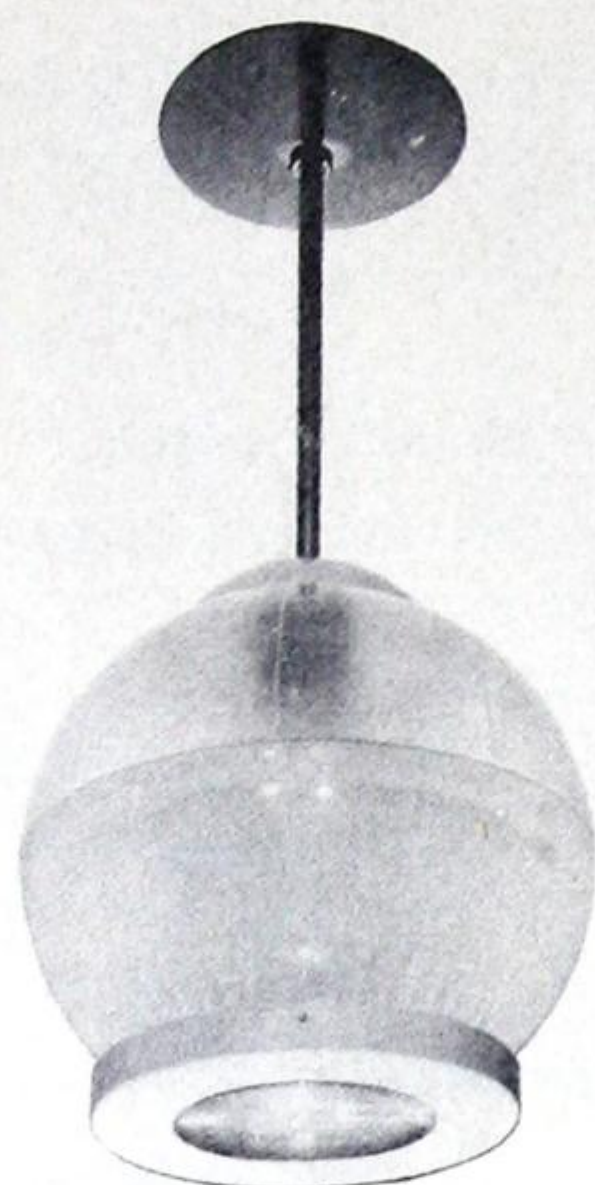

No. CS-5000

The nature of the work performed by the physician in a medical examination room calls for two types of lighting:

1. High level of general illumination to light the entire room.
2. An intense beam directly on the examination table when he is checking the patient.

The medical examination unit is a double duty lighting devise satisfying both requirements.

The prismatic glass unit is totally enclosed, the outside of the glassware and the fixture is smooth, will not harbour dust and is simple to maintain. A standard 500 watt incandescent lamp is used, and is easily accessible through the hinged bottom section of the unit.

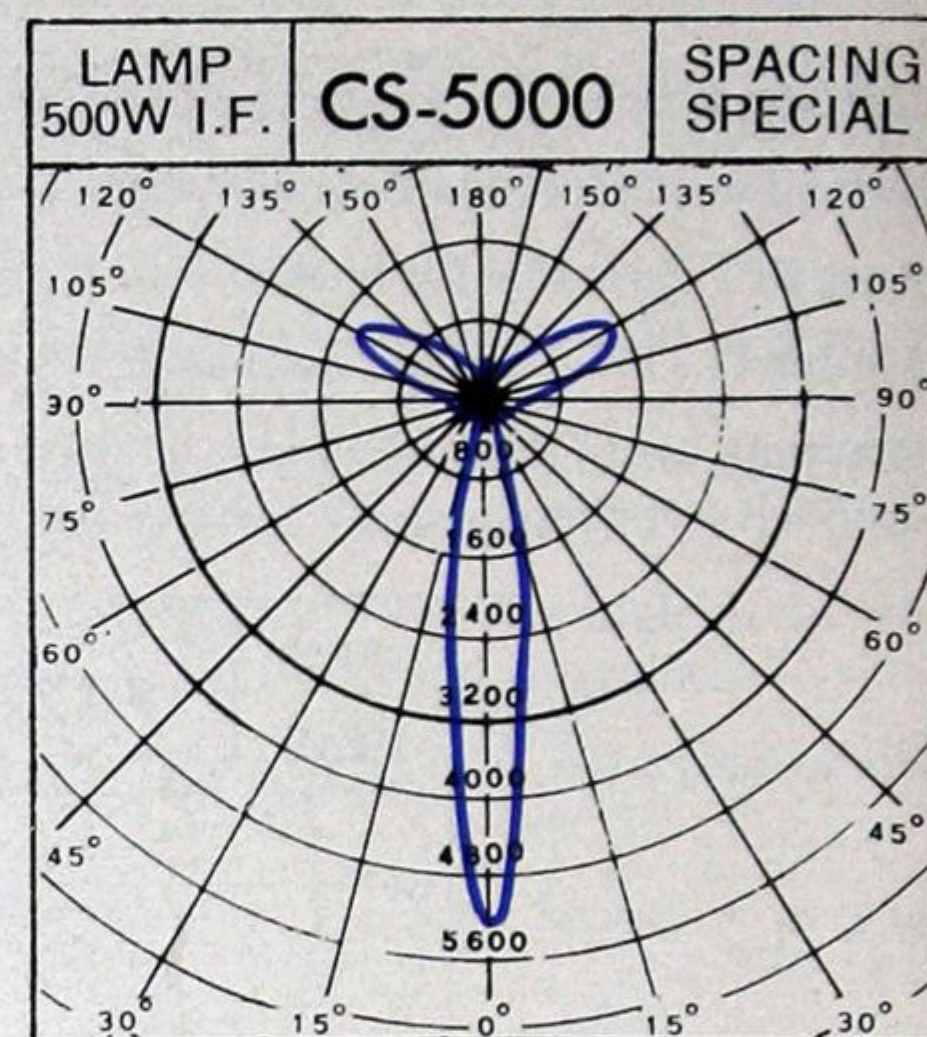

Catalogue No.	Lamp Watts	Distribution	Dimensions	
			Bowl Diam.	Overall Depth
CS-5000	500 I.F.	Combination Direct-Spot and Semi-Indirect.	14"	36"

Psychiatric Ward Unit

The need for keeping psychiatric patients under strict control and at the same time preventing them from harming themselves, dictates the mechanical features of the lighting system.

These special purpose units have the following characteristics which make them suitable for this critical application:

1. The unit is designed for flush installation in the ceiling—the hardest place for the patient to reach.
2. The unit is constructed as strong mechanically as possible.
3. The Controlens is protected by shatterproof glass.
4. Unit can only be opened with special tool.
5. The unit is dust-tight and requires a minimum of maintenance; it need be opened only to replace burned-out lamps.
6. The units contain, in addition to the main lamp, an adjustable 10 watt auxiliary lamp which may be located to throw the night light beam away from the bed so as not to awaken or disturb the patient.

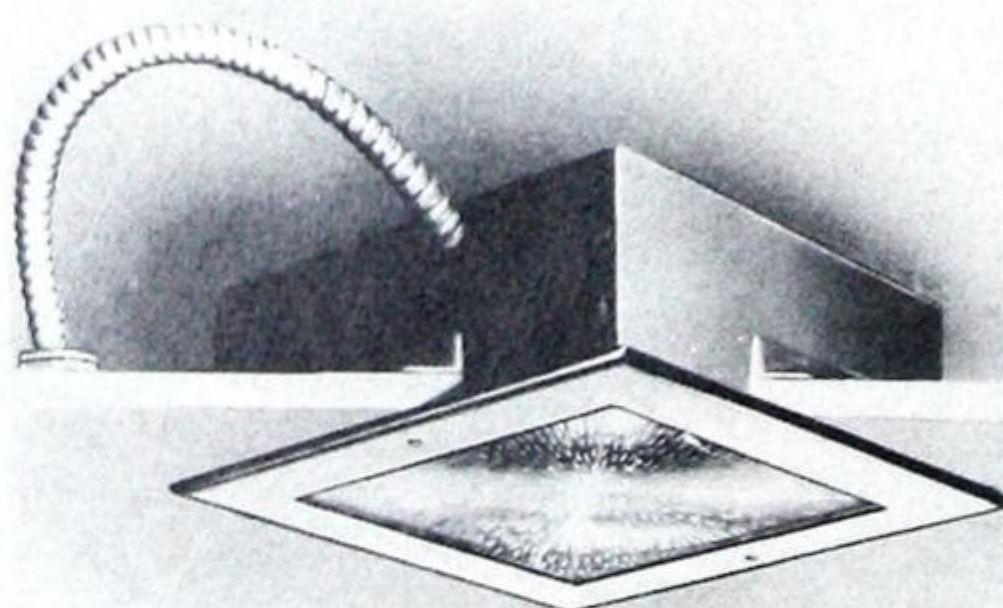

PSYCHIATRIC UNIT

SPACING .75xMH		EFF 35.4%	
M.F.	INTENSIVE		
G.90	A 739-100	0%	
M.85	A 739-150	35.4%	
P.80	DISTRIBUTION		
CEILING	75%	50%	
WALLS	50% 30% 10%	50% 30% 10%	
ROOM INDEX	COEFFICIENT OF UTILISATION		
J	.20	.19	.18
I	.24	.24	.23
H	.26	.25	.25
G	.28	.27	.27
F	.29	.28	.28
E	.30	.30	.30
D	.32	.30	.31
C	.32	.31	.32
B	.33	.32	.32
A	.33	.32	.32

Catalogue No.	Lamp Watts	Dimensions						
		Roughing Box			Face Plate		Plaster Ring	
		Length	Width	Depth	Length	Width	Length	Width
A-739-60	60	10 1/2"	10 1/2"	4 1/2"	11 3/4"	11 3/4"	10 3/4"	10 3/4"
A-739-100	100	10 1/2"	10 1/2"	4 1/2"	11 3/4"	11 3/4"	10 3/4"	10 3/4"
A-739-150	150	10 1/2"	10 1/2"	4 1/2"	11 3/4"	11 3/4"	10 3/4"	10 3/4"
A-765	200	14 1/8"	14 1/8"	6"	15 3/8"	15 3/8"	14 3/8"	14 3/8"

Plaster rings not furnished with this type of unit.



HOSPITAL LIGHTING UNITS

Amalgamated Incandescent Hospital Bed Lamp

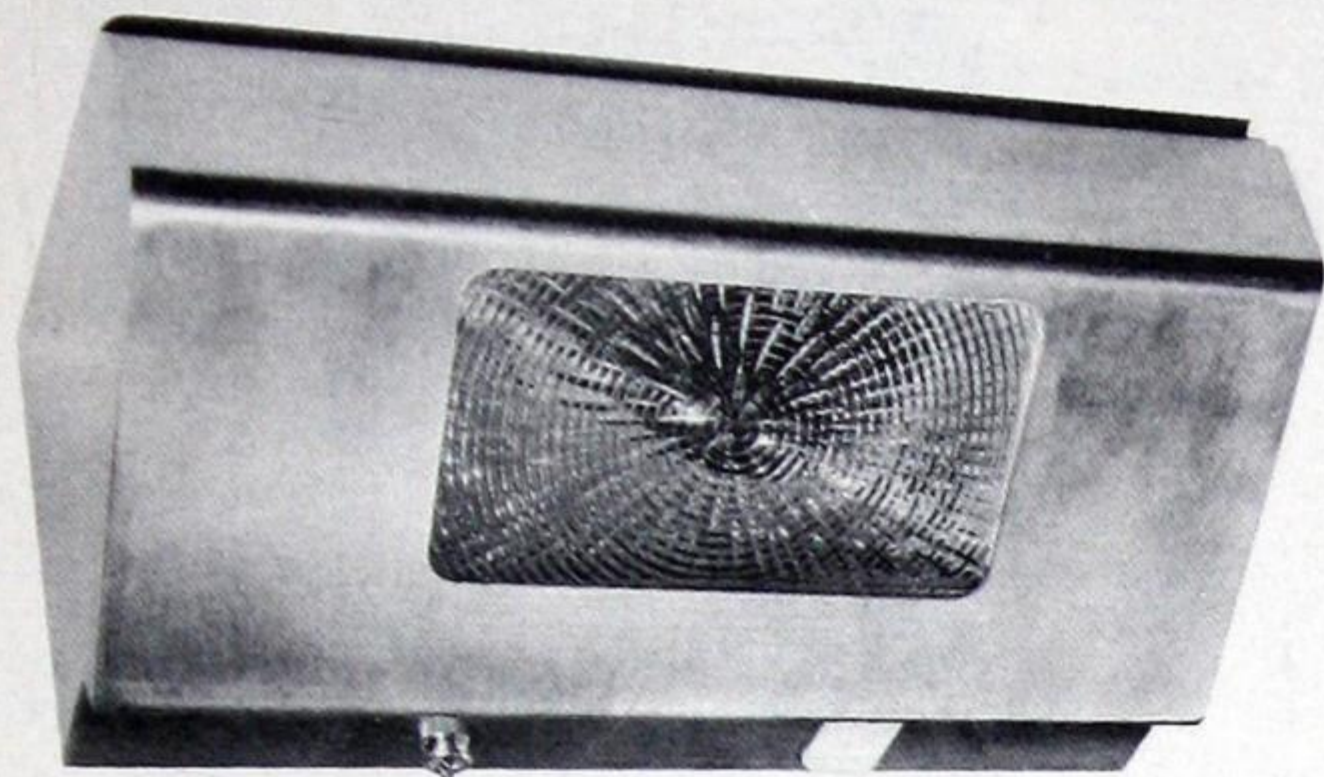

UNDERSIDE—SHOWING DIRECT LENS, SWITCH, AND PLUG RECEPTACLE

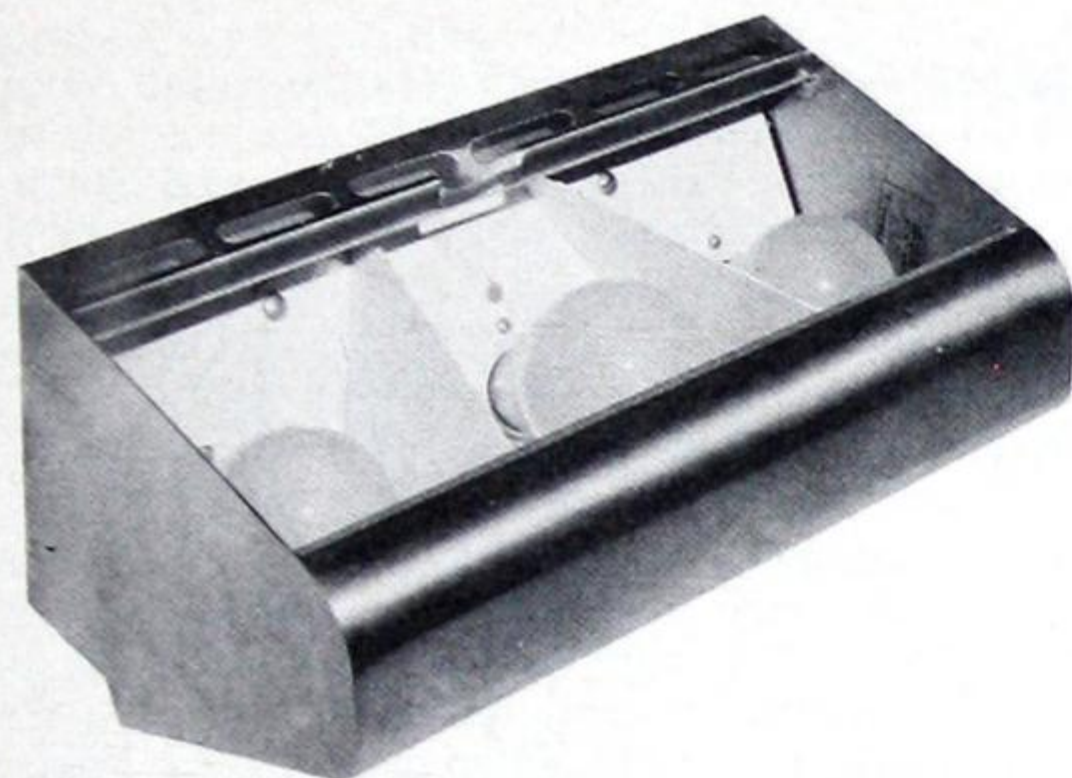
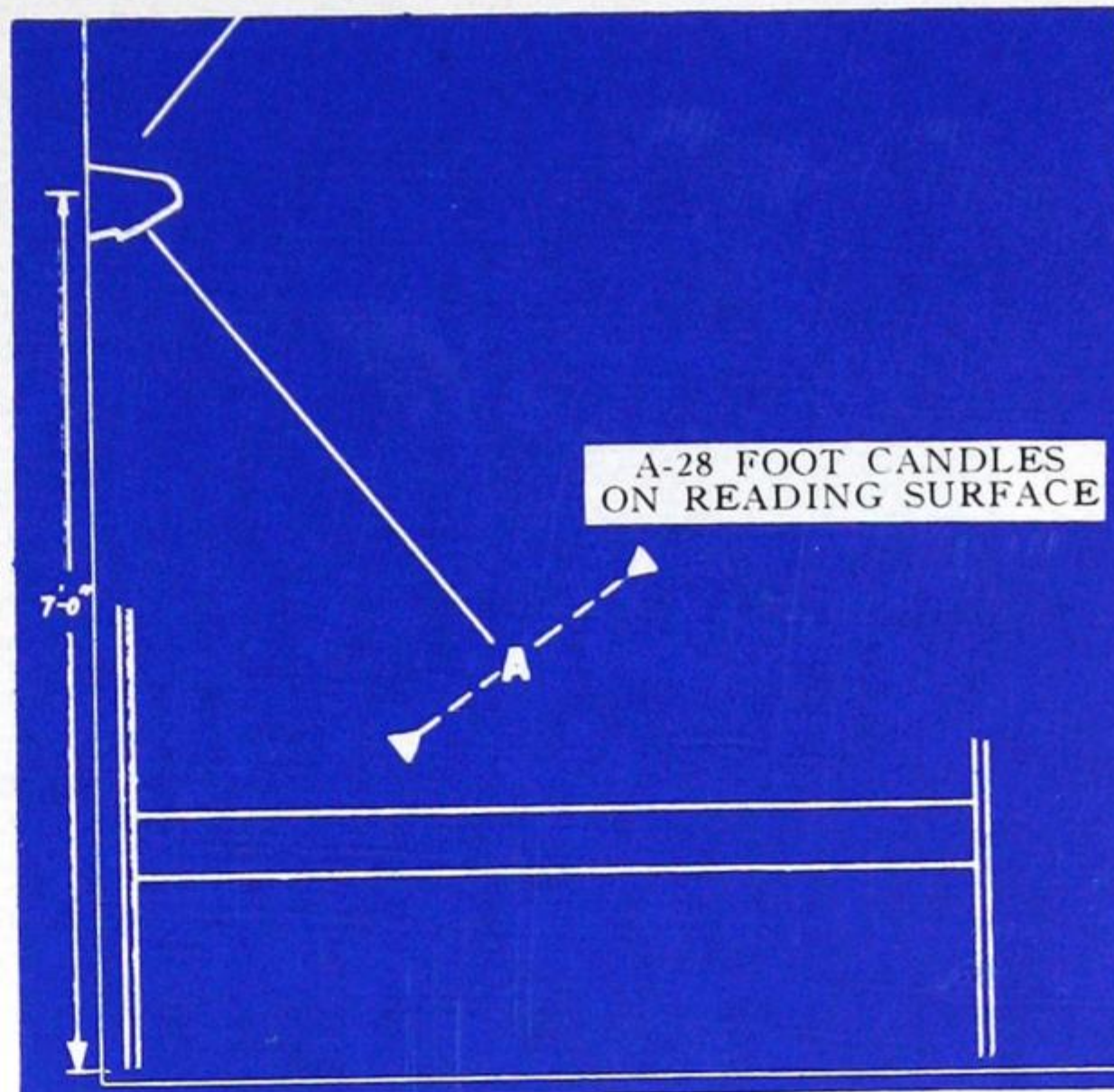

TOP VIEW—WITH ALBALITE GLASS COVER REMOVED

The Amalgamated hospital bed unit provides an indirect component from 2-60 watt lamps for general illumination and a direct component with fresnel lens from a third 60 watt lamp for reading. Both components may be switched independently, the downward component from a switch on the unit itself, and the upward component remotely from a switch on the wall. Where it is desired to control both upward and downward switching from the unit itself, this should be specified.

The unit is finished in baked white enamel and has a built-in convenience outlet.

Catalogue No.	Description	Dimensions		
		Height	Width	Depth
310-B	Single Circuit Switch and convenience outlet*	5 $\frac{3}{4}$ "	12"	7"

*Two circuit switch available if specified.

Electrolier Fluorescent Hospital Bed Lamp

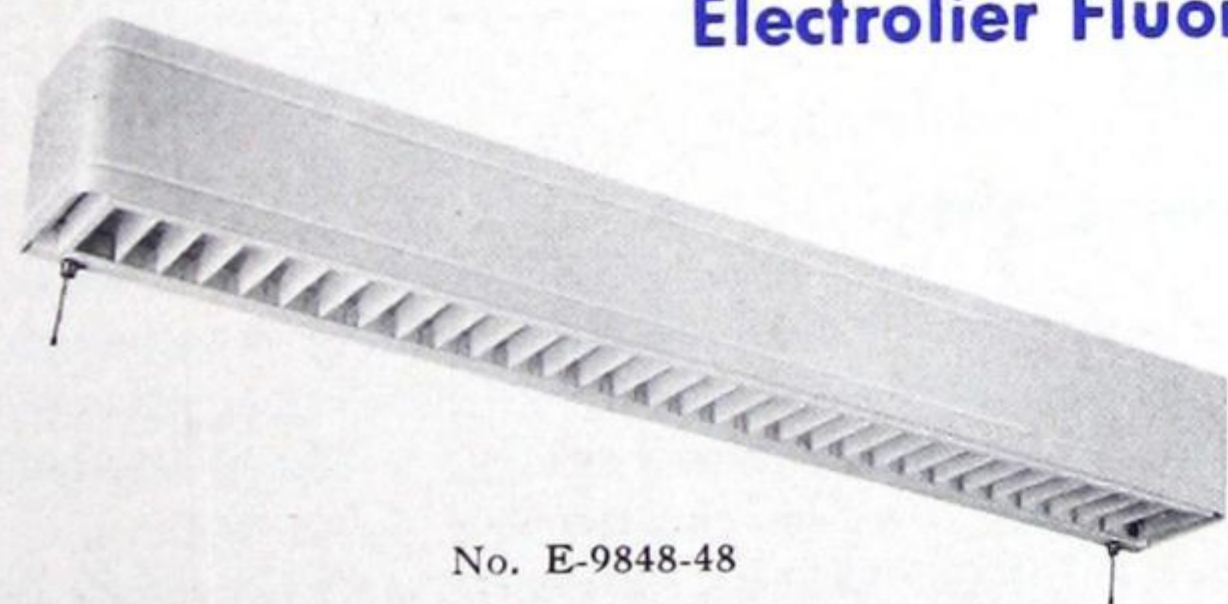

No. E-9848-48

These fluorescent bed lights provide an indirect and a direct component and are available to accommodate either 20 watt or 40 watt lamps. The bottom of the unit is louvered to shield the light source from other patients. Independent switches for each lamp are supplied, but if specified a single switch controlling the direct component only will be furnished, where it is desired to control the upward component of a number of units by a single wall switch.

When ordering state whether ballast is to be enclosed in fixture or to be supplied separately for remote mounting.

Catalogue No.	Fluorescent Lamp Watts	Dimensions		
		Width	Depth	Extension
E9848-24	2 x 20	24 $\frac{1}{2}$ "	6 $\frac{1}{4}$ "	6"
E9848-48	2 x 40	48 $\frac{1}{2}$ "	6 $\frac{1}{4}$ "	6"

COMMERCIAL LIGHTING
INCANDESCENT



HOSPITAL LIGHTING UNITS

Curtis Incandescent Hospital Bed Lamps

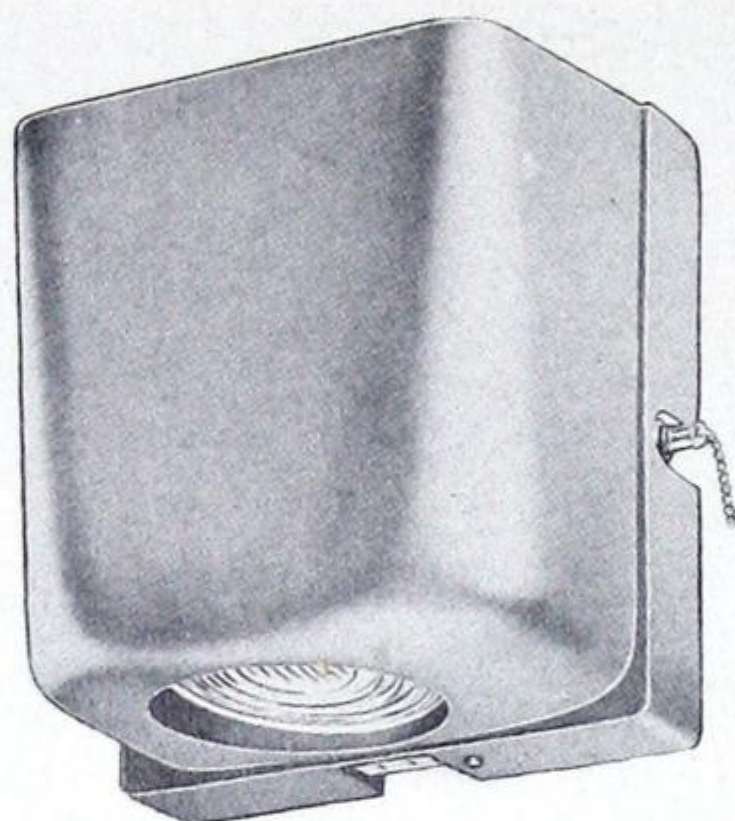

UNDERSIDE—SHOWING DIRECT LENS, SWITCH, AND PLUG RECEPTACLE

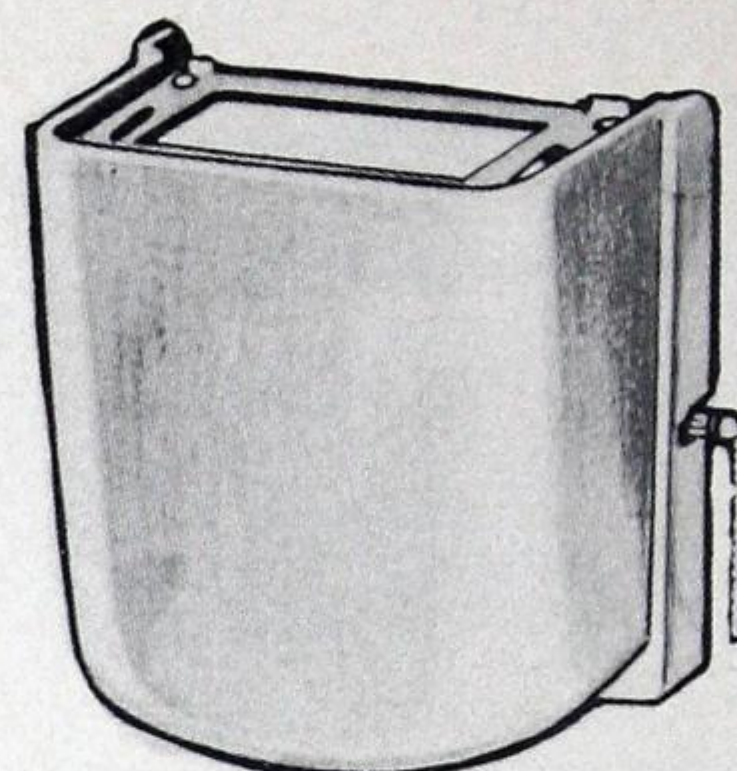

TOP VIEW—SHOWING INDIRECT DIFFUSING GLASS COVER

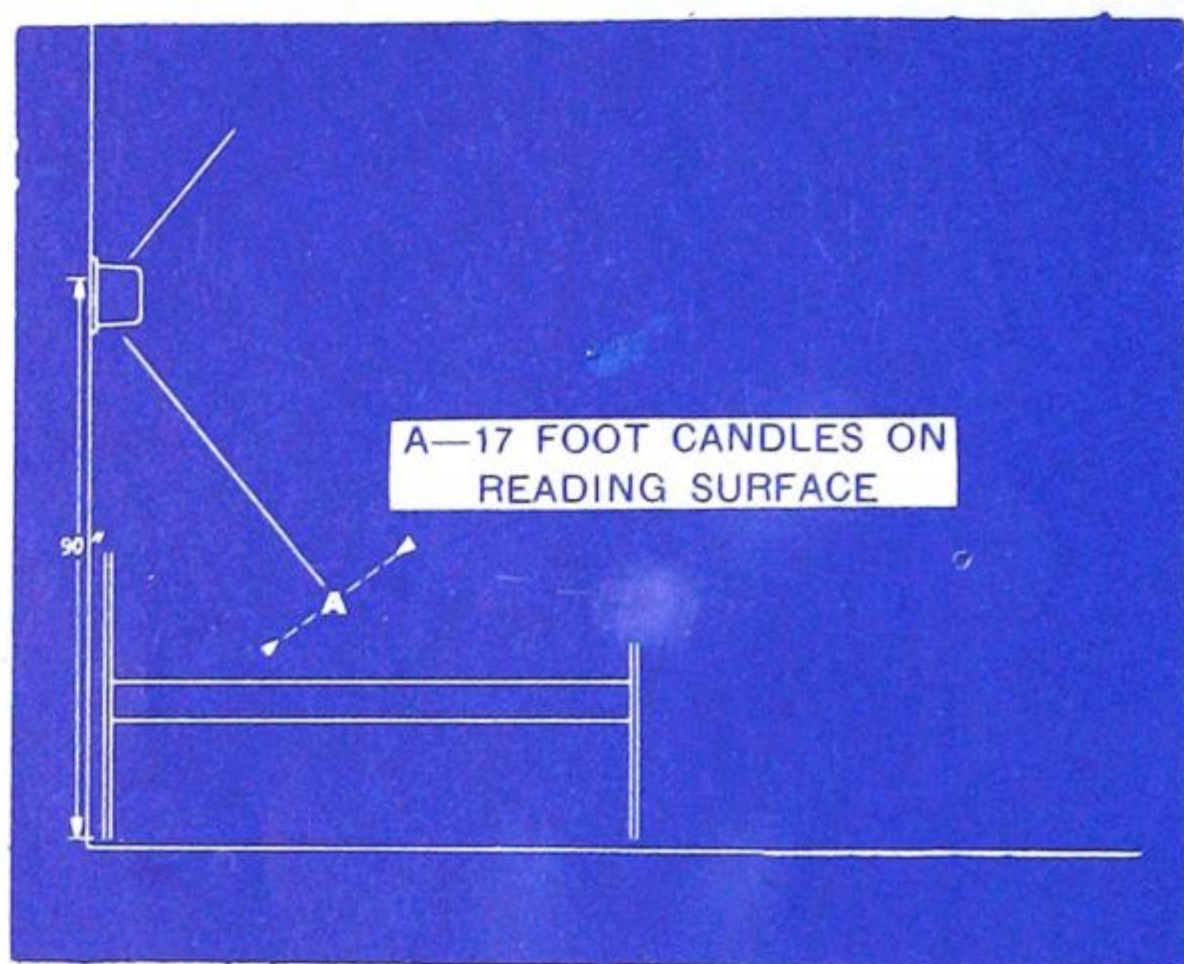

Curtis "Dua-Lite" is an attractive unit designed to provide soft, subdued indirect illumination for general hospital room lighting as well as direct illumination for the patient's reading light. The housing is cast aluminum and has a fine textured finish which is readily painted after installation to blend with the room interior. A Fresnel lens is utilized to control distribution of the 60-watt lamp used for the direct component, while the indirect component is supplied by an efficient Alzak Aluminum reflector, softly diffusing the light from the A-23, 150-watt lamp throughout the room.

These units are supplied with either a single circuit or a two circuit switch. The single circuit switch controls only the direct component, the indirect being controlled by a wall switch. The two circuit switch allows independent switching of the two components. A convenience outlet is provided in the bottom of the housing. Where no outlet box is available for mounting, the unit can be supplied with 10' cord and plug.

FOR 1-60W AND 1-150W LAMPS

Catalogue No.	Description	Dimensions		
		Width	Depth	Height
82	Single Circuit Switch	8 1/8"	6 3/8"	9 3/8"
82T	Two-way Circuit Switch	8 1/8"	6 3/8"	9 3/8"
82CP	Single Circuit Switch with 10' cord and plug	8 1/8"	6 3/8"	9 3/8"
82TCP	Two-way Circuit Switch with 10' cord and plug	8 1/8"	6 3/8"	9 3/8"

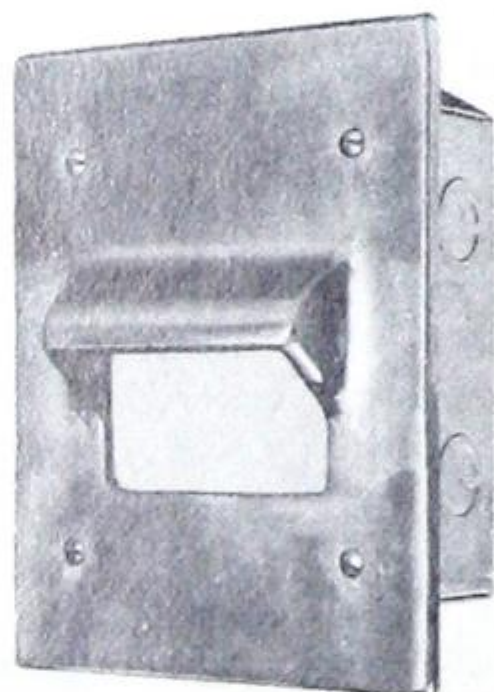

No. L-68

LOUVER LIGHTS
Amalgamated Louver Lights

The general design and polished aluminum finish of the L-68 Louver Light presents an appearance which harmonizes successfully with most interior decorations. The cover plate is a heavy aluminum casting with a single louver, the light being diffused through a flashed opal glass. This unit will be found ideally suited to such applications as theatre aisle lights, night and corridor lights for hospitals, hotels and insitutions; night lights for nurseries and bedrooms in private residences; and lighting of stairways, landings, etc.

Catalogue No.	Lamp Watts	Socket	Dimensions				
			Face Plate		Recessed Box		
			Height	Width	Height	Width	Depth
L68	25	Medium	7 3/4"	6"	6 3/16"	4 1/2"	3 1/16"



LOUVER LIGHTS Amalgamated Louver Lights

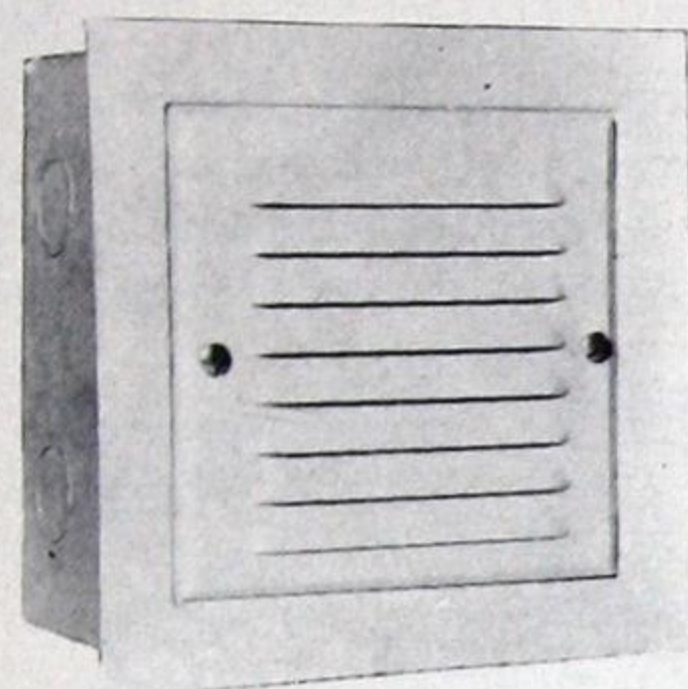

No. L-67

This unit is small in size, neat in appearance and consists of a sheet metal plaster plate, louver plate and box.

The louver plate and plaster plate are finished in white enamel, and the box is electro galvanized, and aluminized inside.

The louver plate is easily detachable for relamping.

This unit will be found ideally suited to such applications as theatre aisle lights, night and corridor lights for hospitals, hotels and institutions; night lights for nurseries and bedrooms in private residences; and the lighting of stairways, landings, etc.

Catalogue No.	Lamp Watts	Socket	Dimensions				
			Recessed Box			Face Plate	
			Height	Width	Depth	Height	Width
L 67	25	Medium	6 $\frac{1}{8}$ "	6 $\frac{3}{16}$ "	3"	6 $\frac{1}{16}$ "	6 $\frac{1}{16}$ "

Amalgamated Special Hospital Louver Lights or Night Lights

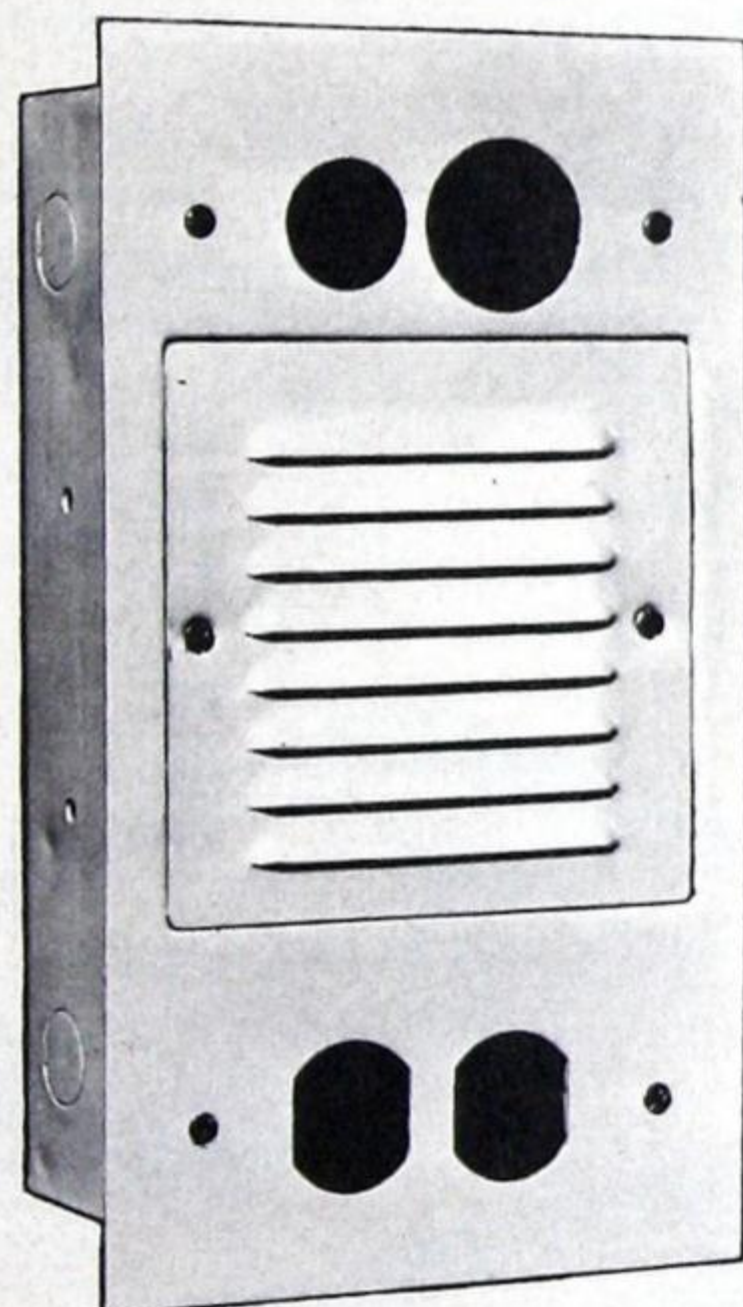

No. 114649-4

Designed to provide an adequate source of night light in hospital corridors, wards and nurseries, these units also help to centralize the location of the various electrical outlets often required in hospitals.

Each unit includes a porcelain receptacle which will accommodate a 25 watt incandescent lamp. Under the different catalogue numbers listed, provision is made for mounting either a nurse's call signal, a pilot light, a duplex receptacle, a telephone or radio receptacle or combinations of these. Special combinations not listed are available on application.

The units are manufactured from number 18 gauge steel and are finished in baked white enamel throughout. The trim and louver plate are attached to the box by means of chrome plated steel screws.

There are several types of nurse's call and pilot light, each requiring a slightly different mounting arrangement. When ordering night lights with provision for mounting a nurse's call, with or without pilot light, **be sure to state which make of nurse's call will be used.**

Catalogue No.	With Provision for Installing	Dimensions*	
		Recessed Box Ht.	Face Plate Ht.
114649-1	Night Light Receptacle Only.**	9 $\frac{15}{16}$ "	10 $\frac{15}{16}$ "
114649-2	Duplex Receptacle.	9 $\frac{15}{16}$ "	10 $\frac{15}{16}$ "
114649-3	Nurses Call and Duplex Receptacle.	9 $\frac{15}{16}$ "	10 $\frac{15}{16}$ "
114649-4	Pilot Light, Nurses Call, and Duplex Receptacle.	9 $\frac{15}{16}$ "	10 $\frac{15}{16}$ "
114649-5	Nurses Call, Telephone and Duplex Receptacles.	11 $\frac{7}{8}$ "	12 $\frac{7}{8}$ "
114649-6	Pilot Light, Nurses Call, Telephone and Duplex Receptacles.	11 $\frac{7}{8}$ "	12 $\frac{7}{8}$ "
114649-7	Nurses Call, Radio, Telephone and Duplex Receptacles.	13 $\frac{13}{16}$ "	14 $\frac{13}{16}$ "
114649-8	Pilot Light, Nurses Call, Radio, Telephone and Duplex Receptacles.	13 $\frac{13}{16}$ "	14 $\frac{13}{16}$ "

*Face Plate, Width 6 $\frac{1}{8}$ ". Recessed Box, Depth 2 $\frac{3}{16}$ ", Width 5 $\frac{1}{4}$ ".

**No. 114649-1 includes night light receptacle only. Includes no provision for mounting other equipment.

ENCLOSED RECESSED UNITS

Electrolier Square and Oblong Recessed Units

The recessed units shown on the following pages are of shallow depth for use in the maximum number of locations. The recessed box is finished in baked white enamel and the frame is brushed chrome. All the square units, with the exception of Nos. 263 and 283 are of a special hinged frame construction which allows the frame and glassware components to be instantly lowered for relamping and cleaning of the inside of the unit. The frame and glass may be removed and then snapped back into position without the use of tools. The frame is held securely in place by a special retaining spring action and no screws are required.

With the exception of No. 57A, standard boxes are supplied without reflectors. If reflectors are desired, they must be specified. All units are supplied with squeeze connector and 4½' No. 14AF wire.

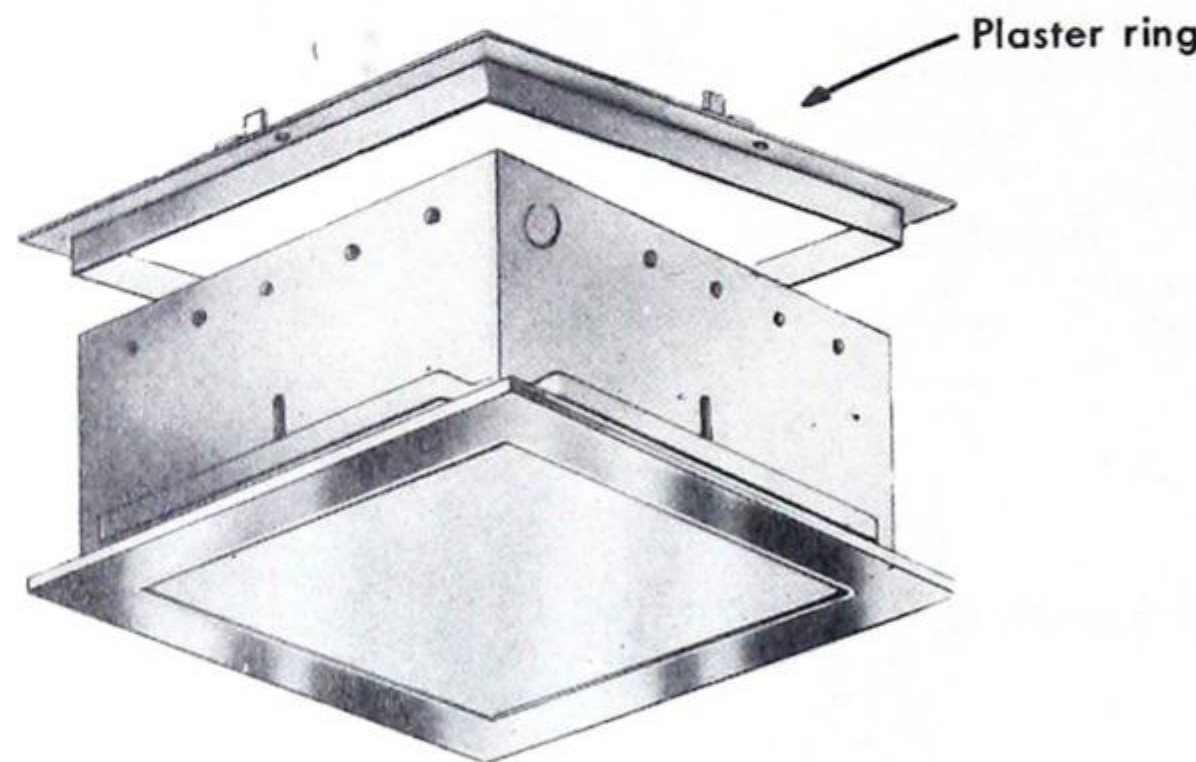

Nos. 43, 45, 46, 47

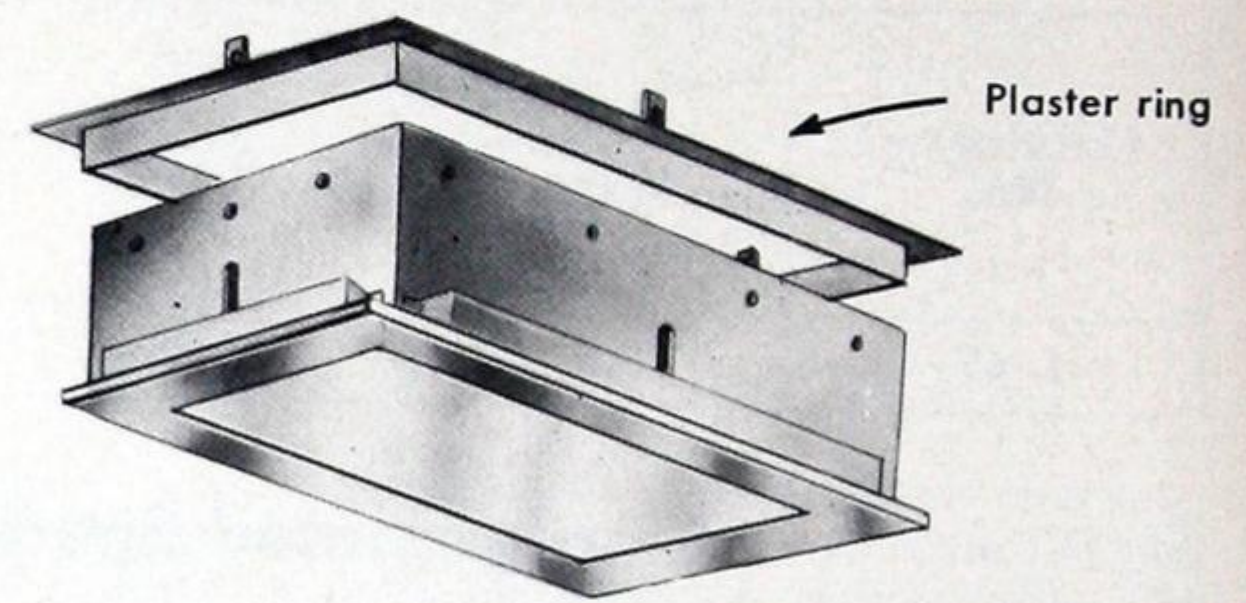

Nos. 48, 49, 49A

Catalogue No.	Lamp Watts	Box Opening Size	Frame Size	Depth	Glass* Size	Plaster Ring** Catalogue No.
43	1 x 60	10½" x 10½"	11½" x 11½"	4½"	8" x 8"	PR-43 PR-45 PR-46 PR-47 PR-48
45	1 x 100	12" x 12"	13" x 13"	5¾"	10" x 10"	
46	1 x 150	13" x 13"	14" x 14"	6¾"	11" x 11"	
47	1 x 200	14" x 14"	15" x 15"	7"	12" x 12"	
48	1 x 40	8" x 10"	9" x 11"	4½"	6" x 8"	
49	1 x 60	8" x 12"	9" x 13"	5¼"	6" x 10"	PR-49
49A	2 x 60	9" x 19¼"	10" x 20¼"	6"	7" x 17¼"	PR-49A

*Albalite glass panels. **Specify separately.

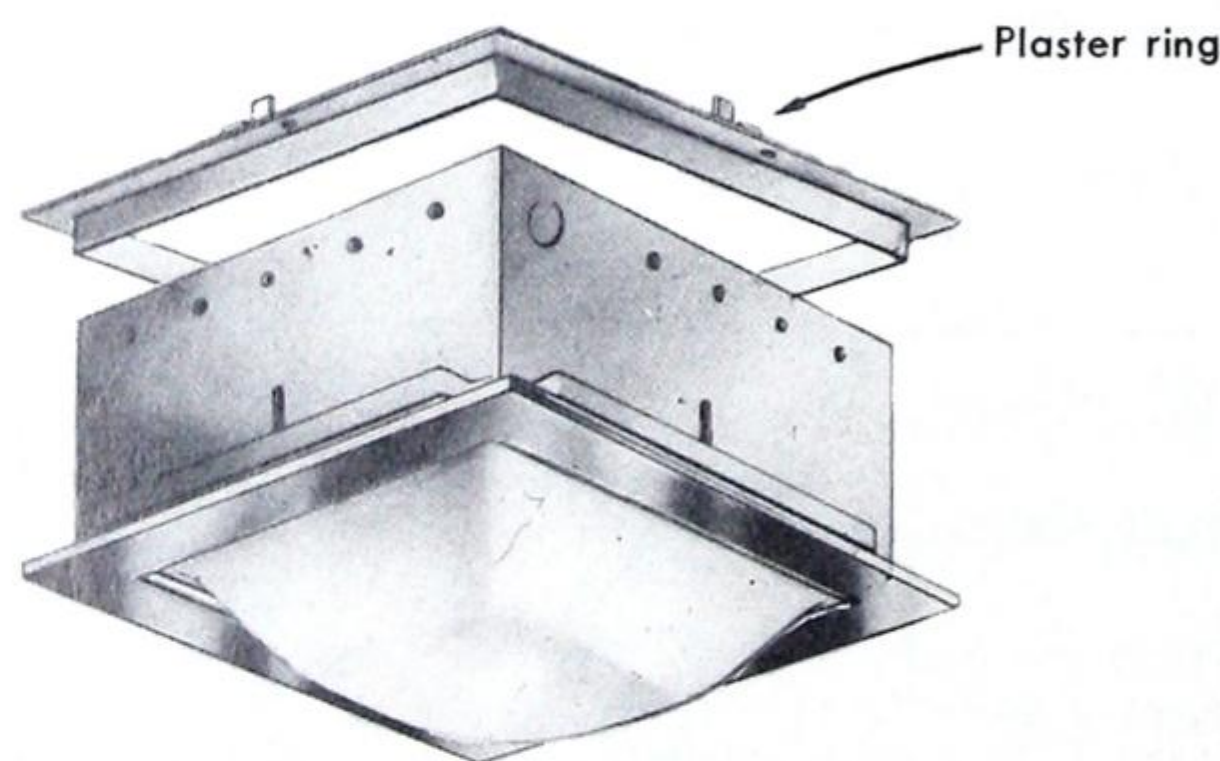

Nos. 83, 85, 87

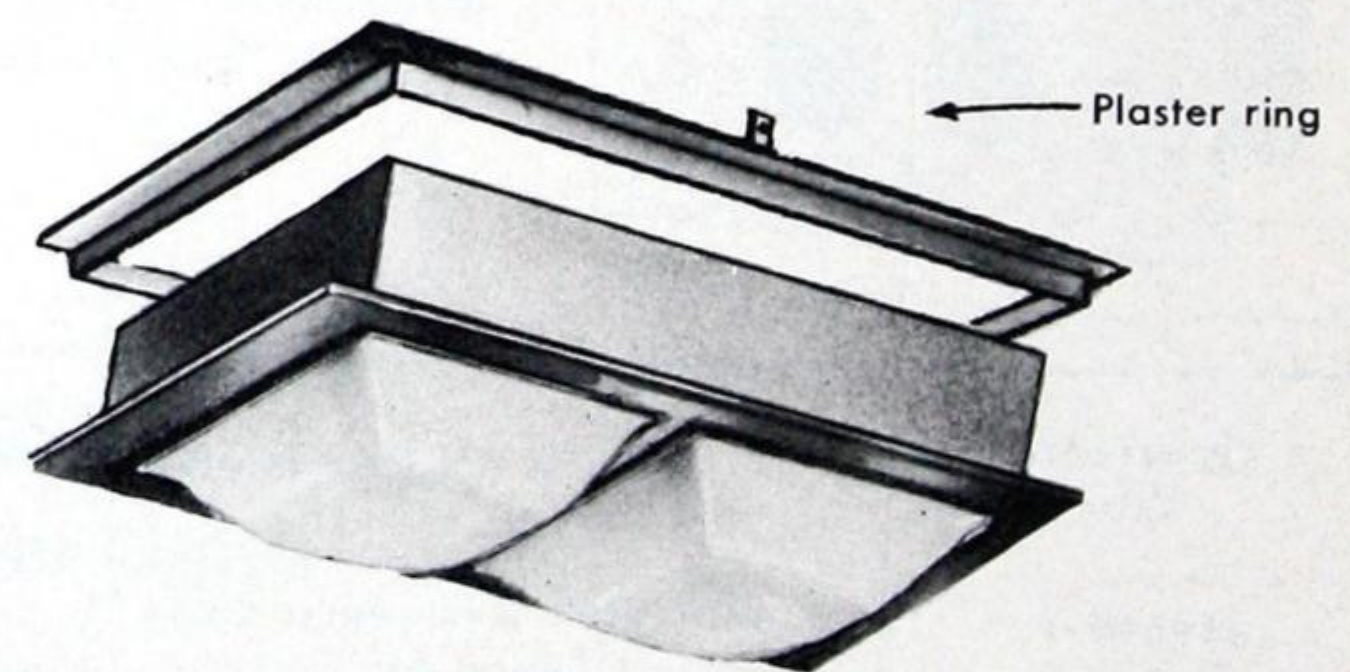

No. 283

Catalogue No.	Lamp Watts	Box Opening Size	Frame Size	Depth	Glass* Size	Plaster Ring** Catalogue No.
83	1 x 60	10½" x 10½"	11½" x 11½"	4½"	8" x 8"	PR-43 PR-45 PR-47
85	1 x 100	12" x 12"	13" x 13"	5¾"	10" x 10"	
87	1 x 200	14" x 14"	15" x 15"	7"	12" x 12"	
283	2 x 60	9¼" x 17"	10¾" x 18½"	4¾"	8" x 8"	PR-283

*Opal ceramic dropped panels. **Specify separately.



ENCLOSED RECESSED UNITS

Electrolier Square and Oblong Recessed Units

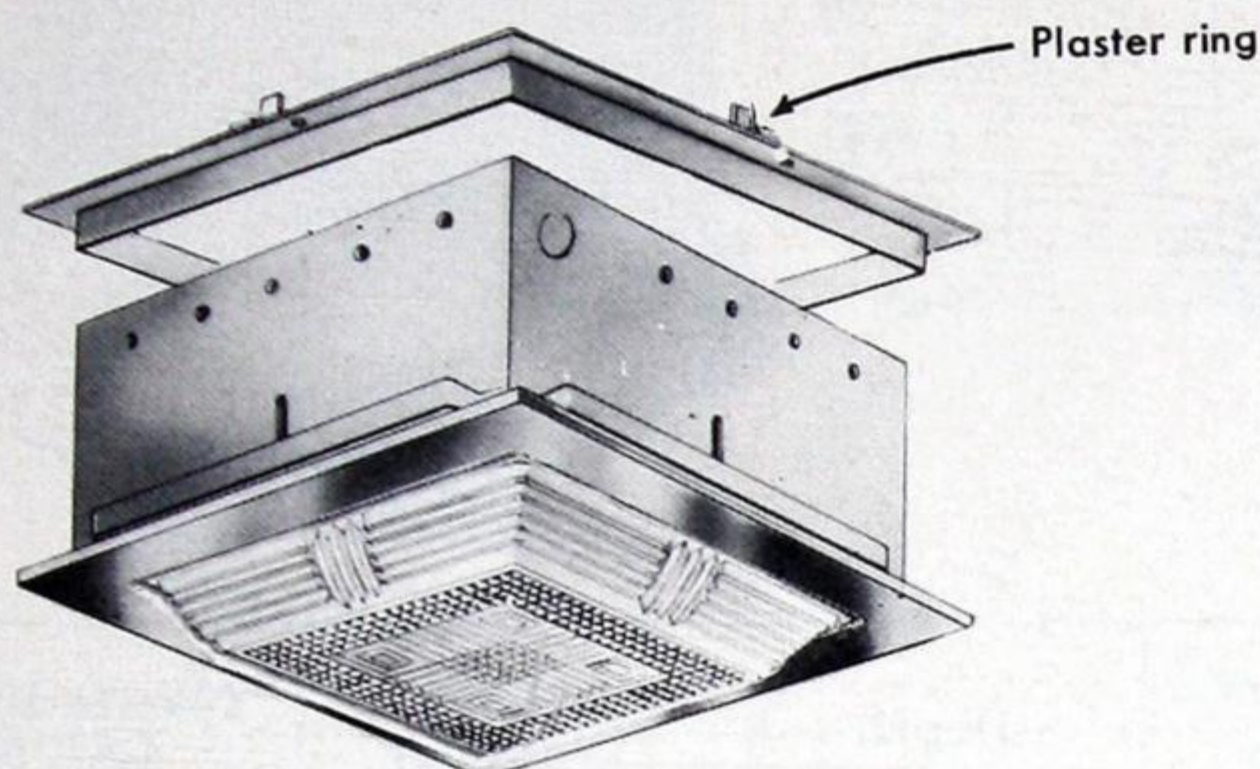

Nos. 63, 65, 67

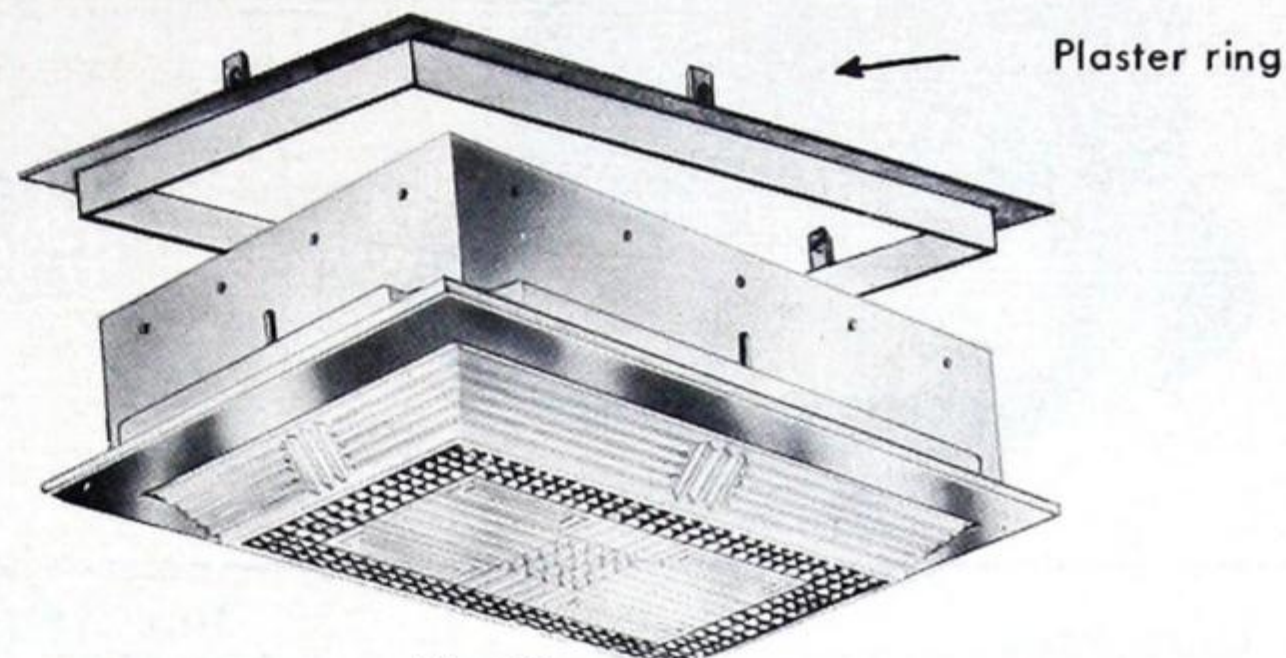

No. 69

Catalogue No.	Lamp Watts	Box Opening Size	Frame Size	Depth	Glass* Size	Plaster Ring** Catalogue No.
63	1 x 60	10½" x 10½"	11½" x 11½"	4½"	8" x 8"	PR-43
65	1 x 100	12" x 12"	13" x 13"	5¾"	10" x 10"	PR-45
67	1 x 200	14" x 14"	15" x 15"	7"	12" x 12"	PR-47
69	1 x 60	8" x 12"	9" x 13"	5¼"	6" x 10"	PR-49

*Satin and Crystal dropped lens.

**Specify separately.

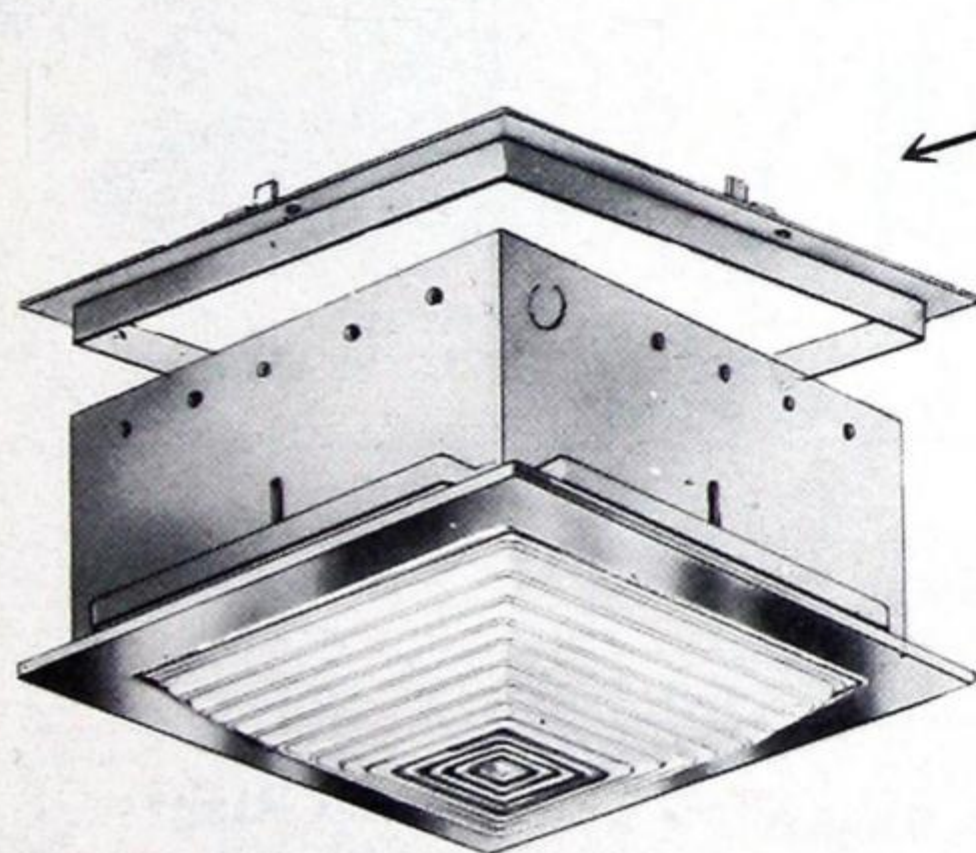

Nos. 74, 76, 77

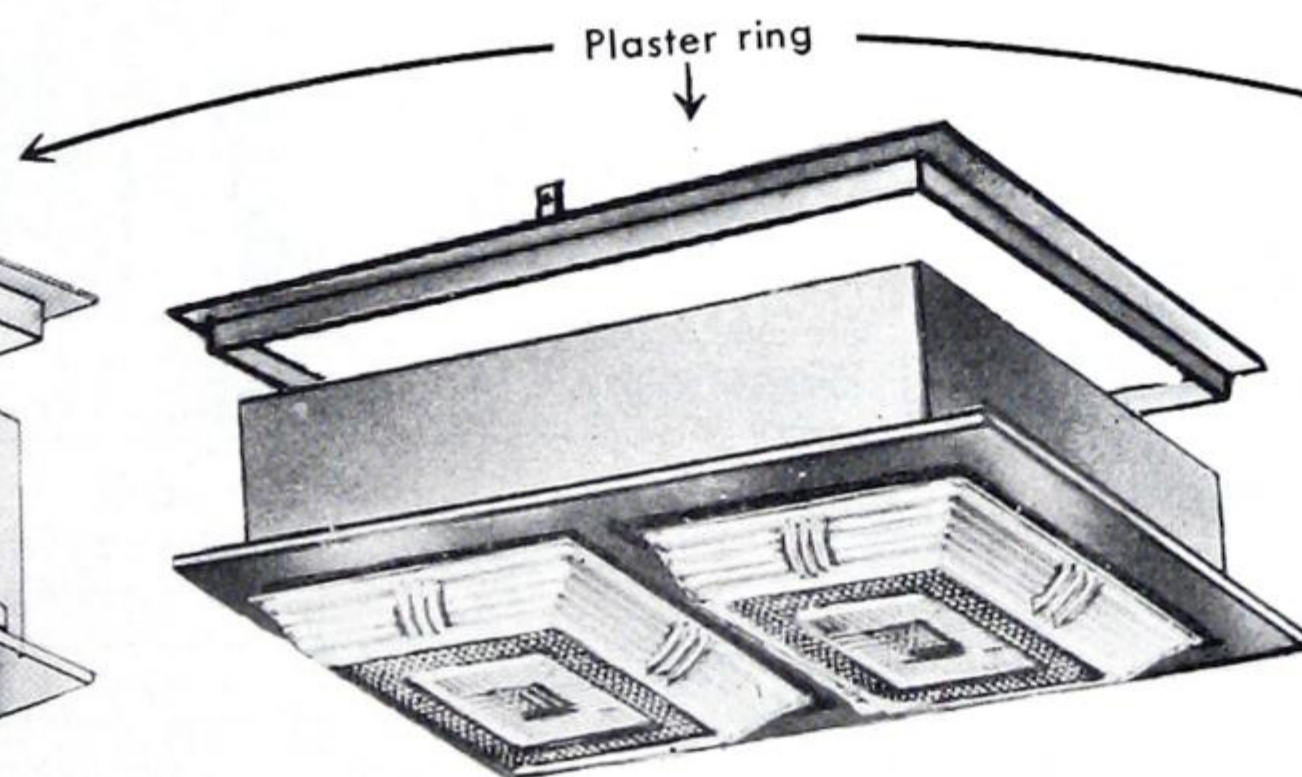

No. 263

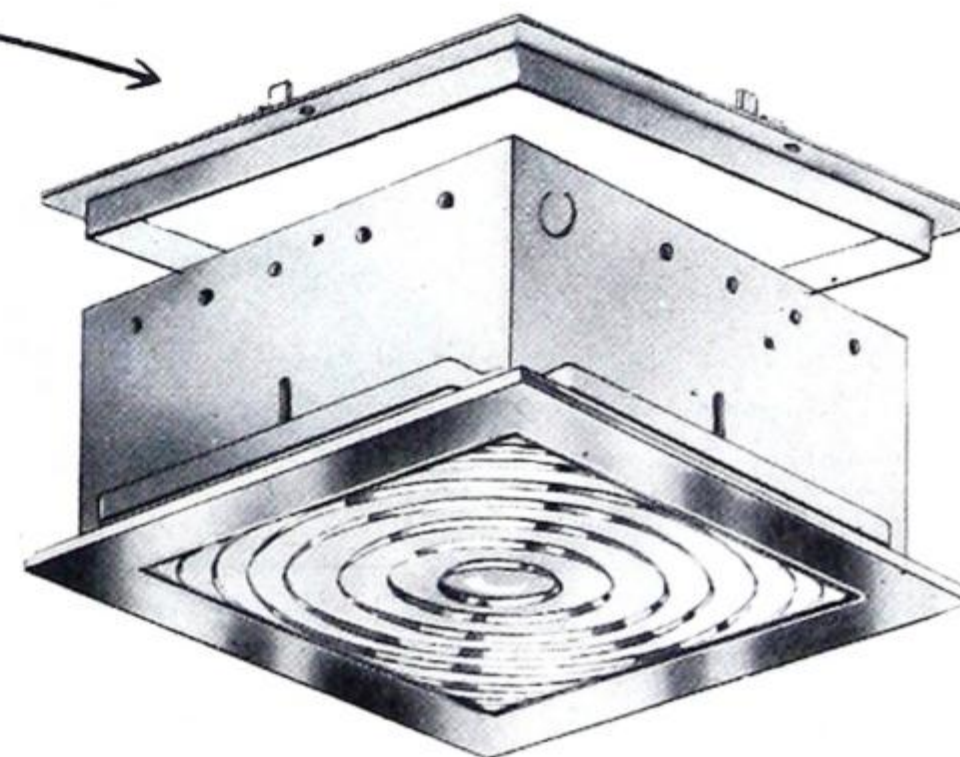

Nos. 53, 57, 57A

Catalogue No.	Lamp Watts	Box Opening Size	Frame Size	Depth	Glass* Size	Plaster Ring† Catalogue No.
53	1 x 60	10½" x 10½"	11½" x 11½"	4½"	8" x 8"	PR-43
57	1 x 200	14" x 14"	15" x 15"	7"	12" x 12"	PR-47
57A**	1 x 300	14" x 14"	15" x 15"	11½"	12" x 12"	PR-47
74	1 x 60	10½" x 10½"	11½" x 11½"	4½"	8½" x 8½"	PR-43
76	1 x 150	13" x 13"	14" x 14"	6¾"	11" x 11"	PR-46
77	1 x 200	14" x 14"	15" x 15"	7"	12" x 12"	PR-47
263	2 x 60	9¼" x 17"	10¾" x 18½"	4¾"	8" x 8"	PR-283

*Nos. 74, 76, 77—with Ribbed Moulded Dropped Lens. No. 263 with two Satin and Crystal Dropped Lens. Nos. 53, 57, 57A—with Fresnel Lenslite Panels. **With Built In Reflector. †Specify separately.

COMMERCIAL LIGHTING
INCANDESCENT



ENCLOSED RECESSED AND SURFACE UNITS
Electrolier Round Recessed Units

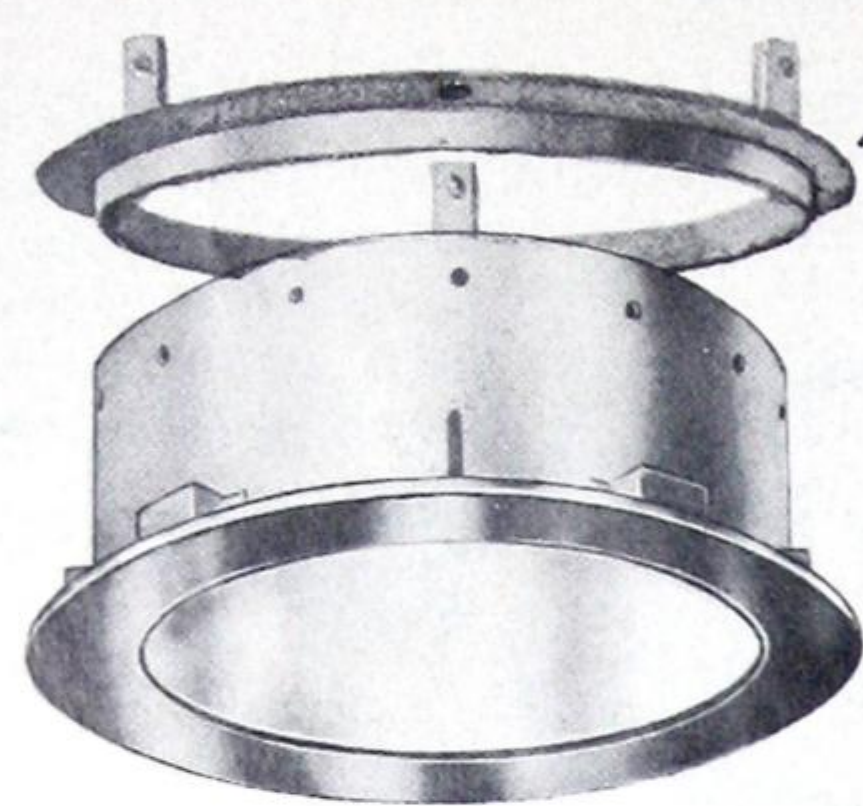

Nos. 10, 11, 12



No. 35

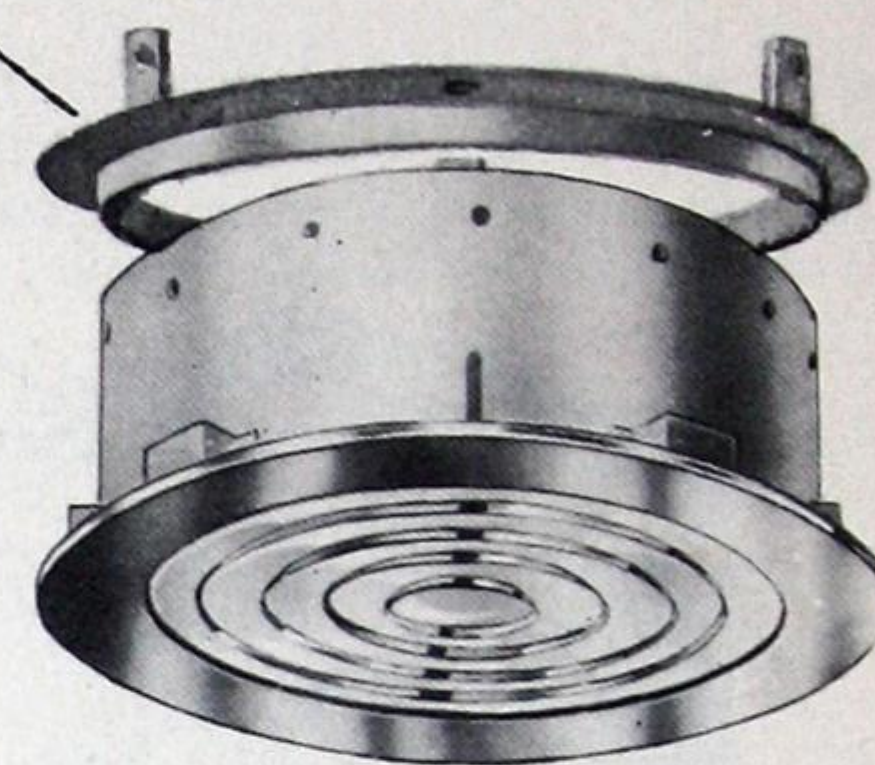

Nos. 20, 21, 22

Catalogue No.	Lamp Watts	Box Opening Diameter	Frame Diameter	Depth	Glass* Diameter	Plaster Rings** Cat. No.
10	1 x 40	8 1/4"	9 1/4"	4 3/4"	5 3/4"	PR-10
11	1 x 60	9 3/4"	10 3/4"	5 1/8"	8 1/4"	PR-11
12	1 x 100	11 1/2"	12 1/2"	5 3/4"	9 7/8"	PR-12
20	1 x 40	8 1/4"	9 1/4"	4 3/4"	5 3/4"	PR-10
21	1 x 60	9 3/4"	10 3/4"	5 1/8"	8 1/4"	PR-11
22	1 x 100	11 1/2"	12 1/2"	5 3/4"	9 7/8"	PR-12
35	1 x 40	4 3/4"	7 1/2"	5"		
Shower Light with dropped Satin etched glass (not hinged)						

*No. 10 Series with Albalite Glass. No. 20 Series with Fresnel Lenslite.

**Specify separately.

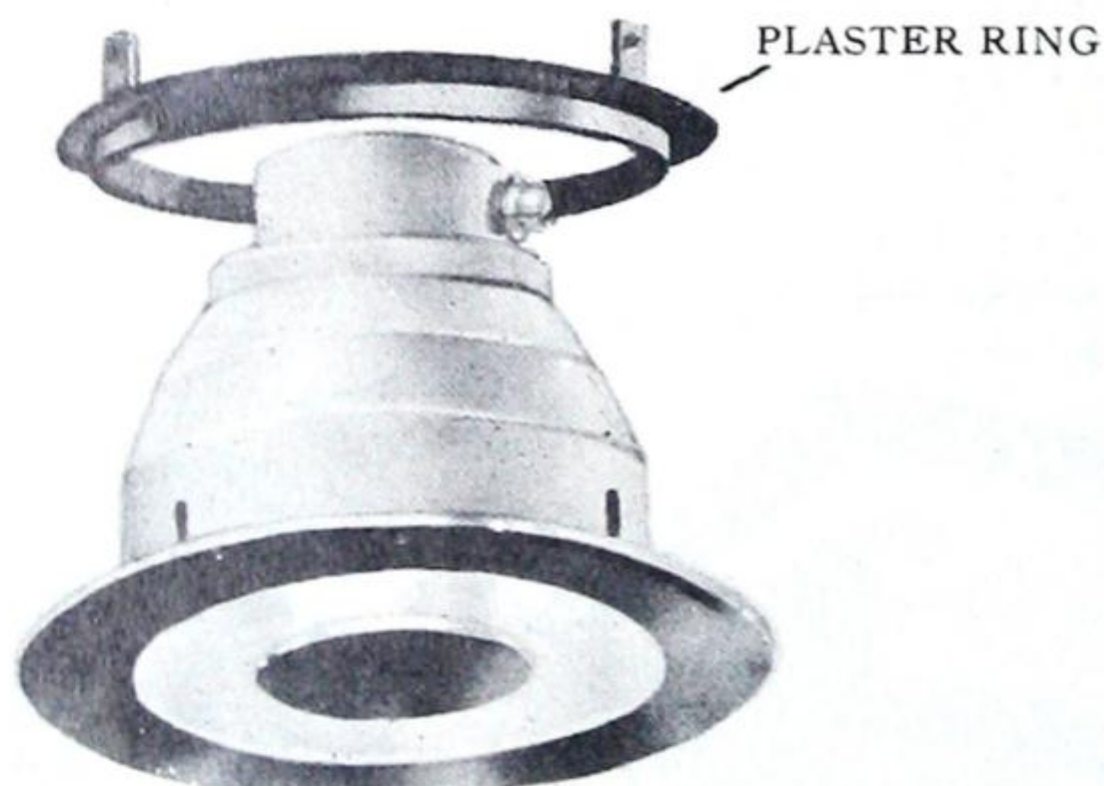

Nos. RL-790, RL-791

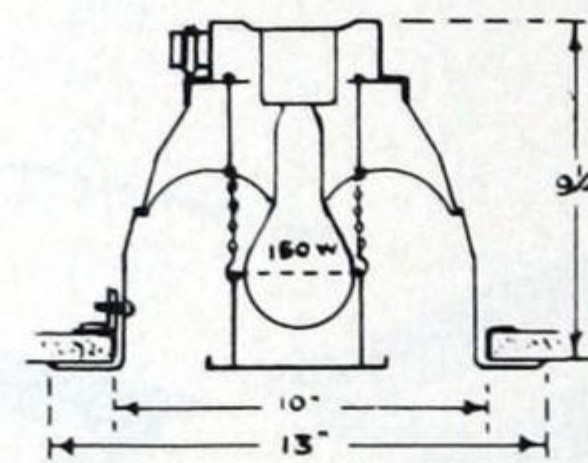

SECTIONAL VIEW No. RL-790

Ring Lights—For use with silver bowl lamps—Polished Aluminum Reflector.

Catalogue No.	Lamp Watts	Box Opening Diameter	Frame Diameter	Depth	Plaster Ring* Cat. No.
RL-790	1 x 100	9 1/4"	12 1/4"	8 1/2"	PR-790
RL-791	1 x 150	10 1/4"	13 3/4"	9"	PR-791

*Specify separately.

Electrolier Round Surface Units



Nos. 31042-142

Catalogue No.	Lamp Watts	Dia.	Depth	Glass Dia.
57152*	2 x 40	9"	4"	8"
57252*	2 x 60	11"	4 1/2"	10"
57253*	3 x 60	13"	5 1/4"	12"
57353*	3 x 100	15"	5 3/4"	14"
31042**	2 x 40	9"	4 1/2"	8"
31142**	2 x 60	11"	5"	10"

*Opal Glass Bowl.

**Opal Glass Bowl with clear ribbed bottom.

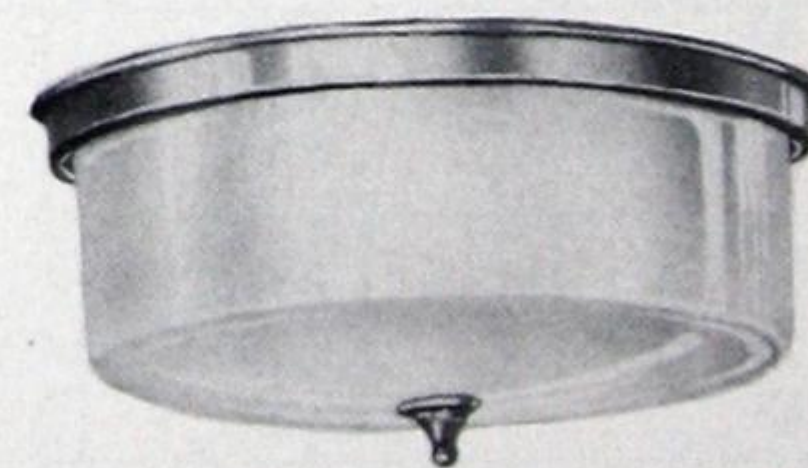

Nos. 57152-252-253-353



DISPLAY SPOTLIGHTS AND DOWN LIGHTS

Electrolier Swivel Spotlights

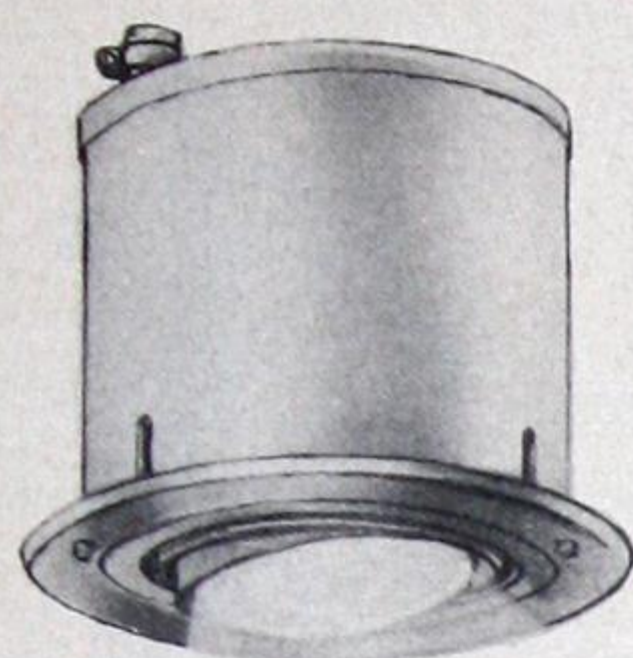

No. P-150

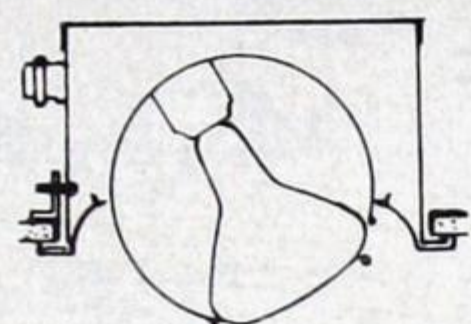

No. S-700 WITH R-40 LAMP



No. S-700 WITH PAR 38 LAMP AND No. L-700 LOUVER



PLASTER RING

No. S-700



PLASTER RING



No. L-700

Swivel Spotlight

Catalogue*† No.	Lamp	Box Opening Diameter	Frame Diameter	Depth	Catalogue Nos.**	
					Louver	Plaster Ring
P-150	150W R40	9 3/4"	10 3/4"	9 1/2"	—	PR-150
S-700	150W R40	10 3/8"	11 1/4"	6"	—	PR-700
	150W PAR38	10 3/8"	11 1/4"	6"	L-700†	PR-700

*Swivels 35° in all directions. specify separately.

**Specify separately.

†May also be used with colour filter Cat No. S-3—red, green, amber.

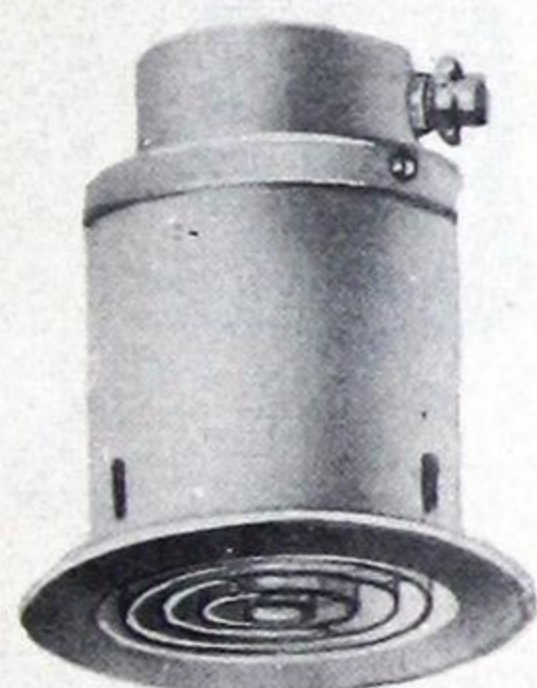

P-130 SERIES
P-140 SERIES

Electrolier Louver and Pinpoint Down Lights

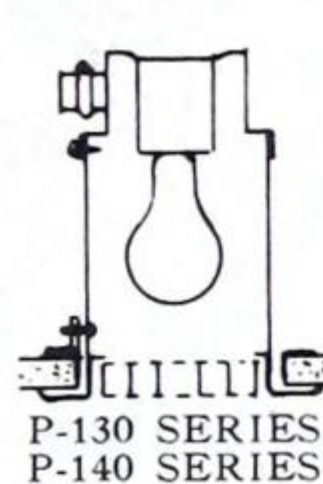

P-130 SERIES
P-140 SERIES

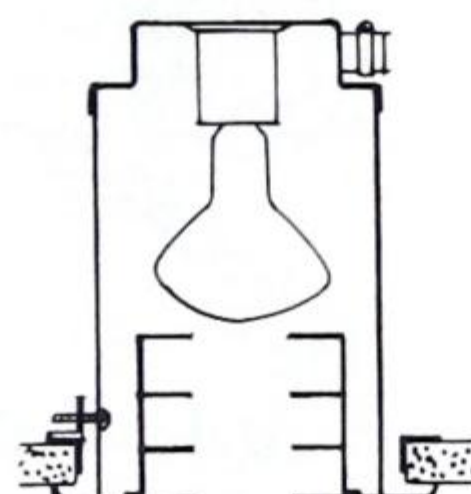

Nos. P-151-2-3

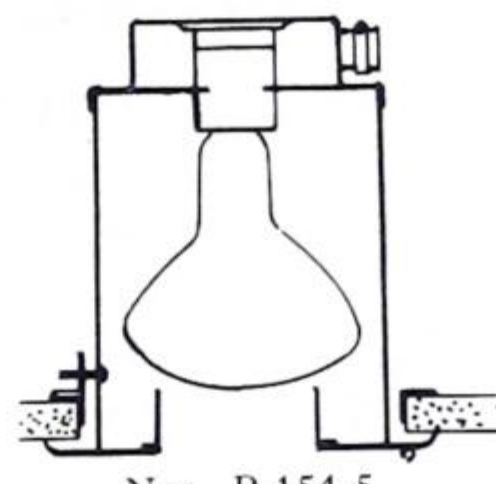

Nos. P-154-5

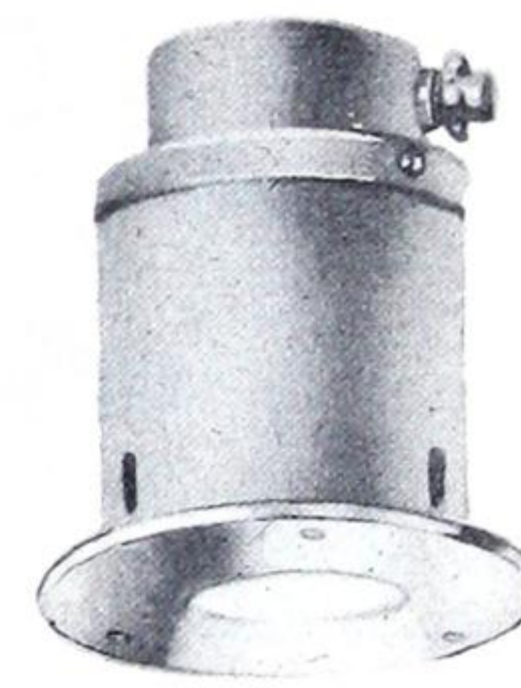

Nos. P-151-2-3-4-5

Recessed Louvered Down Lights

Catalogue* No.	Lamp	Box Opening Diameter	Frame Diameter	Depth	Bare Shielding Angle	Catalogue Nos.**	
						Louver	Plaster Ring
P-130	75W R30	5 1/8"	7"	6 1/8"	0°	—	PR-130
P-131	75W R30	5 1/8"	7"	8 1/8"	30°	L-130	PR-130
P-132	75W R30	5 1/8"	7"	9 3/4"	45°	L-130	PR-130
P-140	150W R40	6 1/2"	8"	7 1/2"	0°	—	PR-140
P-141	150W R40	6 1/2"	8"	8 3/8"	15°	—	PR-140
P-142	150W R40	6 1/2"	8"	9 1/8"	22°	L-140	PR-140
P-143	150W R40	6 1/2"	8"	9 3/4"	30°	L-140	PR-140
P-144	150W R40	6 1/2"	8"	12"	45°	L-140	PR-140

*Satin Aluminum trim.

**Specify separately.

Recessed Pinpoint Down Lights

Catalogue* No.	Lamp	Box Opening Diameter	Frame Diameter	Depth	Aperture Diameter	Plaster Ring** Catalogue Nos.
P-151	150W R40	9 3/4"	10 3/4"	11 1/2"	5 1/4"	PR-150
P-152	75W R30	6 1/2"	8"	10"	3 1/4"	PR-140
P-153	75W R30	6 1/2"	8"	10"	2"	PR-140
P-154	150W R40	9 3/4"	10 3/4"	8 1/2"	3 1/4"	PR-150
P-155	75W R30	6 1/2"	8"	7 1/4"	2"	PR-140

*Baked White Enamel.

**Specify separately.



DOWN LIGHTS
Recessed Down Lights

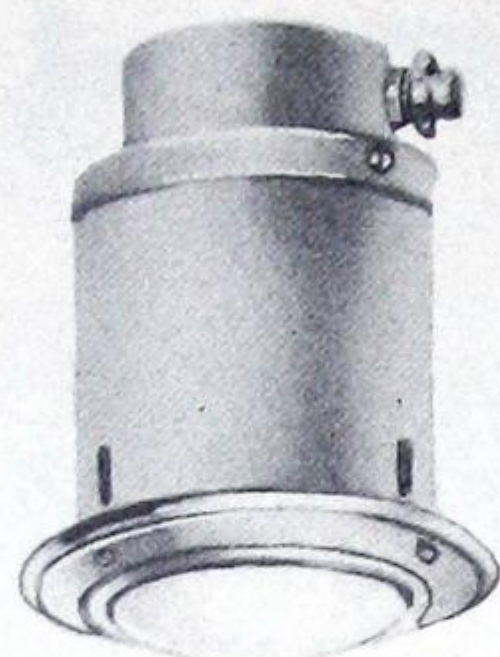

No. P-156

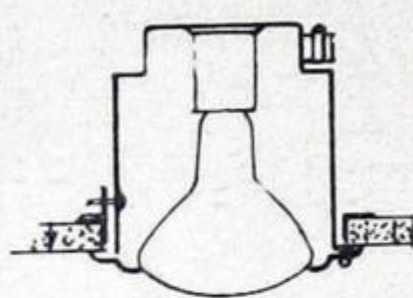

No. P-156

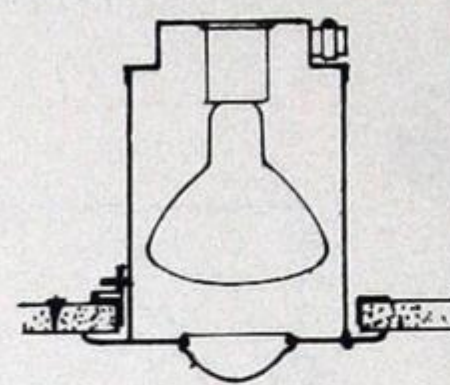

No. P-157

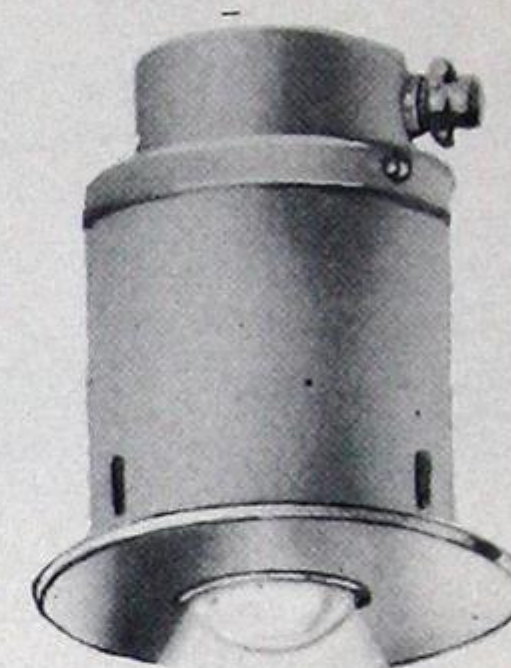

No. P-157



PLASTER RING

Catalogue No.*	Lamp	Box Opening Diameter	Frame Diameter	Depth	Plaster Ring** Catalogue No.
P-156	150W R40	6 1/2"	7 5/8"	6 3/8"	PR-140
P-157	150W R40	9 3/4"	10 3/4"	8 1/2"	PR-150

*Complete with 4 1/2' No. 14 AF Wire.

**Specify separately.

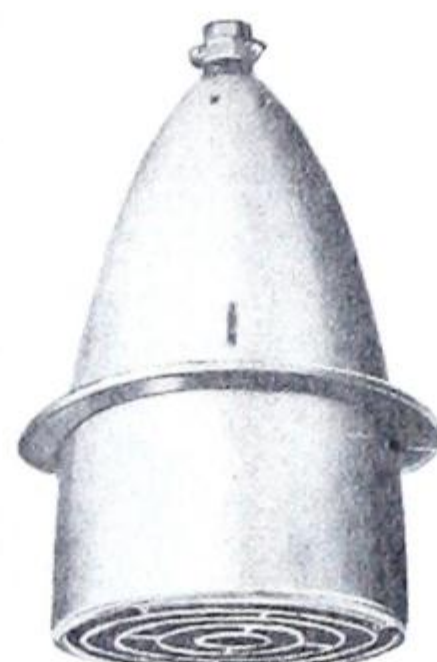

No. P-158



PLASTER RING



No. P-159

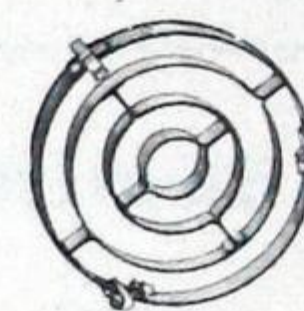

No. L-140



No. P-160

Semi-Recessed and Surface Down Lights

Catalogue No.	Lamp	Box Opening Diameter	Frame Diameter	Recessed Depth	Catalogue No.**	
					Louver	Plaster Ring
P-158*	150W R40	6 1/2"	8"	6 1/4"	L-140	PR-140
		Diameter	Depth	Mounting		
P-159	75W R30	5 1/2"	8 1/2"	Outlet Box	—	—
P-160	150W R40	6 1/4"	9"	Outlet Box	L-140	—

*Complete with 4 1/2' No. 14 AF Wire.

**Specify separately.

Adjustable Swivelite Units

Swivelites are furnished as completely assembled units in any of the arrangements shown on following page. Because of their unique principle, now, for the first time, hoods can be put on or taken off, by merely unscrewing porcelain end of socket.

Basic units such as hoods, cluster canopies, rigid pipes, etc., are all interchangeable — giving the user unheard-of flexibility and adaptability in his lighting arrangements. Standard hoods can be interchanged with midget hoods!

Though Swivelites come completely assembled to your specifications, this interchangeability is a plus value, ready to pay off when future needs call for changed lighting arrangements. Finished in baked satin aluminum, these units are for use with R-40, PAR-38 or R-30 Spot or Flood Lamps.

Swivelite is the new double jointed swivel. It has double universal joints, two in each Swivelite to provide a greater angle adjustment and permits universal coverage with a full 360° horizontal placement and 180° vertical placement.

Stays just at angle desired regardless of age, wear, vibration, number of adjustments or weight of bulb. Friction joint is locked into housing under spring tension. Wires cannot twist because of four twist-proof locking nibs two in each ball. New, improved ventilating ports carry off excess heat, provide cooler operation near the lamp socket. Cooler burning helps lamps last longer, reduces tendency to loosen bases.



DISPLAY SPOTLIGHTS



No. S-10



No. S-12, 13



No. S-11

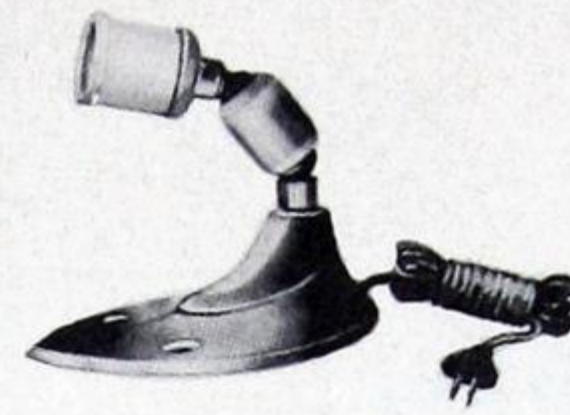

No. S-4



No. S-21

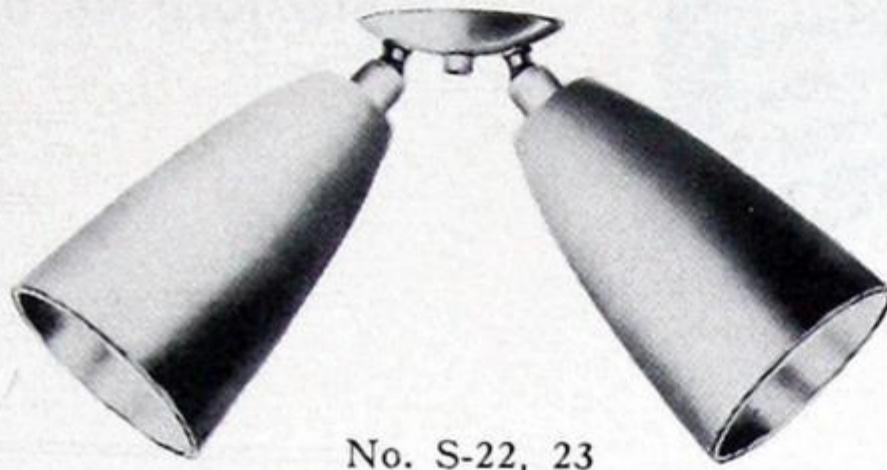

No. S-22, 23



No. S-21-A

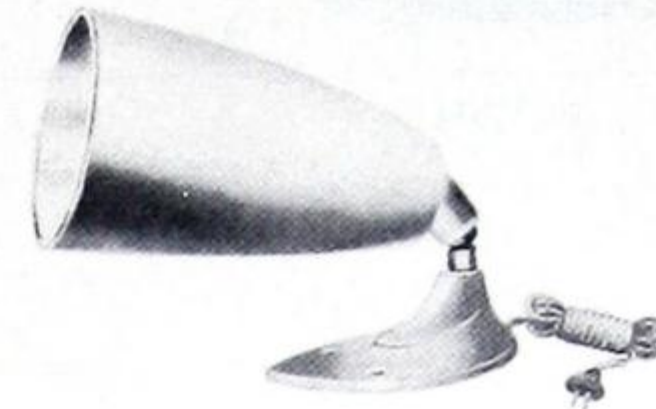

No. S-5

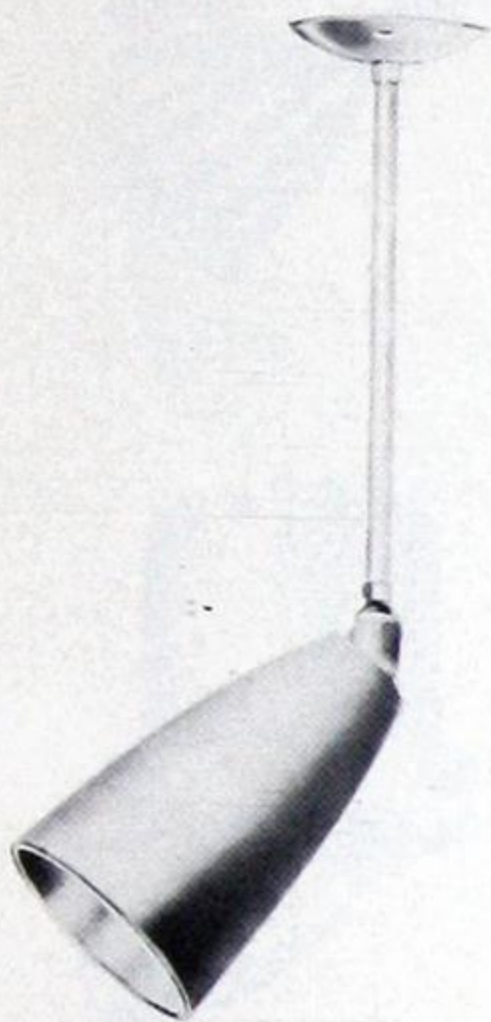

No. S-31



No. S-32, 33



No. S-6, 7



No. S-31-A



No. S-2



No. S-34, 35

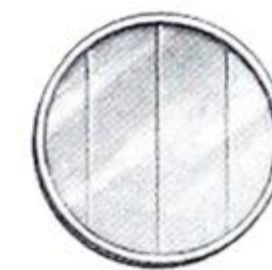

No. S-3

Cat. No.	Description	Cat. No.	Description
S-2	Louver to take No. S-3 Colour Filter.	S-21	One light, on canopy, with hood.
S-3	Colour Filter, Red, Blue, Green, or Amber	S-21A	One light, on canopy, rigid.
S-4	Portable less hood.	S-22	Two lights, on canopy, with hood.
S-5	Portable with hood.	S-23	Three lights, on canopy, with hood.
S-6	One light, with curved arm 12" extension.	S-31	One light, rod suspension.
S-7	One light, with curved arm 24" extension.	S-31A	One light, rod suspension, rigid.
S-10	Screw in adapter socket.	S-32	Two lights, rod suspension.
S-11	One light, on canopy, less hood.	S-33	Three lights, rod suspension.
S-12	Two lights, on canopy, less hood.	S-34	Clip colour filter holder for R-40 Lamp.
S-13	Three lights, on canopy, less hood.	S-35	Clip colour filter holder for PAR-38 Lamp.

*For smaller bulb as illustrated above for 75W R-30 lamp, specify by using prefix SS to above numbers.
 NOTE—Standard length of rod supplied is 12". Special lengths available if specified.

Swivelite Units—For use with R-40, PAR-38, or R-30* Spot or Flood Lamps.



DISPLAY SPOTLIGHTS

Swivelier "Gyro-Lite" and "Par-Beam-Lite"

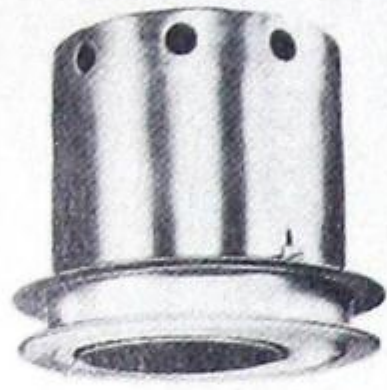

FLUSH

"Gyro-Lite"

Cat. No. 725
Louver No. 726



"Par-Beam-Lite"

Cat. No. 656
Louver No. 657
Adapter Ring No. 658



60°



15°

The Swivelier Gyro-Lite and Par-Beam-Lite are universally adjustable recessed lighting units for ceiling, floor or wall installations. They provide 90° vertical adjustment and 360° horizontal adjustment, thus allowing the light to follow a display wherever it may be moved. The patented sockets have no wing nuts or set screws and will not work loose, permitting the unit to stay put at any angle.

The Gyro-Lite utilizes 150-watt PAR-38 or 75-watt R-30 lamps, while the Par-Beam-Lite essentially designed for high ceiling applications, uses the 200 watt PAR-46 (side prong) lamp.

The units are supplied with plaster ring and are as simple to install as a non-adjustable recessed unit.

Construction is of heavy gauge aluminum with shade and exterior finished in brushed satin aluminum.



75°

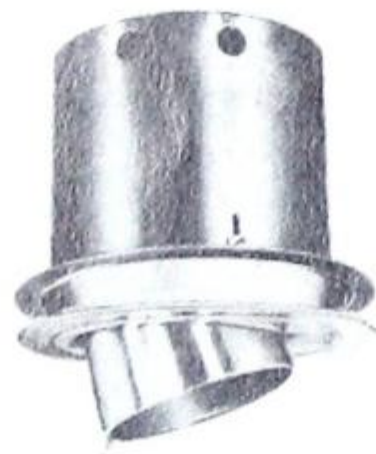

30°

Specifications

"Gyro-Lite"

- 4 ft. Greenfield. Right Angle Connector. Housing Ventilated.
- Heavy Gauge Aluminum Housing and Parts
- Interior has Dark, Non-Reflecting Surface.
- Approved Leads with Asbestos Sleeves.
- Swivelier Patented Sockets (90° Vertical).
- 2 1/4" long Slots—allows for variation in construction.
- Sturdy Metal Plaster Ring.
- Ring Rotates within Housing (360° Horizontal)
- Visible Exterior Parts—Brushed Satin Finish, Infra-Baked Clear Lacquer.
- Shade Ventilated, Baffled to Prevent Light Spill.

"Par-Beam-Lite"

- Right Angle Connector, Anti-Short Bushings.
- 5' AF Leads, 4' Greenfield.
- Housing and Shade Ventilation.
- Heavy Gauge Aluminum Housing.
- PAR 46 Lamp Receptacle.
- 2 1/8" Slots—Allows for variations in ceiling construction.
- Steel Plaster Ring with Threaded Inserts.
- Shade and Exterior—Brushed Satin Aluminum Finish.
- Interior—Dark, Non-Reflecting Finish.
- Shade Pull—Permits adjustment from floor, with pole.



90°



45°



360° HORIZONTAL



LOUVER

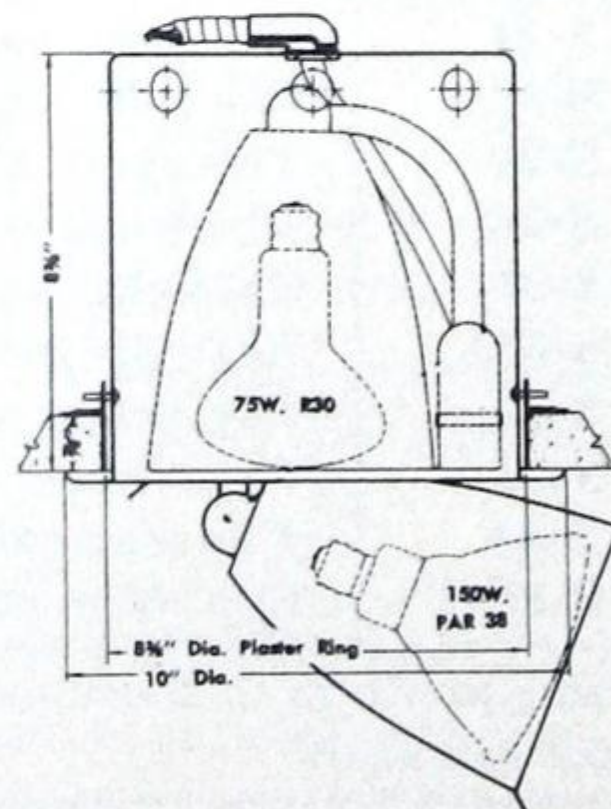

"GYRO-LITE"

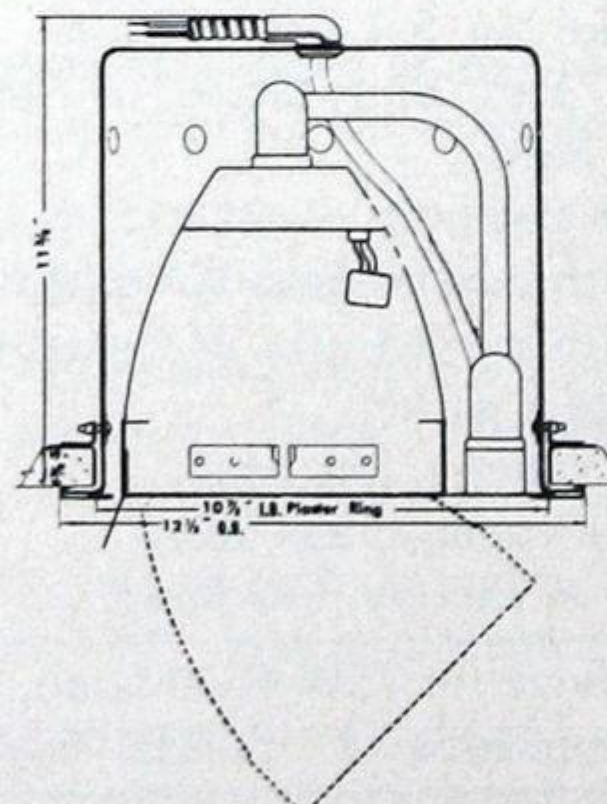

"PAR-BEAM-LITE"



ADAPTER FOR PAR 46 LAMP



LIGHTING GLASSWARE

CORNING—"KEYSTONE"

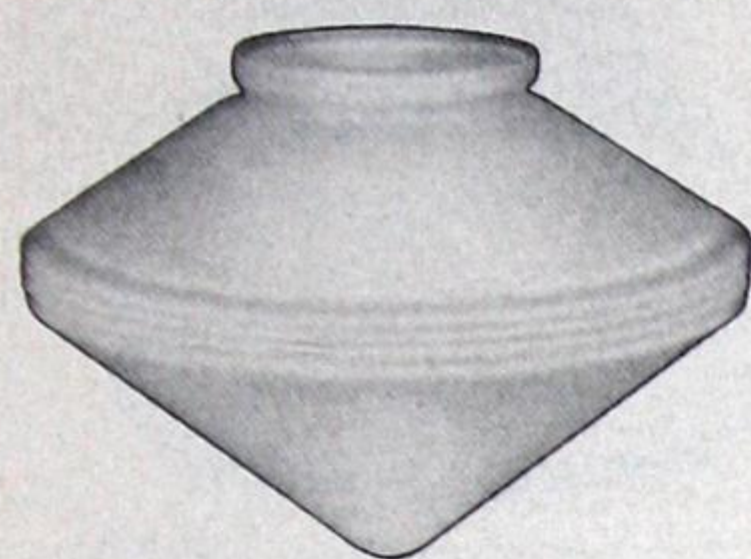

"KEYSTONE"

Catalogue No.	Lamp Watts	Diameter	Depth	Fitter	Std. Pkg.
816660	60	9 $\frac{1}{4}$ "	6 $\frac{9}{16}$ "	4"	8
816670	100	12 $\frac{1}{4}$ "	8 $\frac{3}{16}$ "	6"	4
816680	150	14 $\frac{1}{4}$ "	9 $\frac{3}{4}$ "	6"	2
816690	200	16 $\frac{1}{4}$ "	10 $\frac{5}{8}$ "	6"	2
816700	300	18 $\frac{1}{4}$ "	12 $\frac{7}{16}$ "	6"	1

CORNING—"SEVILLE"



"SEVILLE"

Catalogue No.	Lamp Watts	Diameter	Depth	Fitter	Std. Pkg.
810619	60	8 $\frac{1}{8}$ "	5 $\frac{9}{16}$ "	4"	12
813160	60	10"	6 $\frac{1}{2}$ "	4"	8
813170	100	12"	7 $\frac{3}{4}$ "	6"	4
813180	100	12"	7 $\frac{3}{4}$ "	4"	4
813190	150	14"	9"	6"	3
813200	200	16"	10 $\frac{1}{4}$ "	6"	2
813220	300	18"	11 $\frac{3}{8}$ "	6"	1

CORNING—BALL GLOBES



BALL GLOBE

Catalogue No.	Diameter	Depth	Fitter	Std. Pkg.
823200	6"	6"	3 $\frac{1}{4}$ "	24
823220	8"	8"	4"	12
800080	10"	10"	4"	8
800060	10"	10"	5"	8
800070	10"	10"	6"	8
800020	12"	12"	6"	2
800190	12"	12"	8"	2
800090	14"	14"	6"	1
800120	14"	14"	7"	1
800140	14"	14"	8"	1
800200	16"	16"	6"	1
800040	16"	16"	8"	1
800030	18"	18"	8"	1
800170	18"	17 $\frac{5}{16}$ "	10"	1

GLEASON-TIEBOUT—"RANGER"



"RANGER"

Catalogue No.	Lamp Watts	Diameter	Depth	Fitter	Std. Pkg.
12180LSB	200-300	16 $\frac{1}{4}$ "	8 $\frac{1}{2}$ "	6"	2
12180LSB	300-500	18 $\frac{1}{4}$ "	9 $\frac{1}{8}$ "	6"	2

COMMERCIAL LIGHTING
INCANDESCENT

LIGHTING GLASSWARE
Webber Glassware



Nos. 1806-08

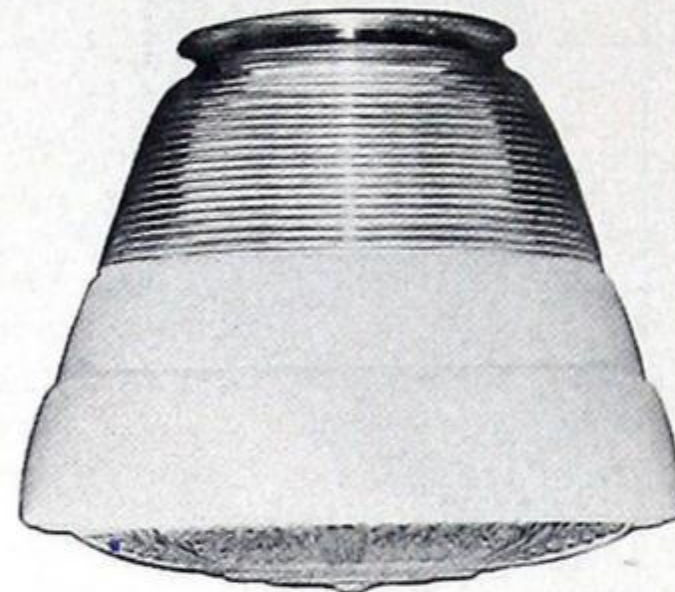

Nos. 1906-08



Nos. 1706-08

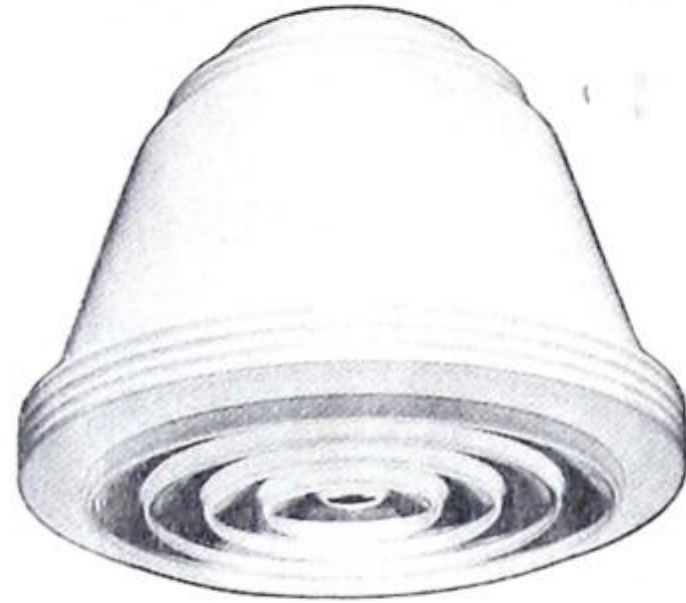

Nos. 9512-14

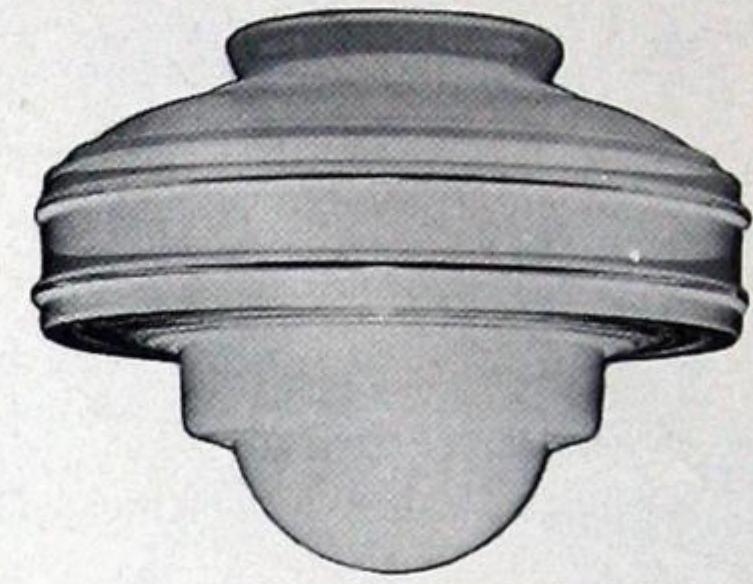

No. 709



Nos. 1508-12-14



Nos. 2106-08



No. 1974

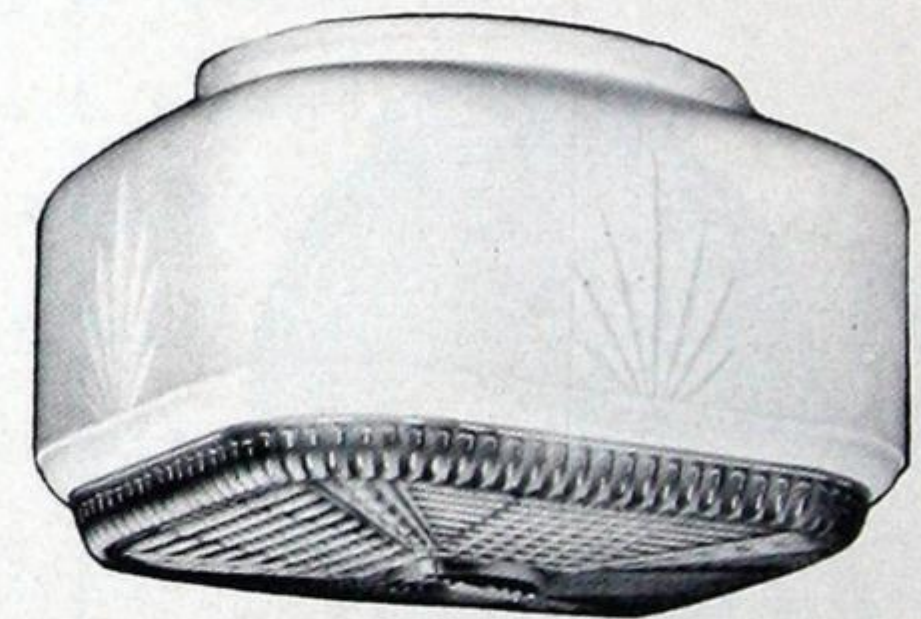

Nos. 2440-50



No. 2160

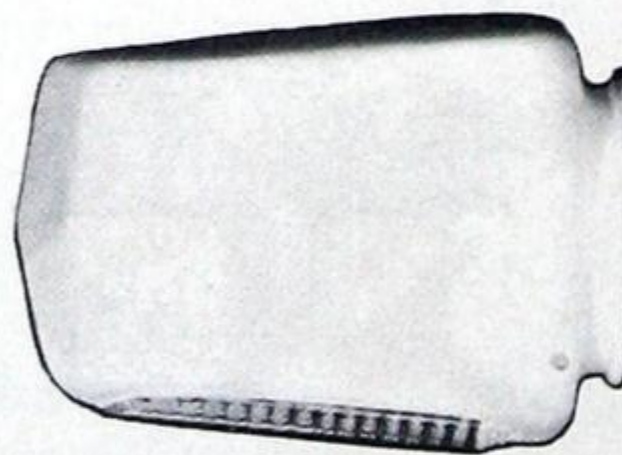

No. 473

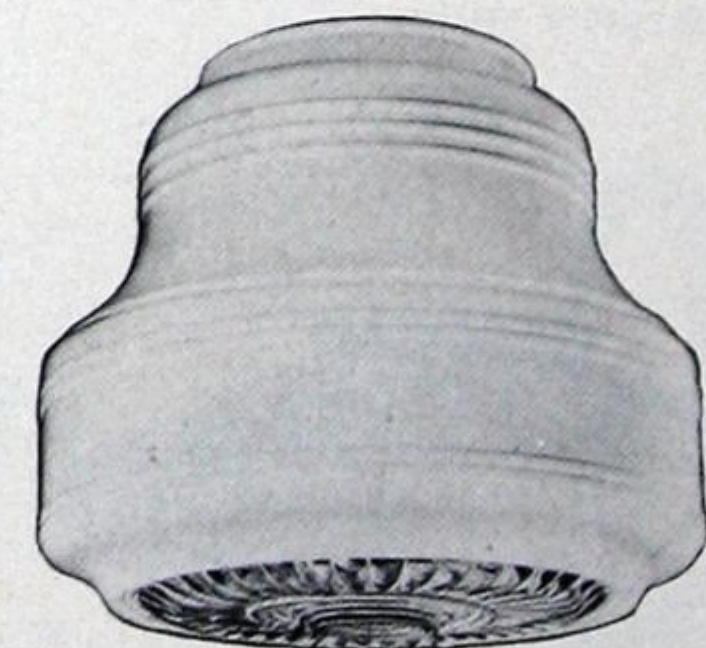

No. 2140

Catalogue No.	Diameter	Depth	Fitter	Std. Pkg.
473	6" Length	4 1/2"	3 1/4"	36
709	8 1/2"	6 1/2"	4"	12
1508	8 5/16"	6 3/8"	4"	12
1512	12"	8 5/16"	6"	4
1514	14"	9 1/2"	6"	2
1706	6 1/2"	6 7/16"	4"	12
1708	8 1/2"	7"	4"	12
1806	6 1/2"	6 7/16"	4"	12
1808	8 1/2"	7"	4"	12
1906	6 1/2"	6"	3 1/4"	12
1908	8"	7 1/4"	4"	12
1974	8"	6 1/4"	4"	12
2106	6"	5 3/8"	4"	27
2108	8"	7"	4"	12
2140	8"	7"	4"	12
2160	8"	7"	4"	12
2440	8" Square	5 1/4"	6"	12
2450	10" Square	5 1/4"	8"	6
9512	12"	9"	6"	4
9514	14"	10"	6"	2



LIGHTING GLASSWARE

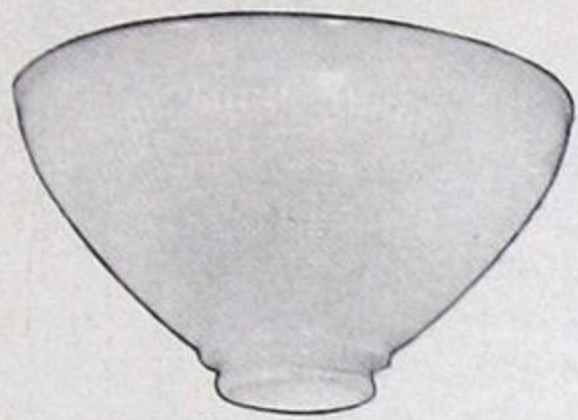

824160

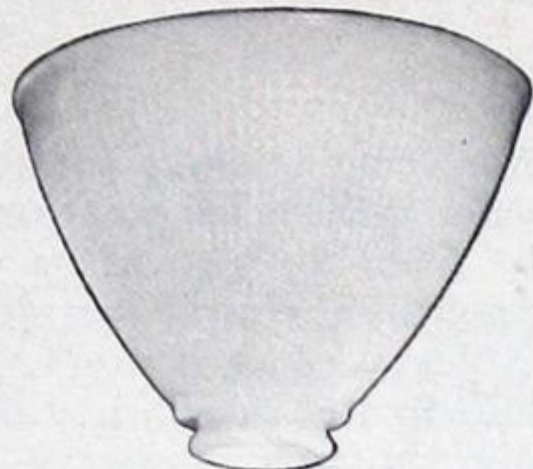

820120

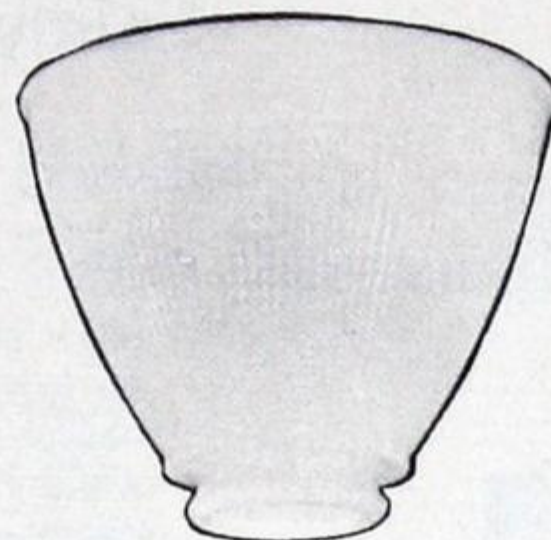

820090



160

Catalogue No.	Diameter	Depth	Fitter	Std. Pkg.
820090	6"	4 13/16"	2 1/4"	12
820120	8"	5 3/4"	2 1/4"	6
824160	10"	5 3/8"	2 7/8"	6
160	10"	5 3/8"	2 7/8"	6



Nos. 550, 551, 552



No. 536



Nos. 534, 535, 539

RUBY EXIT GLOBES

Catalogue No.*	Type	Letter Size	Width	Length	Fitter	Std. Pkg.
539	Pendent	3"	4 1/4"	5 1/4"	3 1/4"	18
552	Wall Mounting	3"	4 1/4"	5 1/4"	3 1/4"	18
534	Pendent	4"	5 1/2"	7"	3 1/4"	18
551	Wall Mounting	4"	5 1/2"	7"	3 1/4"	18
535	Pendent	5"	6 1/4"	7 3/4"	4"	12
550	Wall Mounting	5"	6 1/4"	7 3/4"	4"	12
536	Pendent	4"	6 1/2"	6 3/4"	3 1/4"	12

*Globes available in: Ruby Glass, White or Black Letters. Specify combination desired.



No. 520, 524



No. 523, 527



No. 522, 526

Catalogue No.*	Description	Lettered	Diameter	Fitter	Std. Pkg.
520	Wall Mounting	On end	6"	3 1/4"	12
524	Wall Mounting	On end	8"	4"	12
523	Pendent Mounting	Two sides	6"	3 1/4"	12
527	Pendent Mounting	Two sides	8"	4"	12
522	Wall Mounting	Two sides	6"	3 1/4"	12
526	Wall Mounting	Two sides	8"	4"	12

*Ruby Globes, White Letters.



SUSPENSION HANGERS AND CEILING BANDS

Safety Hangers

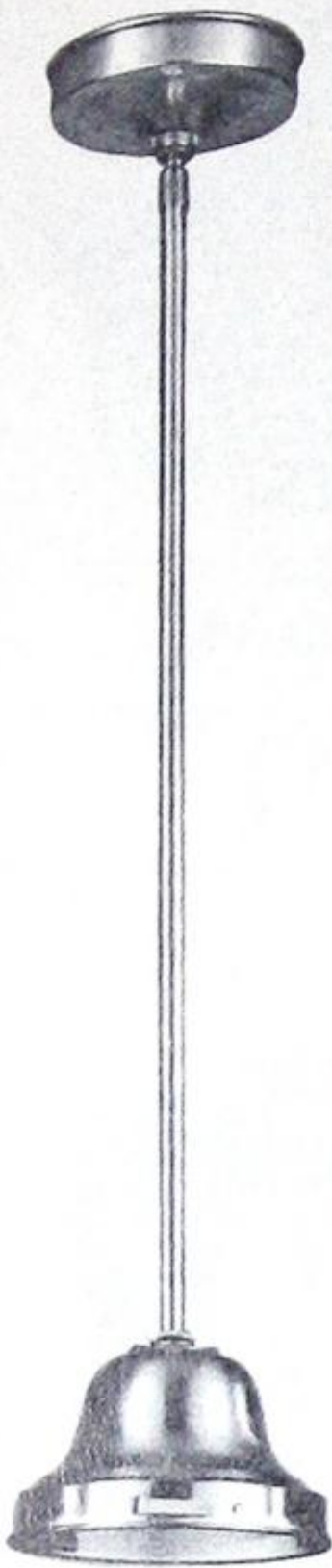

ROD HANGER



CLOSE HANGER

These are screwless type hangers that are permanently safe. The glassware is held in position by two shaped lugs permanently fixed to the fitter and a foolproof spring loaded lug enabling simple installation or removal of the glassware. No pressure is exerted upon the glassware itself eliminating the possibility of fracture of the neck of the globe through excessive strain, and the spring loaded retaining lug eliminates the possibility of the glassware becoming dislodged through vibration.

Cat. No.	Description	Socket	Overall Length	Fitter	Finish*
1174	Rod Hanger	Medium	29 1/2"	4"	Bronze, Brushed Chrome
1175	Chain Hanger	Medium	29"	4"	Bronze, Brushed Chrome
1176	Rod Hanger	Medium	30 1/2"	6"	Bronze, Brushed Chrome
1176M	Rod Hanger	Mogul	30 1/2"	6"	Bronze, Brushed Chrome
1177	Chain Hanger	Medium	30"	6"	Bronze, Brushed Chrome
1177M	Chain Hanger	Mogul	30"	6"	Bronze, Brushed Chrome
1620	Close Hanger	Medium	5"	4"	Bronze, Brushed Chrome, White Enamel
1621	Close Hanger	Medium	5 3/8"	6"	Bronze, Brushed Chrome, White Enamel
1622M	Close Hanger	Mogul	5 3/8"	6"	Bronze, Brushed Chrome, White Enamel

*Specify finish desired.

Rod and Chain Hangers can be supplied in other than standard lengths if specified.

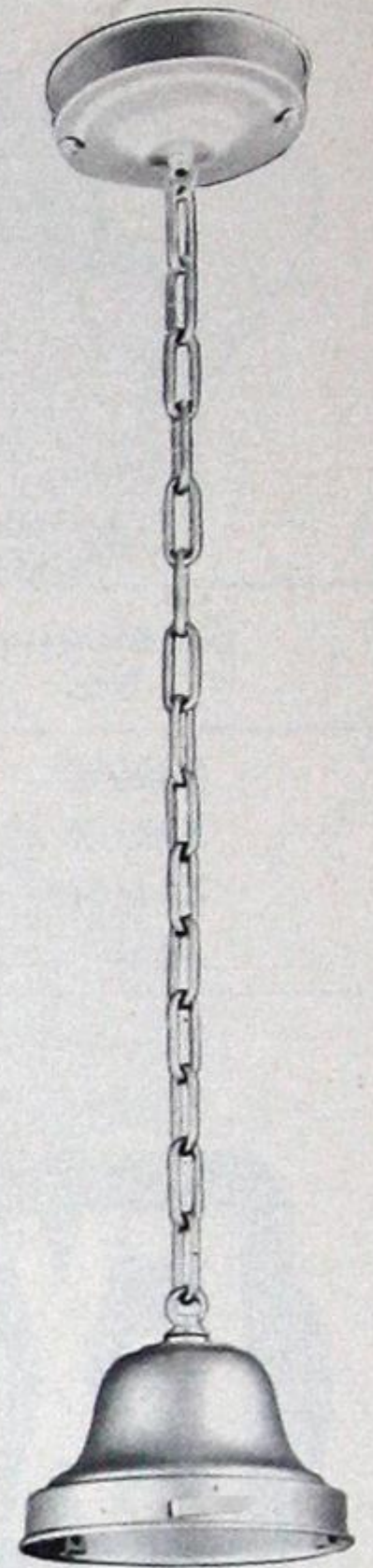

CHAIN HANGER

Standard Hangers

Economical screw-type hangers and ceiling bands, for all standard lighting applications.



CLOSE HANGER



CEILING BAND

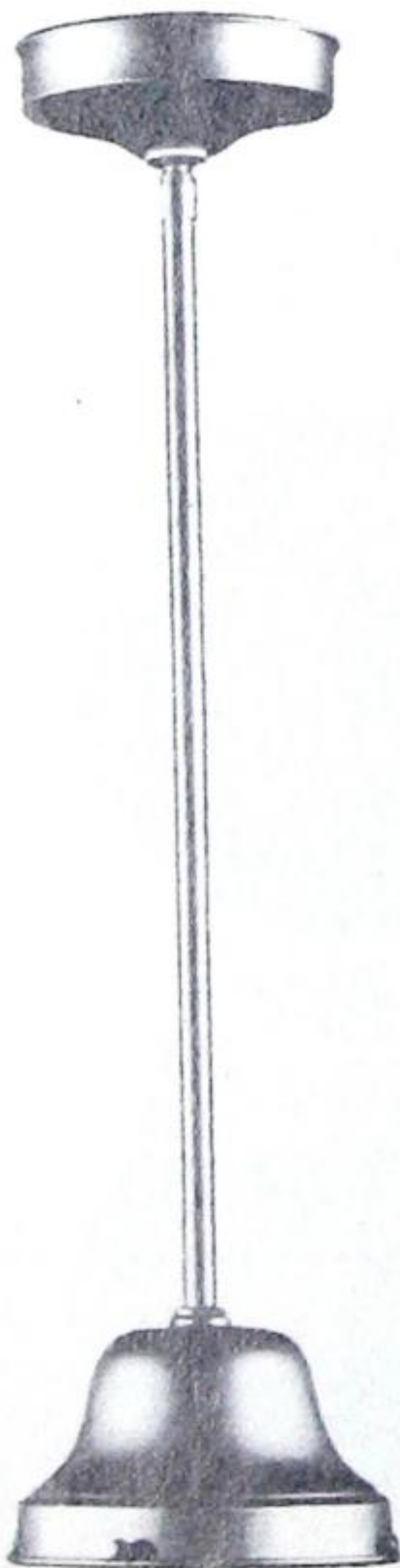

ROD HANGER

Cat. No.	Description	Socket	Overall Length	Fitter	Finish*
1178	Rod Hanger	Medium	29 1/2"	4"	Bronze, Brushed Chrome
1180	Rod Hanger	Medium	30 1/2"	6"	Bronze, Brushed Chrome
1180M	Rod Hanger	Mogul	30 1/2"	6"	Bronze, Brushed Chrome
1184	Chain Hanger	Medium	29"	4"	Bronze, Brushed Chrome
1186	Chain Hanger	Medium	30"	6"	Bronze, Brushed Chrome
1186M	Chain Hanger	Mogul	30"	6"	Bronze, Brushed Chrome
1627	Close Hanger	Medium	5"	4"	Bronze, Brushed Chrome, White Enamel
1628	Close Hanger	Medium	5 3/8"	6"	Bronze, Brushed Chrome, White Enamel
1629M	Close Hanger	Mogul	5 3/8"	6"	Bronze, Brushed Chrome, White Enamel
1713	Ceiling Band	Medium	1 3/4"	3 1/4"	Bronze, Brushed Chrome, White Enamel
1714	Ceiling Band	Medium	1 3/4"	4"	Bronze, Brushed Chrome, White Enamel
1715	Ceiling Band (Pull Chain)	Medium	1 3/4"	4"	Bronze, Brushed Chrome, White Enamel
1724	Ceiling Band	Medium	1 3/4"	6"	Bronze, Brushed Chrome, White Enamel
1724M	Ceiling Band	Mogul	2 3/4"	6"	Bronze, Brushed Chrome, White Enamel

*Specify finish desired.

Rod and Chain Hangers can be supplied in other than standard lengths if specified.

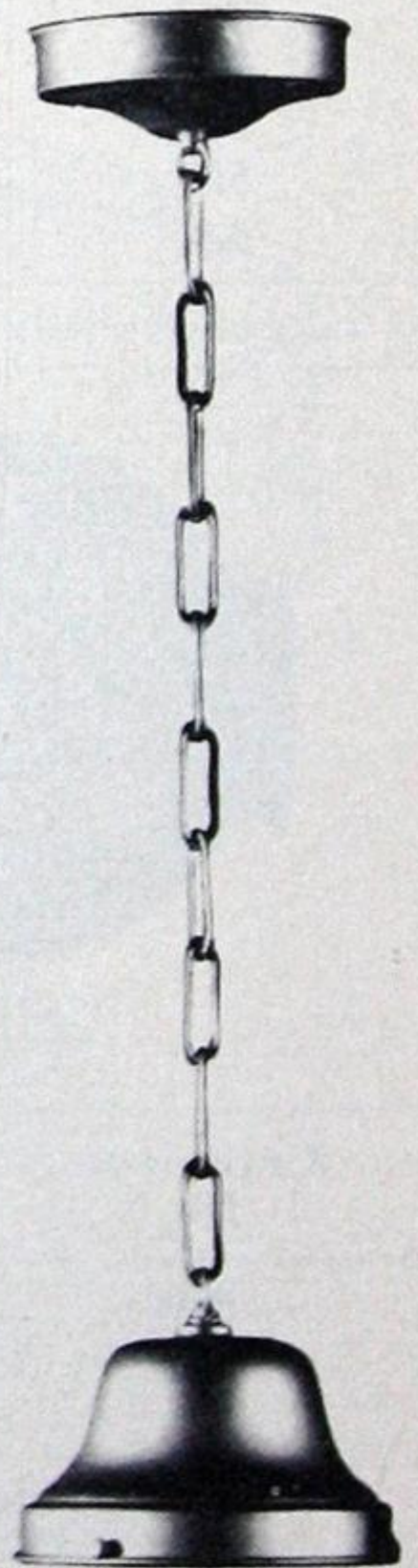

CHAIN HANGER



LIGHTING GLASSWARE

Safety Holder
For any 4" or 6" Fitter Glassware

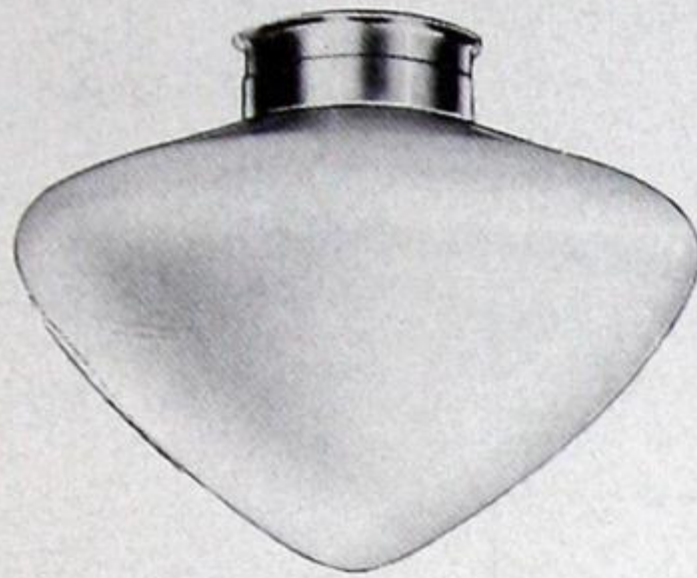

1049 SERIES

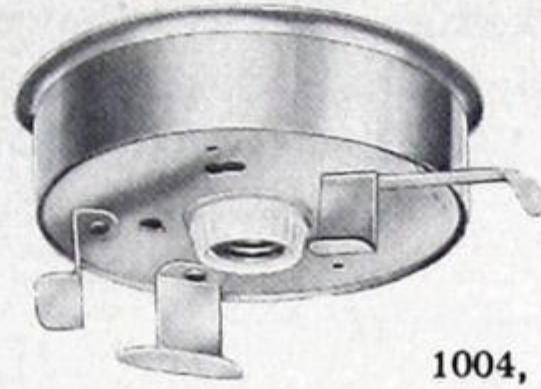

1004, 6

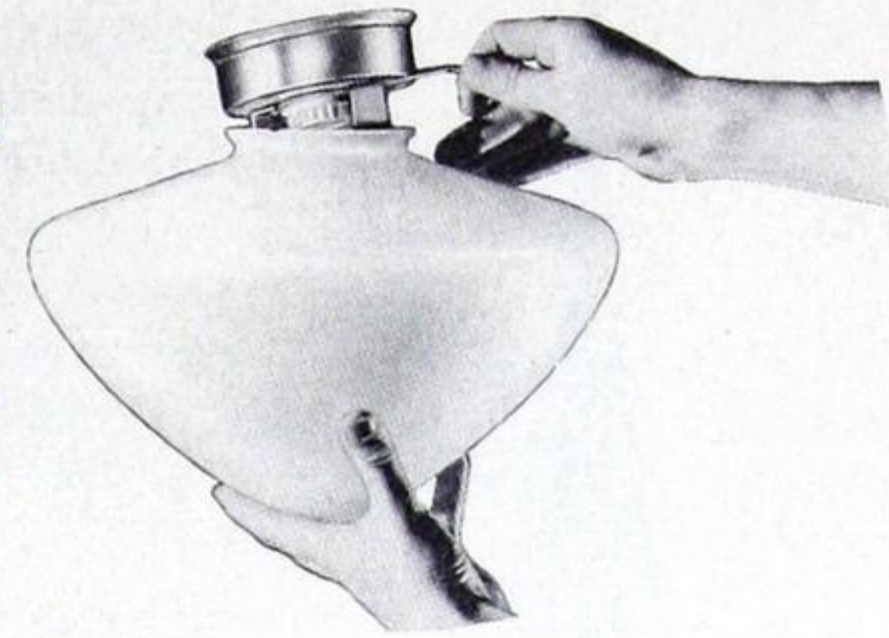

"1049 Series"

The 1049 Series of ceiling lights are equipped with the new Lever-Lock safety holders, No. 1004-4" and No. 1006-6". The Continental shape Silvaglo glass is supported from within the neck of the globe, with no possibility of falling or breaking. The Lever-Lock principle does away with all screws, springs and other methods of holding glassware and provides a safe, simple and fast method of attaching and detaching the globe.

Cat. No.	Description	Fitter Size	Max. Lamp Watts.	Glass Diameter	Replacement Glassware
1004	Lever-Lock Holder Only	4"	—	—	—
1006	Lever-Lock Holder Only	6"	—	—	—
1049-9	Holder and Glassware	4"	100	9 ³ / ₈ "	Quote unit Catalogue No. and specify. "Glassware only"
1049-12	Holder and Glassware	4"	150	12 ³ / ₈ "	
1049-14	Holder and Glassware	6"	200	14 ³ / ₈ "	
1049-16	Holder and Glassware	6"	300	16 ³ / ₈ "	
1049-18	Holder and Glassware	6"	300	18"	

"1312 Series"

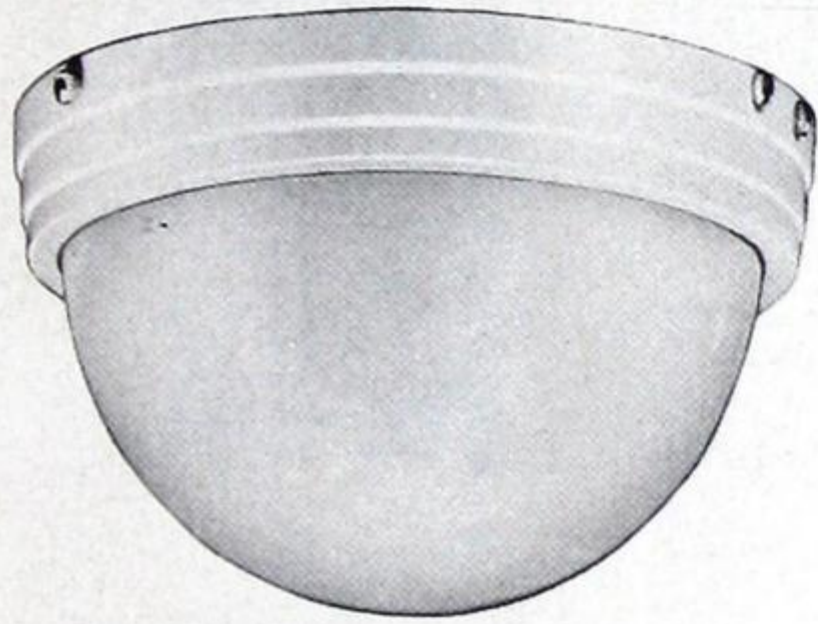

1312 SERIES

These new Hinge-Action units with Silvaglo hemispherical glass, are simple and easy to install and operate. The dust-free bands drop down for cleaning or relamping and may be removed completely if desired. Replacement Glassware—Quote unit Catalogue No. and specify "Glassware only".

Cat. No.	Max. Lamp Watts	Overall Width
1312-6	40	6 ¹ / ₂ "
1312-8	60	8 ¹ / ₂ "
1312-10	100	10 ¹ / ₂ "
1312-12	150	12 ¹ / ₂ "



"No. 1170 Square Fixture"

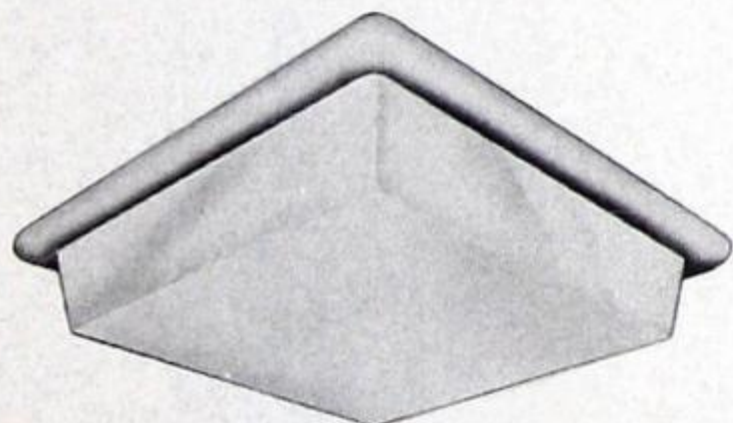

1170

This unit with Silvaglo glass is simple and ruggedly constructed. The cast aluminum frame which carries the glass is attached to the ceiling plate at four points and may be completely detached, or dropped in a hinged manner from either side for cleaning or relamping. The glass is held firmly in place in the ring and cannot fall out when detached or hinged down for service. Replacement Glassware—Quote unit Cat. No. and specify. "Glassware only".

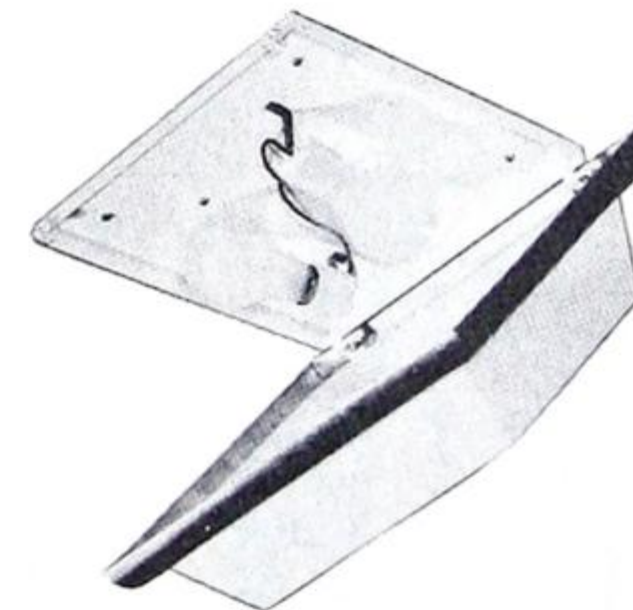

"6851 Series"

This series of pendent ball fixtures with Silvaglo glass incorporate a special inconspicuous metal holder of the safety type. The glass is supported from inside the globe, on the bottom part of the holder while the top part or cover is held firmly in place with a locknut to prevent movement of the glass. The glass is thus held between the two parts of the holder and may be easily removed for cleaning and relamping.

Catalogue No.	Max. Lamp Watts	Overall Length	Ball Diameter	Replacement Glassware
6851-10	150	30"	10"	Quote unit Cat. No. and specify "Glassware only"
6851-12	200	30"	12"	
6851-14	300	30"	14"	
6851-16	500	30"	16"	

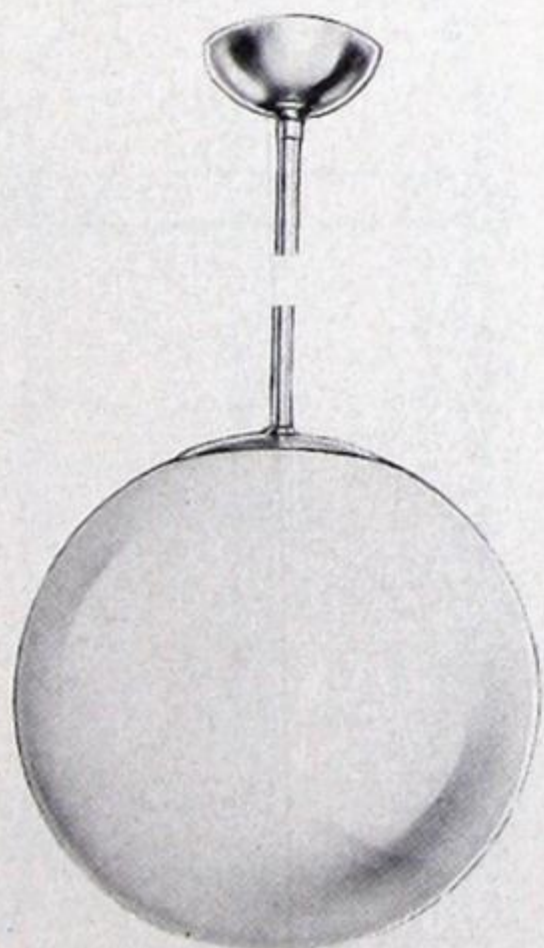

6851 SERIES

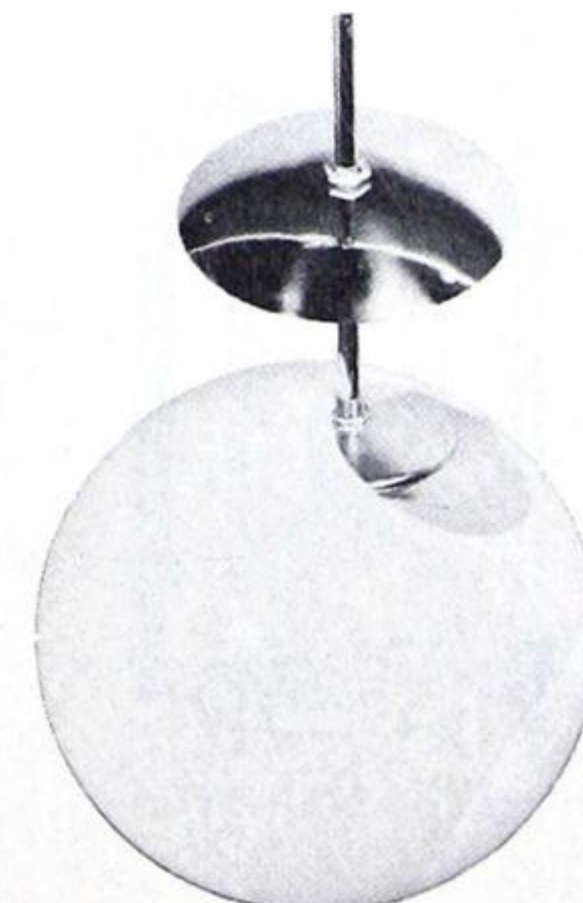

CHURCH LIGHTING UNITS

Wilson Church Lighting Units

A complete selection of lighting units is available for the harmonious lighting of churches and religious institutions of all architectural styles. Shown here are the Gothic Lantern Series, and the Cylindrical Lantern Series. Also available are the Cathedral, Stalactite, and Gothic Glass Series all designed to enhance the quiet dignity of religious interiors. For complete information—CONSULT YOUR LOCAL NORTHERN ELECTRIC OFFICE.

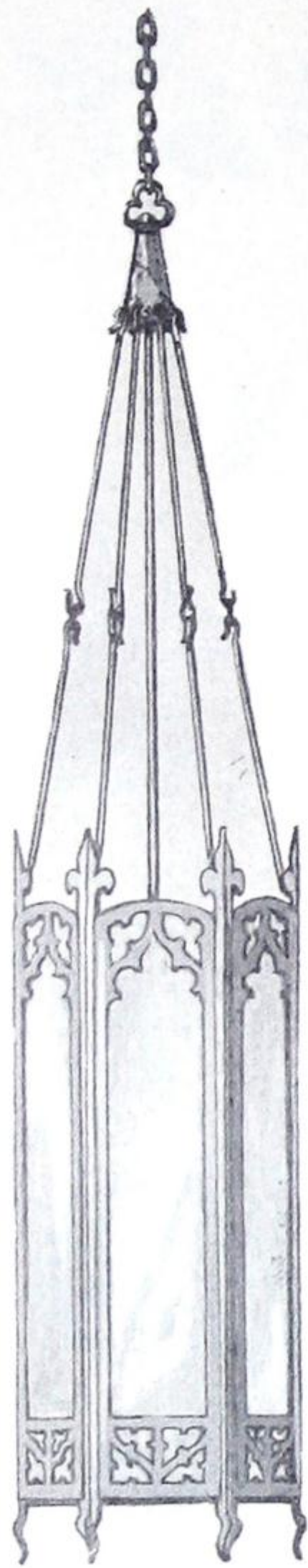

Nos. 2516-2517

Cat. No.	Style	Lamp Watts	Overall Dimensions		Overall Suspension
			Length	Width	

Gothic Lantern Series

2516	Suspension Unit	1-300* 3-60*	71"	16"	144"
2517	Suspension Unit	1-500* 3-60*	84"	18"	144"
2518	Suspension Unit	100-150	26"	7"	48"
2519	Weatherproof Wall Unit	100-150	30"	11"	—
2520	Ceiling Unit	100	6"	14"	—
2521	Ceiling Unit	2-60	8"	18"	—

Cylindrical Lantern Series

2506	Suspension Unit	1-500* 3-60*	37"	14"	60"
2507	Suspension Unit	1-300* 3-60*	34"	12"	60"
2508	Suspension Unit	150-300	26"	10"	60"
2509	Ceiling Unit	100	13"	11"	—
2510	Wall Unit	100	14"	9"	—
5557	Weatherproof Wall Unit	100	19"	11"	—

*Two separate circuits.
Note: Length and Width dimensions include everything but chain suspension.

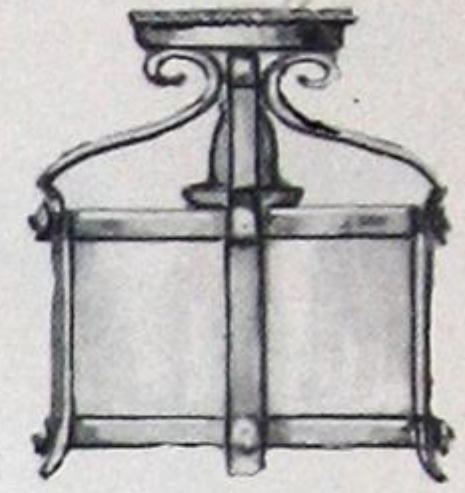

No. 2509

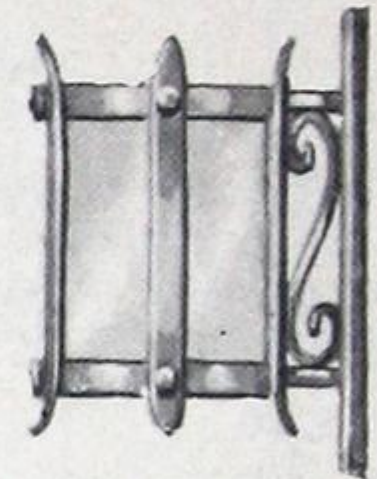

No. 2510

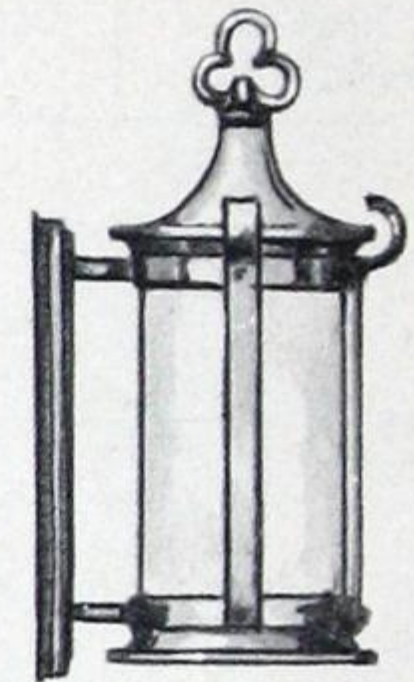

No. 5557



Nos. 2520-2521

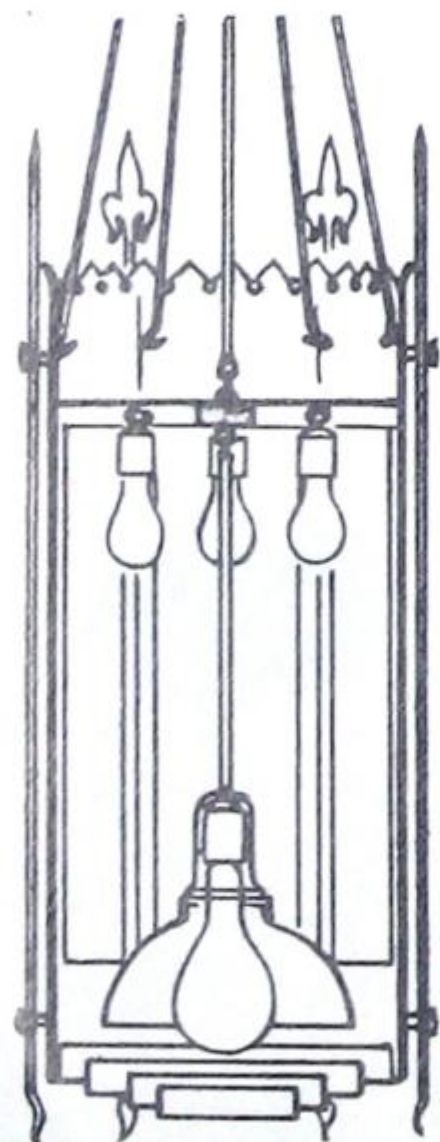

SECTIONAL VIEW
Nos. 2516, 17



No. 2518



No. 2519—WEATHERPROOF

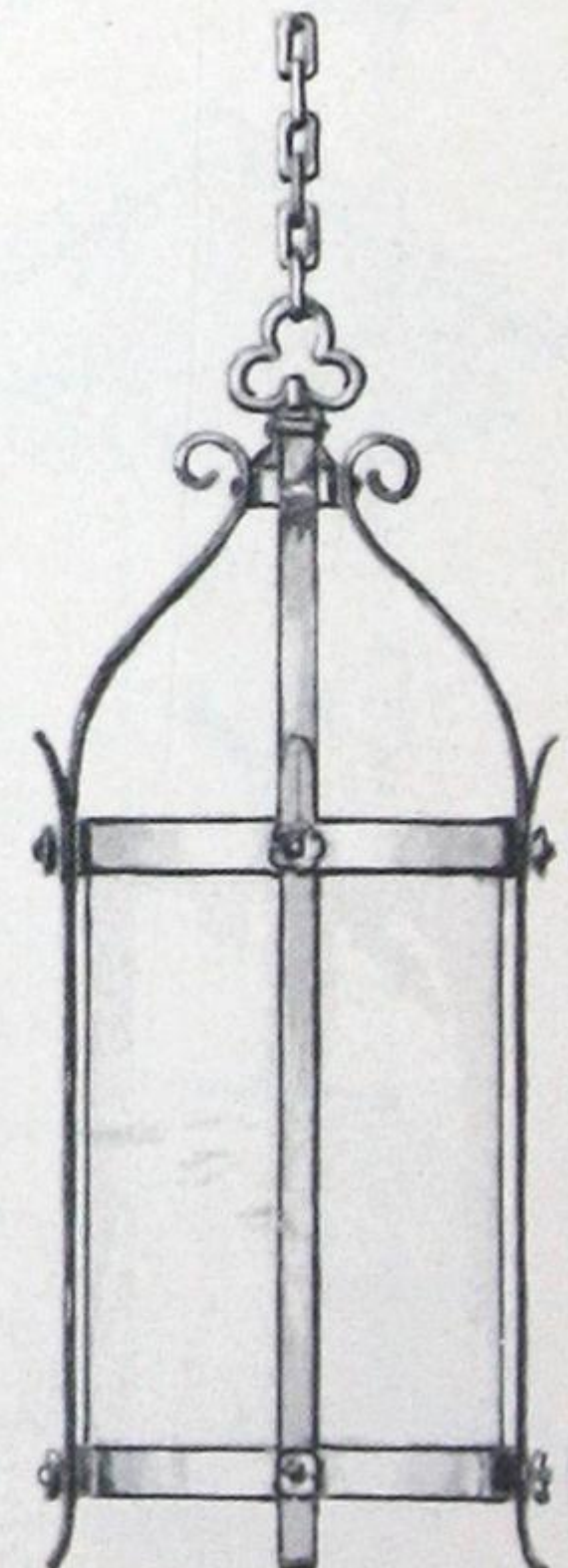

Nos. 2506, 2507, 2508



SHOW-WINDOW REFLECTORS



DISTRIBUTING TYPE

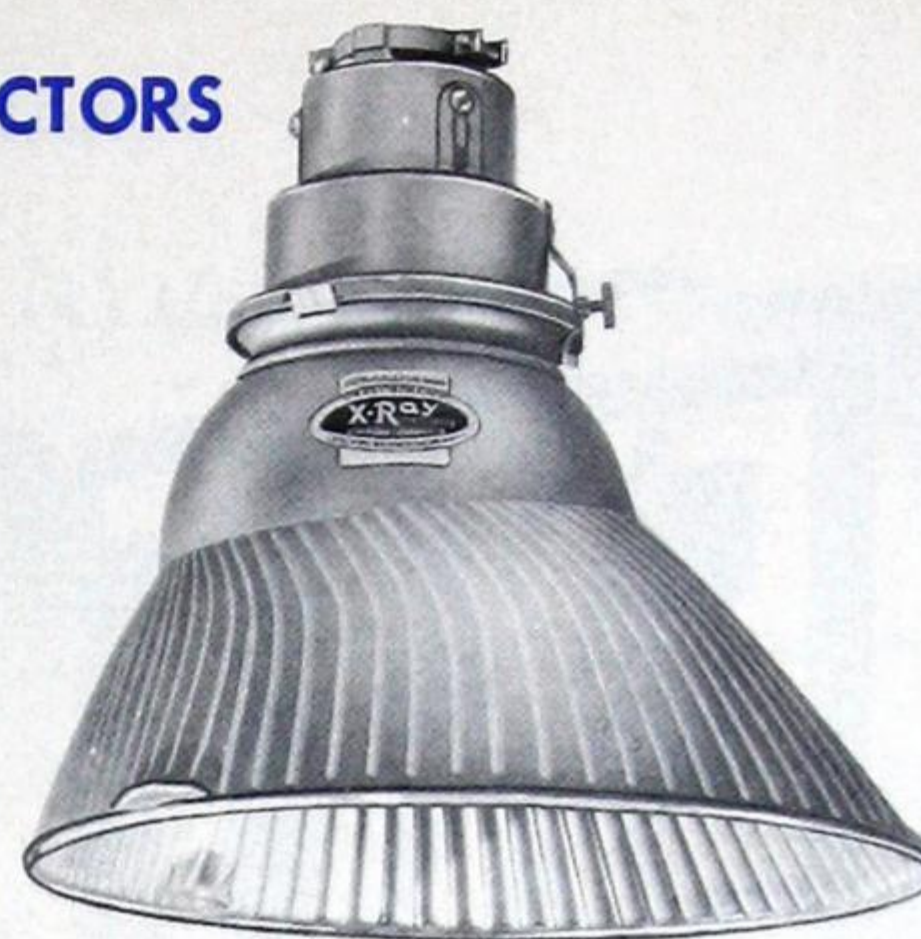

CONCENTRATING TYPE

Curtis Silvered Glass Show-Window Reflectors

The Curtis X-Ray Show-Window Reflectors are made from crystal clear high-grade glass, the outer surface of which is coated with pure silver, thus achieving the highest possible reflection qualities. The silver coating is protected by a permanent finish which keeps the reflector always as good as new.

The distributing type reflectors are designed for use in deep windows (those in which the depth of window is approximately equal to the height). Where the trim line extends high at the back, they are ideal.

The concentrating or "Attraction-Zone" reflectors concentrate 35% to 50% more light in the lower portion of the window.

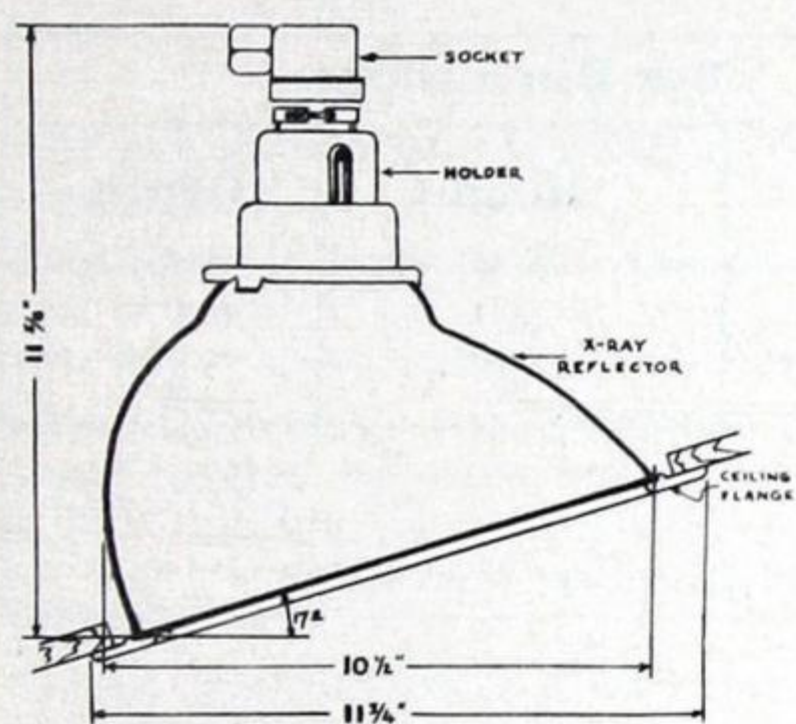

No. 500-C UNIT

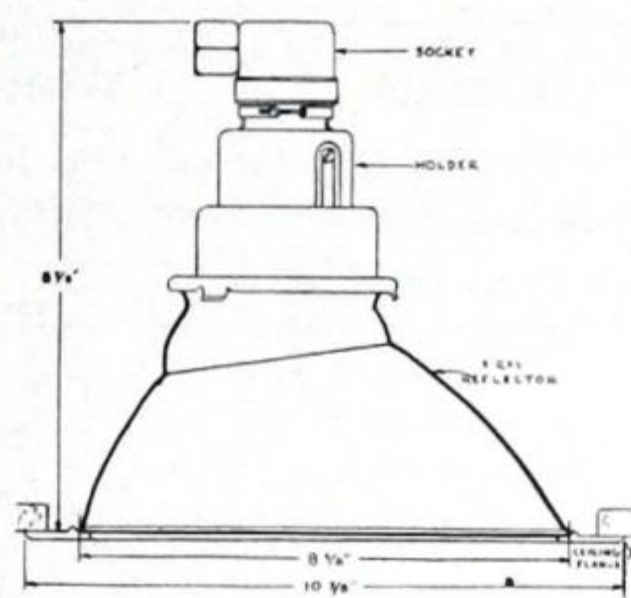

No. 420-C UNIT

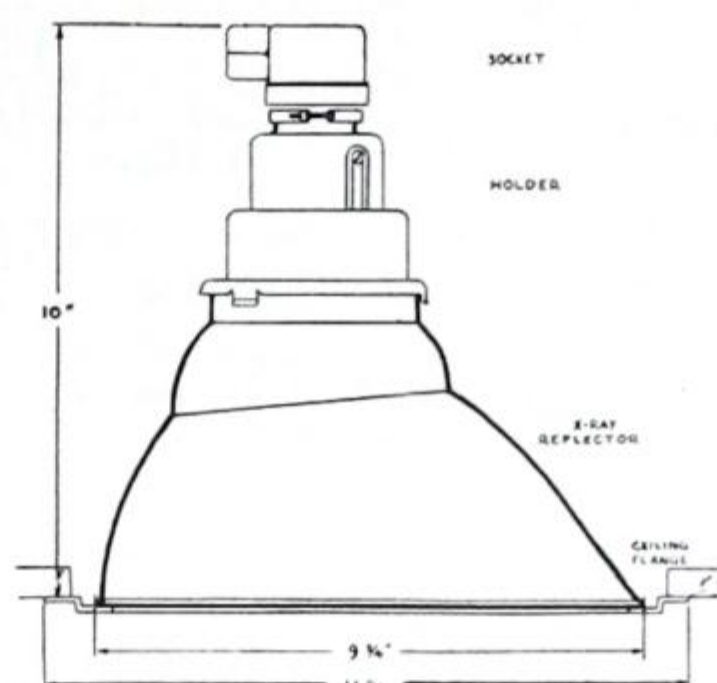

No. 530-C UNIT

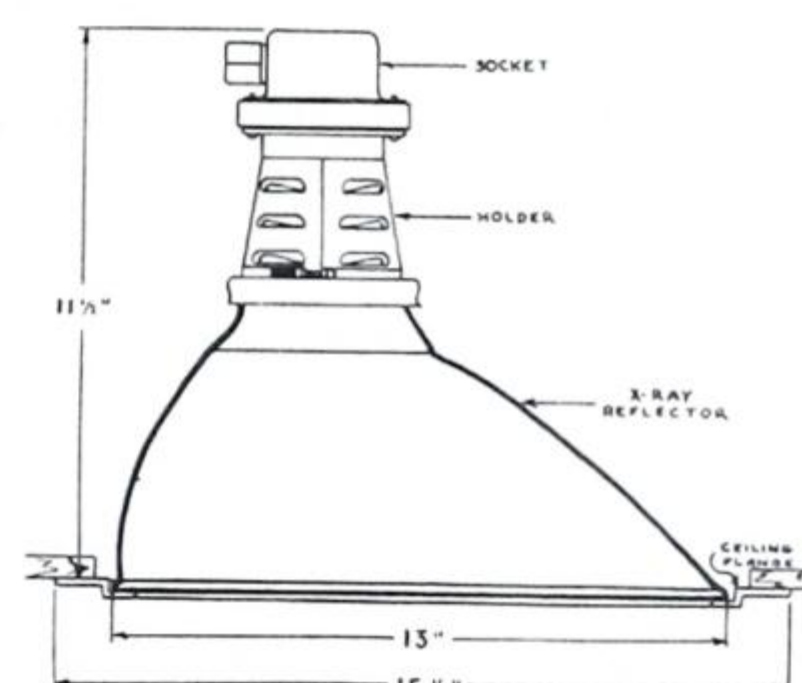



No. 1010-C UNIT

Complete Recessed Units

Complete Unit	Lamp Watts	Distribution	Components			Accessories		
			Reflector	Socket	Holder	Louver	Plaster Ring	Finishing Flange
500-C	150/300	Distributing	500-R	8291-S	10668	—	—	11500
420-C	100/150	Concentrating	420-R	8291-S	10668	12420	14027	10517
530-C	150/300	Concentrating	530-R	8291-S	10668	12531	14028	14026
1010-C	300/500	Concentrating	1010-R	8301-S	10010	12110	14111	14110

Equipment for Special Mounting Arrangements

Cat. No.	Catalogue No. Includes	Shadeholder Groove Sockets*				Louver* (Attaches to Reflector)
						
		For Mounting On				
		1/2" Pipe	Curtistrip	3" Box	4" Box	
500	500R Distributing reflector for 150-200W lamps and 10668 Adjustable Holder only, for any shade-holder groove socket.	8290B	5	10160B	10161B	—
420	420R Concentrating reflector for 100-150W lamps, and 10668 adjustable holder only, for any shade-holder groove socket.	8290B	5	10160B	10161B	12420
530	530R Concentrating reflector for 150-300W lamps and 10668 adjustable holder only, for any shade-holder groove socket.	8290B	5	10160B	10161B	12531
1010	1010R Concentrating reflector for 300-500W lamps, 10668 adjustable holder and 8300B socket.	—	—	—	—	12110

*Specify separately.



AMALGAMATED EXIT LIGHTS



No. 3480



No. 3481

The two Exit Light units shown above are for flush and surface mounting respectively. The 6" high red lettering on black background makes the letters distinct and legible. The units are equipped with one medium base porcelain receptacle, and the flush plate on No. 3480 is brushed nickel.

Glassware for these units is available with special lettering if specified.

Catalogue No.	Description	Finish		Box Dimensions		
		Inside	Outside	Width	Height	Depth
3480*	Flush Mounting	Sprayed Al.	Sprayed Bronze	12"	8"	4"
3481*	Surface Mounting	Sprayed Al.	Sprayed Bronze	12"	8"	4"

*Specify EXIT or SORTIE lettering on glass.
Replacement glass No. 3481-7A, Specify lettering.
Units can be supplied with wire guard if specified.

AMALGAMATED POT LAMPS

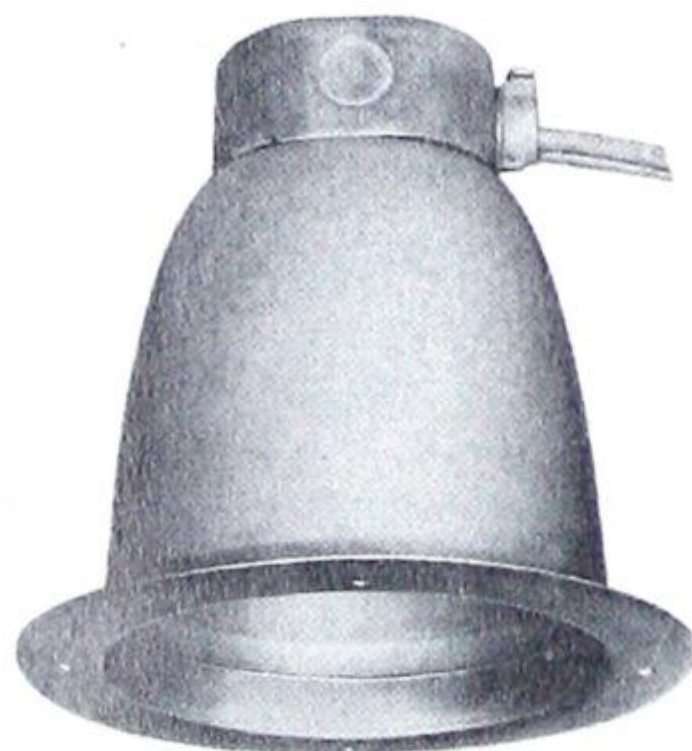

Nos. 885, 886

These flush mounting Pot Lamps have been developed for theatres, show windows, hallways and other similar applications. They are designed for 150-watt R40 reflector floodlamps, but will accommodate standard low wattage lamps where low level illumination is desired.

The units are spun from code gauge steel, finished aluminum, and include a medium base socket, plaster ring, outlet box, connector and four feet of asbestos covered wire.

Two types are available: (a) two-piece construction for relamping from above, (b) one-piece construction for relamping from below.

Catalogue No.	Description	Dimensions		
		Height	Diameter of Ceiling Opening	Diameter of Ceiling Ring
885	For relamping from above	7 1/4"	7 1/4"	7 3/4"
886	For relamping from below	7 1/4"	7 1/4"	7 3/4"

AMALGAMATED GYMNASIUM UNIT

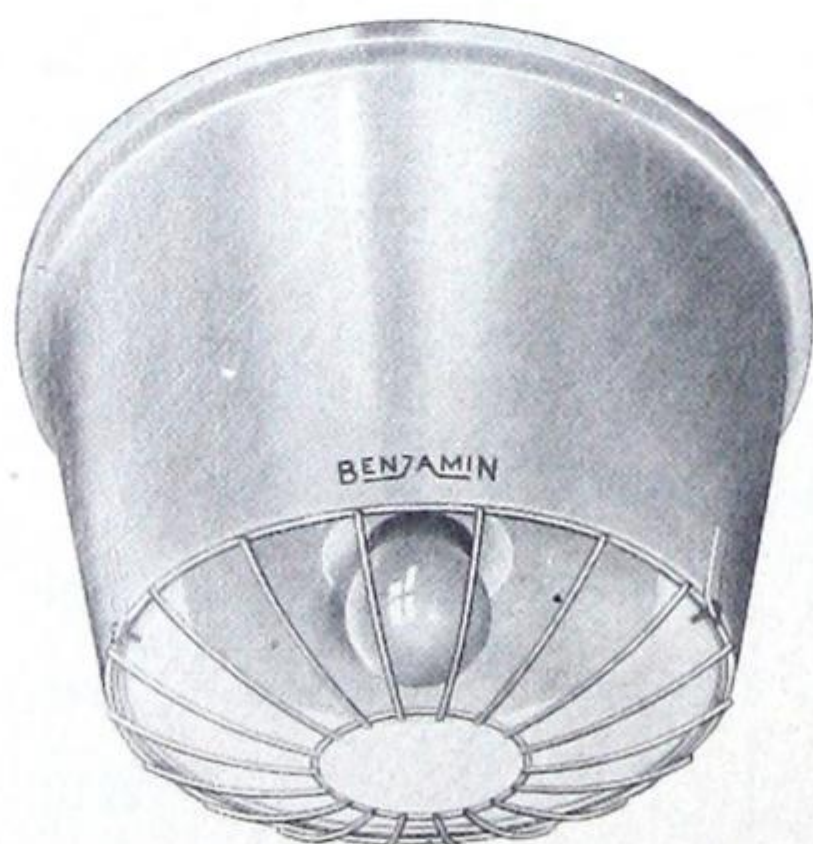

No. 6301

This Gymnasium unit is a specially designed, completely guarded RLM dome fixture of good appearance, particularly suitable for Gymnasiums, Indoor Baseball Courts, Volleyball Courts, Indoor Sport Arenas and similar locations. It is so sturdily constructed that it will stand up indefinitely under rough treatment that would be fatal to ordinary lighting equipment.

It is not necessary to remove guard for lamp replacement as a large hole in the bottom of the guard permits passage of lamp.

The loosening of three thumb screws allows complete removal of guard and gives free access to reflector for cleaning. Unit is finished in white paint enamel, and reflector is white porcelain enamelled steel.

Catalogue No.	Lamp Watts	Description	Overall Dimensions		Reflector Diameter
			Diameter	Depth	
6301	300/500	With Mogul Base Receptacle.	24"	13 1/2"	18"



OUTDOOR UNITS



No. 420

The prismatic construction sends more light over a larger area. A unit mounted ten feet above the ground and using a 200 watt lamp will illuminate a semi-circle of 35 feet radius with an average illumination of 0.5 foot-candle. The light which would normally fall on the wall is directed into useful zones.

Holophane No. 420 A-Way (R) Unit

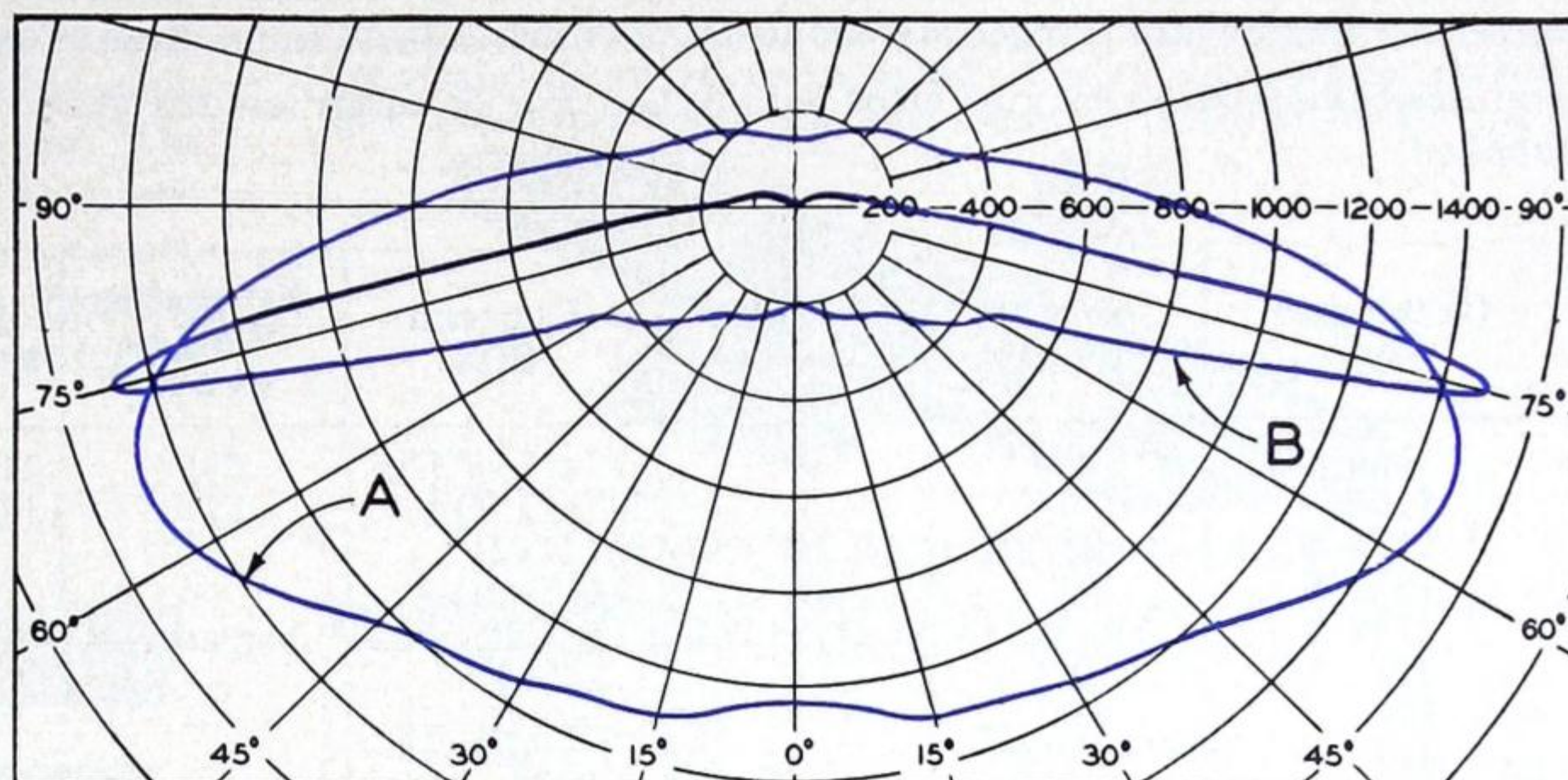

CANDLEPOWER DISTRIBUTION No. 420, 200 WATT CLEAR, 3700 LUMENS.
 "A"—LATERAL DISTRIBUTION IN 75° CONE.
 "B"—VERTICAL DISTRIBUTION THROUGH 65° LATERAL.

The new Holophane No. 420 A-WAY luminaire is a wall mounted fixture with a wide spread assymetric distribution using a 200 Watt lamp.

This durably constructed outside unit can be utilized on either industrial or residential locations. Warehouses, gates, fences, platforms and protective lighting as well as entrances, housing developments and garage doors are some of the outstanding examples of use for this heavy duty weather-proof unit.

The 420 A-WAY unit produces not less than 1450 candlepower at 15° below horizontal in a vertical plane taken through the lateral cones located 65° each side of zero. The curve of lateral distribution in the 75° cone shows 140 candlepower maximum at 180°, which is the building (or house) side; and at 0°, which is on the opposite (or street) side, the candlepower is not less than 1015. Therefore, the light which would normally fall on the wall is directed into useful zones providing the highest level of illumination where it is most needed:

The fixture consists of a waterproof cast metal housing, a two-piece sealed refractor held together by a split ring flange. Flange is supported to hood by a hinge pivot bar and two captive thumb screws. In the open position the refractor swings free to allow easy removal and maintenance.

The compound refractor is made of pressed crystal glass with smooth surfaces inside and outside—the prismatic construction being sealed in a dust-proof inner chamber.

The unit is supplied with a triangular mounting strap, a 3/8" pipe nipple, locknuts and hickey. The gasketed base covers a 3 1/4" or 4" outlet box.

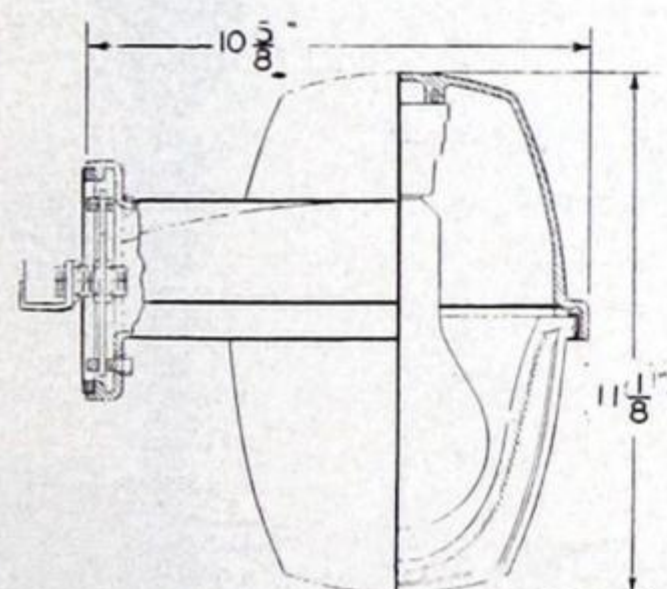

Cat. No.	Lamp Watts	Termination	Dimensions	
			Depth	Projection from Wall
420	200	Mounts on 3 1/4"-4" Outlet Box	11 1/8"	10 5/8"

(R) The Holophane Co. Ltd.

Holophane Postop Unit



No. 04340

The Holophane Postop outdoor unit is designed to fill a long standing requirement for an outdoor lighting unit to take the place of the unattractive "goose neck" mounted fixtures. The prismatic light controlling surface is substantially smooth on the outside so that no dirt lodges on its surface, and the unit slips over a 1" pipe standard and is locked in position by a set screw. Relamping is easily accomplished by snapping off the captive gasketed aluminum cover.

The light distribution is of the A-Way Asymmetric type with angle of maximum candlepower at 60° above the vertical.

Catalogue No.	Lamps Watts	Termination	Dimensions	
			Depth	Diameter
04340	100*-150	Slip-fitter for 1" pipe	11 1/4"	8 3/4"

*Use 1 3/8" Socket extension.



OUTDOOR UNITS

Kondu Ornamental Standards, Wall Brackets and Balustrade Units

The exterior lighting fixtures shown below are but a few of the many decorative units available for the lighting of buildings, parks, drive-ways, etc. Black finish is standard but Green, Swedish Iron, Antique Bronze, or Copper will be supplied if specified. Fixtures having panels may be fitted with either clear or amber sanded glass. Unless otherwise specified; clear sanded panels will be supplied.

Catalogue No.	Overall Height	Height of Standard	Lantern Size	Extension, Wall to Centre	Base or Wall Plate	Approx. Weight
1660	25"	—	17"x17½" Dia.	6⅝"	24"x7¼"	16 lbs.
1661	36"	—	30"x12" Dia.	12"	36"x11"	23 lbs.
1171-S	102"	71"	14"x21"	—	19"	185 lbs.
1374-S	60"	45"	7½"x10½"	—	9" Sq.	50 lbs.
1101-S	Similar to No. 1171-S but for Ball Globe* instead of Lantern.					156 lbs.
271	36"	—	14"x21"	—	12"	55 lbs.
274	20"	—	7½" 10½"	—	6"	12 lbs.
402	17½"	—	Ball*	—	10½" Sq.	30 lbs.
2402	11"	—	Ball*	9¼"	7¼"x15½"	10 lbs.
2171	58½"	—	14"x21"	12"	7¾"x16½"	95 lbs.
2172	50"	—	12"x15½"	12"	7¾"x16½"	60 lbs.

*No. 1101-S takes globe with 6" fitter, not included.
 No. 402 takes globe with 4" fitter, not included.
 No. 2402 supplied with 3¼", 4", 5" or 6" fitter, specify size required, globe not included.

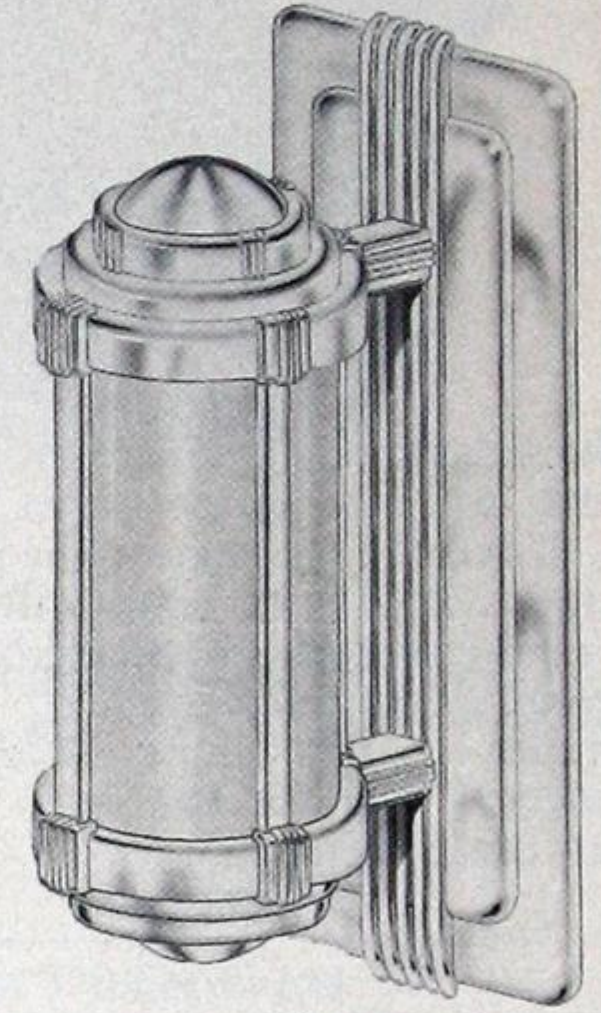

No. 1660, 1661

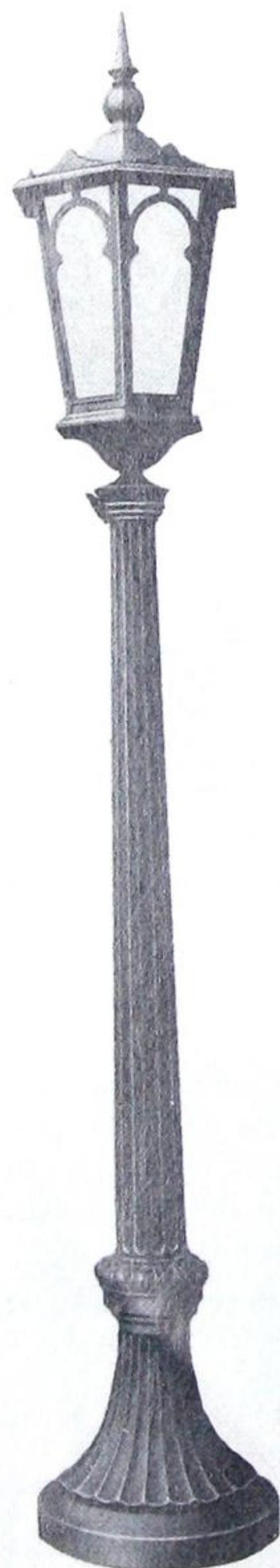

No. 1171-S

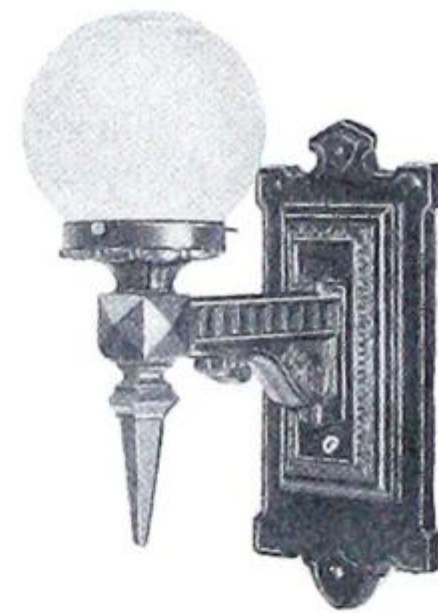

No. 2402



No. 2172



No. 2171

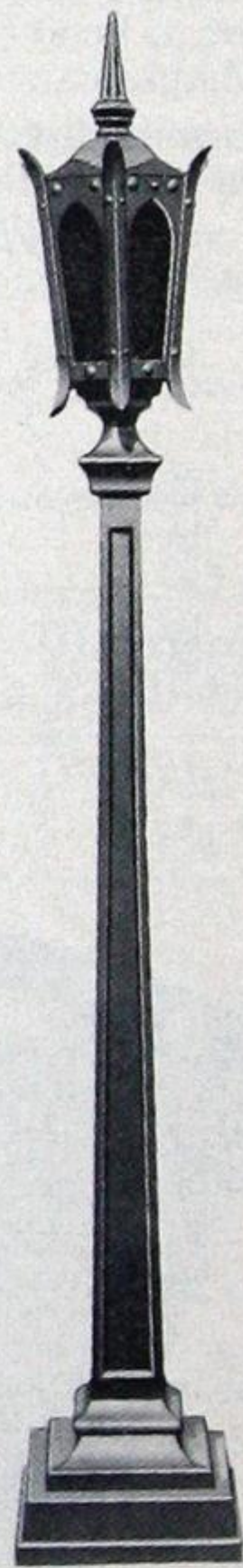

No. 1374-S



No. 271



No. 274



No. 402



STRIP LIGHTING

Curtis Incandescent CurtiStrip

CurtiStrip is a large capacity (30 No. 14 R.C. wires) wiring channel and raceway that offers unusual flexibility and a wide range of uses with its standardized fittings. The patented snap-in flat cover permits outlets to be installed on any spacing. The cover, placed between sockets or fittings, is cut to length required with tinner's shears and snaps into the lips of the channel. Channel may be cut to any length with a hacksaw. Sections longer than 10 feet may be coupled together to form a continuous channel.







CURTISTRIP CHANNEL AND COVER

Channel and cover made of 20-gauge cold rolled steel, Cadmium plated. Size, 2 1/2" wide x 1 5/8" deep.

Cat. No.	Description	Std. Pkg.
1	Channel with cover, 10 ft. lengths.....	100 ft.
1-A	Channel only, 10 ft. lengths.....	100 ft.
1-B	Cover only, 10 ft. lengths.....	100 ft.

CURTISTRIP FITTINGS

Standard Finish: Cadmium Plate

Fitting	Cat. No.	Description	Std. Pkg.
 No. 6	6	End cap for closing ends of CurtiStrip. Has 1/2" knock-out.....	10
 No. 12	12	Service box for connecting 3/4" to 1 1/2" conduit to CurtiStrip.	1
 No. 14	14	Adjustable elbow for angles of 70° to 180°.....	1
 No. 16	16	Coupling for connecting two pieces of CurtiStrip.....	10
 No. 18	18	Box Adapter fits CurtiStrip to standard 4" outlet box.....	10



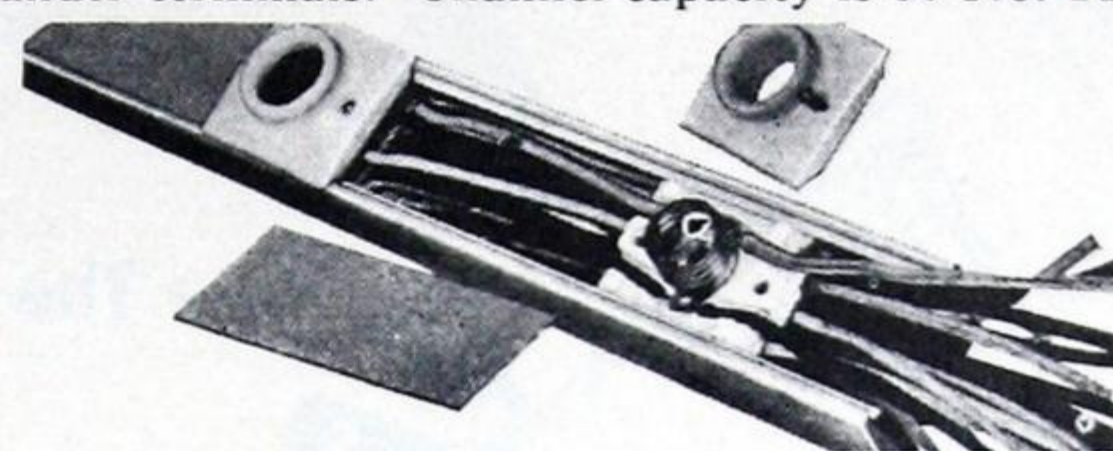

CURTISTRIP ASSEMBLED

Illustration shows assembled section of CurtiStrip with one socket cover and cover spacer removed. Notice wires are stripped and laid under terminals. Channel capacity is 30 No. 14 R.C. wires.







SOCKETS AND RECEPTACLES

CurtiStrip sockets and receptacles can be spaced as close as 2 3/4" o.c. Their two-piece construction simplifies wiring.

Fitting	Cat. No.	Description	Std. Pkg.
 No. 5	5	Standard porcelain socket with shade holder groove....	50
	5-A	Special porcelain socket, no shade holder groove.....	50
 No. 19	19	Nipple attachment for 3/8" conduit or fittings.....	10
	19-BX	Attachment for 1/2" BX or Greenfield.....	10
 No. 20	20	Single Receptacle plate. Takes all standard receptacles.....	10
	23	Duplex Receptacle plate. Takes all standard receptacles	10
 No. 21	21	Switch Plate mounting. Takes standard toggle switch.....	10

CURTISTRIP SUPPORTS

These four standard hangers offer complete flexibility for mounting CurtiStrip.

 No. 9	9	Strap for holding CurtiStrip against any flat surface.....	10
 No. 13	13	Bracket to hang CurtiStrip on pipe or chain hanger.....	10
 No. 24	24	Bracket assembly.....	10
 No. 15	15	Hanger for mounting CurtiStrip on transom bar or side wall.....	10



ADJUSTABLE PORTABLE LAMPS

Dazor Floating Arm Lamps

Float your light exactly where you want it . . . as quickly and easily as you move your arm. Raise, lower, push or pull it; swing it through an arc; twist or turn it at an angle—wherever you stop the reflector it "stays put" until you change the position. The Dazor floating principle is entirely different from that of any other lamp, providing true finger-tip control for maximum convenience.

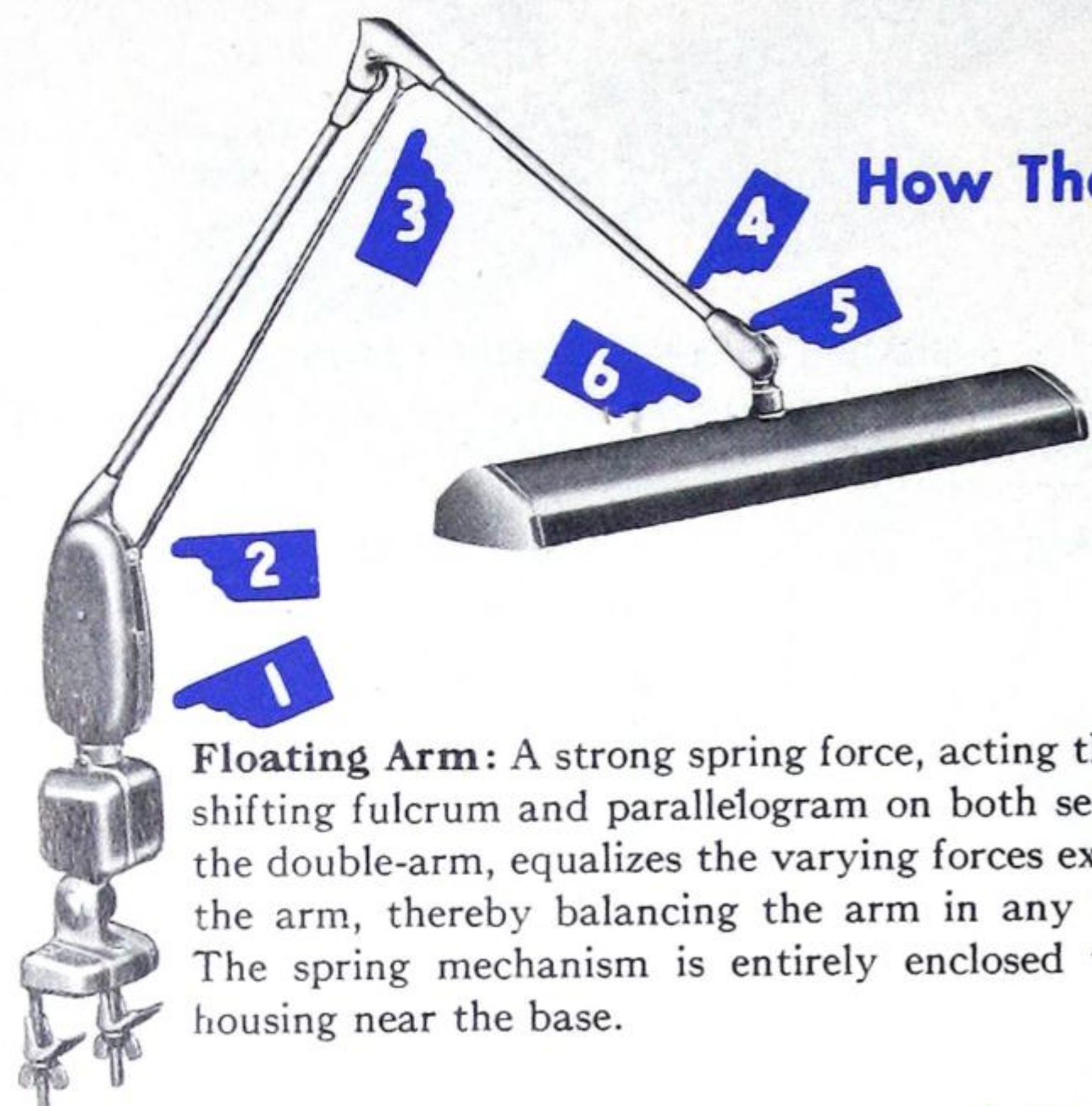

How The Dazor Lamp Gets Its Flexibility

6-Swivel Combination: Six different connections on a Dazor Floating Lamp respond to finger-tip control, together permitting any angular adjustment.

At (1) the main standard swings 305° laterally.

At (2) the arm moves through a vertical arc of 135°.

At (3) the elbow of the arm encloses an arc of 120°.

At (4) the reflector assembly rotates 360° around the arm.

At (5) the reflector assembly moves 185° in the knob of the arm.

At (6) the reflector pivots 305° around the socket.

The floating arm principle, coupled with the double-arm construction and the six swivel and hinge joints described above, results in extreme flexibility and ease of manipulation without further tightening or locking.

4 Standard Base Models

Universal Model: With this combination base the lamp may be clamped or screwed to any surface—horizontal, sloping or vertical. The base is provided with three holes for mounting with screws; when thus screwed in place, the stud, clamping lug and wing nut are not used. A base pad, to prevent the scarring of fine surfaces, and wood screws for mounting are furnished with each unit.

Pedestal Model: A heavy iron base, 12" in diameter, gives stability to this portable floor-type Dazor. Pedestal measures 39" from floor to arm-hinge at top of pedestal. This model is especially adapted to offices, doctors' quarters and homes.

Desk Model: The weighted base of this Dazor Lamp does not require fastening down, permitting it to be placed anywhere on a flat-top desk, table or other horizontal surface; can be moved as desired.

Bracket Model: A goose-neck iron bracket forms the base of this Dazor model. Fastened to under side of drawing board by screws, it leaves upper edge of board clear for T-square, instruments or rolled cover.

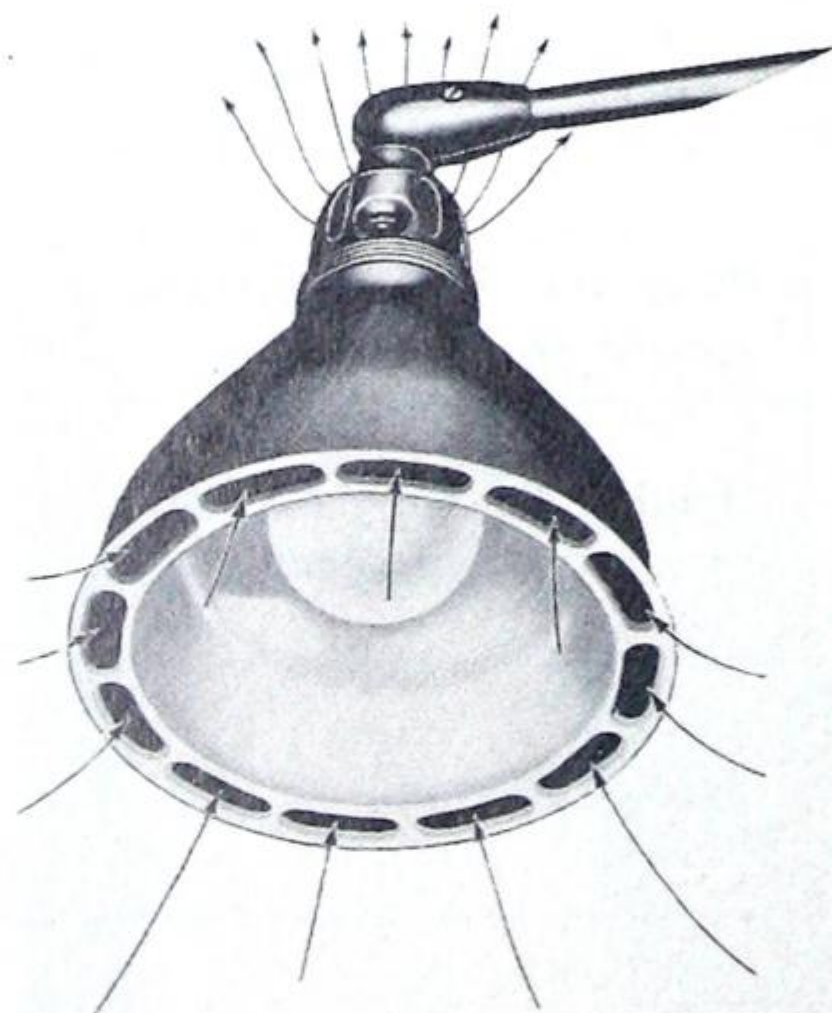

Dazor Air-Cooled Incandescent Shade

AIR FLOWING BETWEEN THE INNER REFLECTOR AND THE OUTER HOUSING CARRIES OFF HEAT. THE SHADE REMAINS COMFORTABLE TO HANDLE AND THERE IS NO RISK OF ACCIDENTAL BURNS. A 60-WATT BULB IS RECOMMENDED.

Dazor Floating Arm Fluorescent Lamps

Dazor Ballasts: In Universal and Bracket Models the ballasts are installed in the rectangular housing just above the base; in Pedestal and Desk Models they are in the lamp base.

Dazor Manual Fluorescent Starter: This is a combination line switch and manual starter built into a single unit. It incorporates the following salient features.

1. Positive action, efficient and durable.
2. No periodic replacements required.
3. Starts fluorescent tubes on a line voltage as low as that on which the tubes themselves will operate.
4. Eliminates blinking of de-activated tubes; upon lamp failure no current flows through the ballast, thus preventing wastage and overheating of the ballast.
5. The Dazor Manual Fluorescent Starter will function and start a tube at any temperature at which the tube itself will function.



ADJUSTABLE PORTABLE LAMPS

Dazor Floating Arm Lamps

Universal Model

Equipped with 2-conductor No. 18 POSJ Midrip Brown Cord, extending 8'9" from the base and a No. 7701 Rubber Cap.

UNIVERSAL MODEL

Arm Extension	Circuit Voltage	Fluorescent		Incandescent	
		Cat. No.	Lamp Watts	Cat. No.	Lamp Watts
24"	110V-60C	P2124-16	2 x 15	3124-A	40 or 60
34"	110V-60C	P2134-16	2 x 15	3134-A	40 or 60

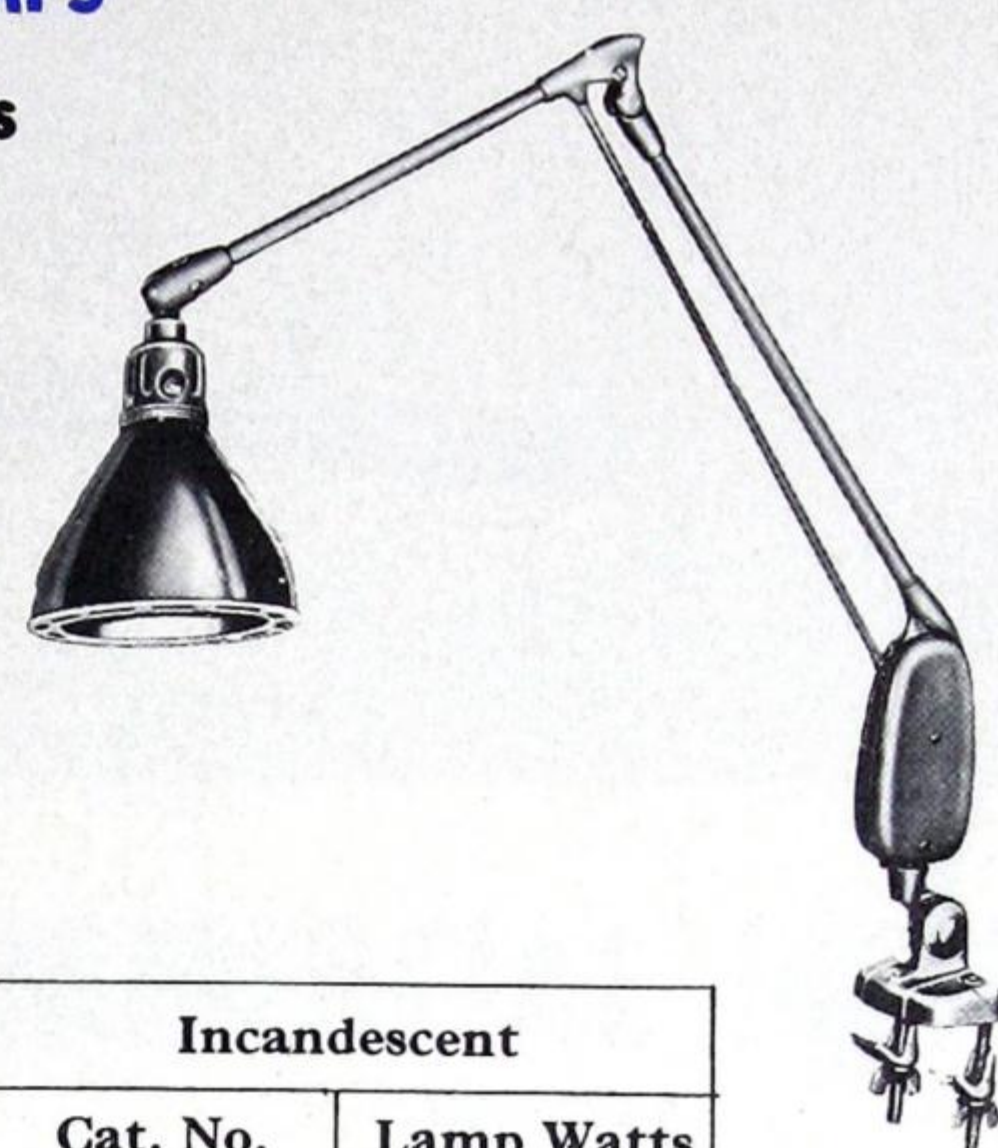
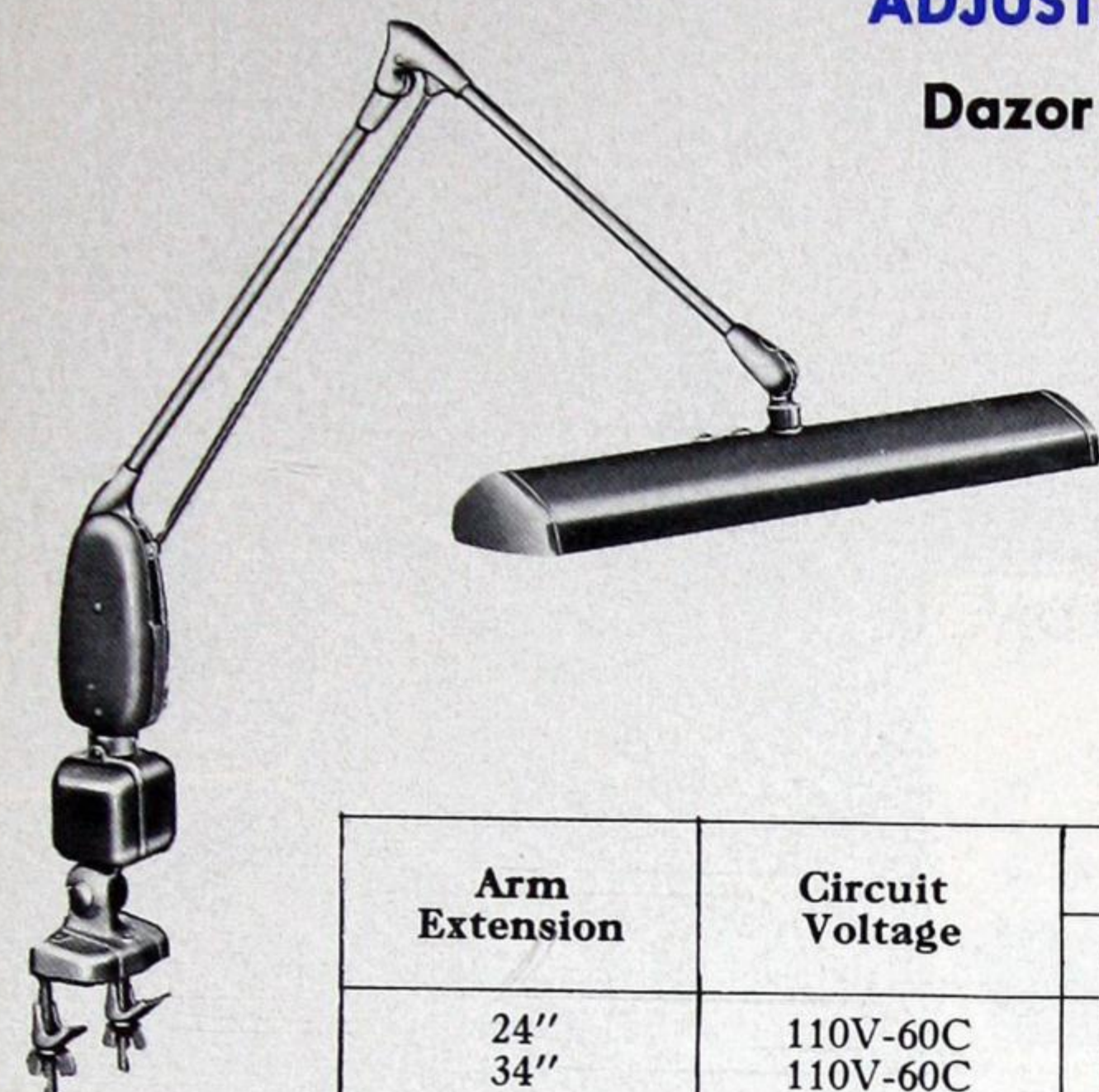

The Universal Model fastens to practically all types of factory or machine shop equipment; lathes, drills, presses, shapers, milling machines, assembly benches, inspection tables. To work benches in garages . . . to repair benches in jewellery, engraving, radio, typewriter and bicycle shops . . . to tables or walls in dental, medical and chemical laboratories . . . to drawing boards. . . to business machines, desks, tables and files in offices . . . to desks and work benches in private homes, basements and garages. The 24" arm extension is recommended for average-size benches, machines, desks and stands; the 34" for drawing boards, executive desks and large working areas. The auxiliary equipment for the fluorescent model is installed in housing beneath the spring mechanism. Standard finish—statuary bronze baked enamel. Inner surface of reflector, white baked enamel.

Pedestal Model

Equipped with 2-conductor No. 18 POSJ Midrip Brown Cord, extending 8'9" from base, and a No. 7701 Rubber Cap.

PEDESTAL MODEL

Arm Extension	Pedestal Height	Circuit Voltage	Fluorescent		Incandescent	
			Cat. No.	Lamp Watts	Cat. No.	Lamp Watts
34"	39"	110V-60C	P2234-16	2 x 15	3234-A	40-60

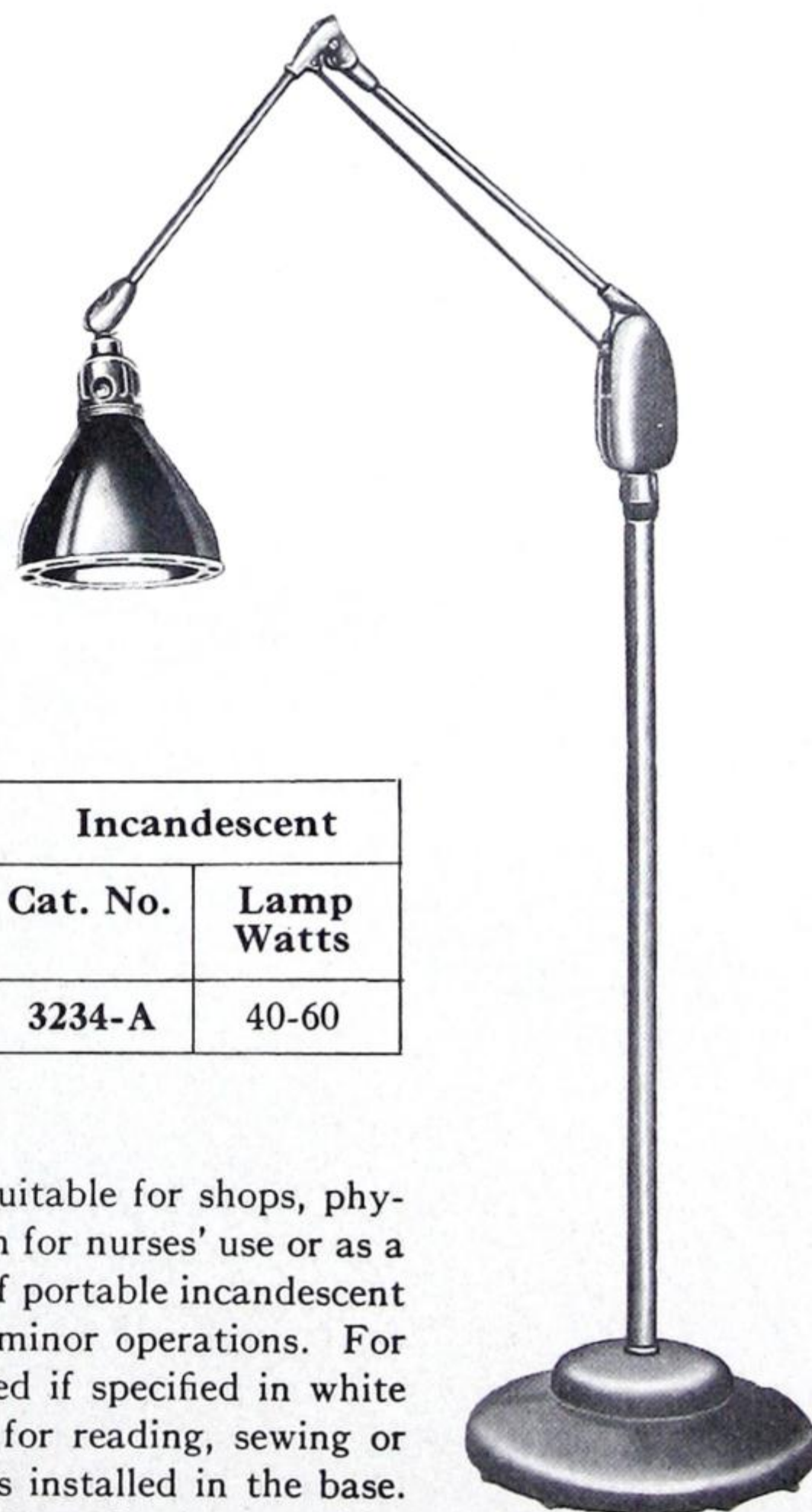
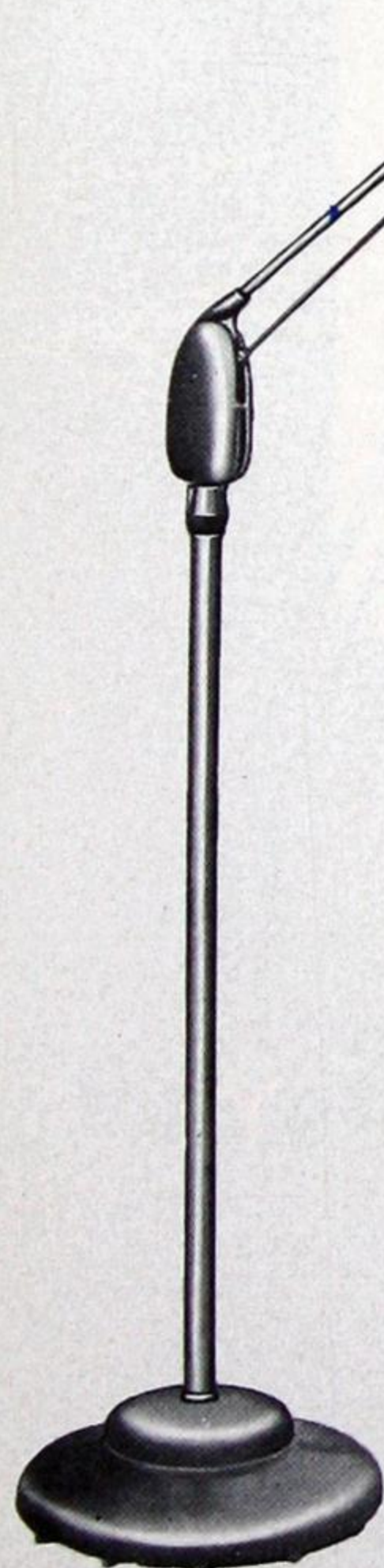

The Pedestal Model is an all purpose floor lamp especially suitable for shops, physicians' offices, studios and homes. It is handy in the sick room for nurses' use or as a patient's night lamp. Special attention is called to the value of portable incandescent light in physicians' offices—for consulting, examination and minor operations. For doctor's use a 75 watt R30 lamp is recommended. Furnished if specified in white baked enamel finish. Use the Pedestal Lamp in the home for reading, sewing or bridge. The auxiliary equipment for the fluorescent model is installed in the base. Standard finish—Statuary Bronze baked enamel. Inner surface of reflector, white baked enamel.



ADJUSTABLE PORTABLE LAMPS

Dazor Floating Arm Lamps

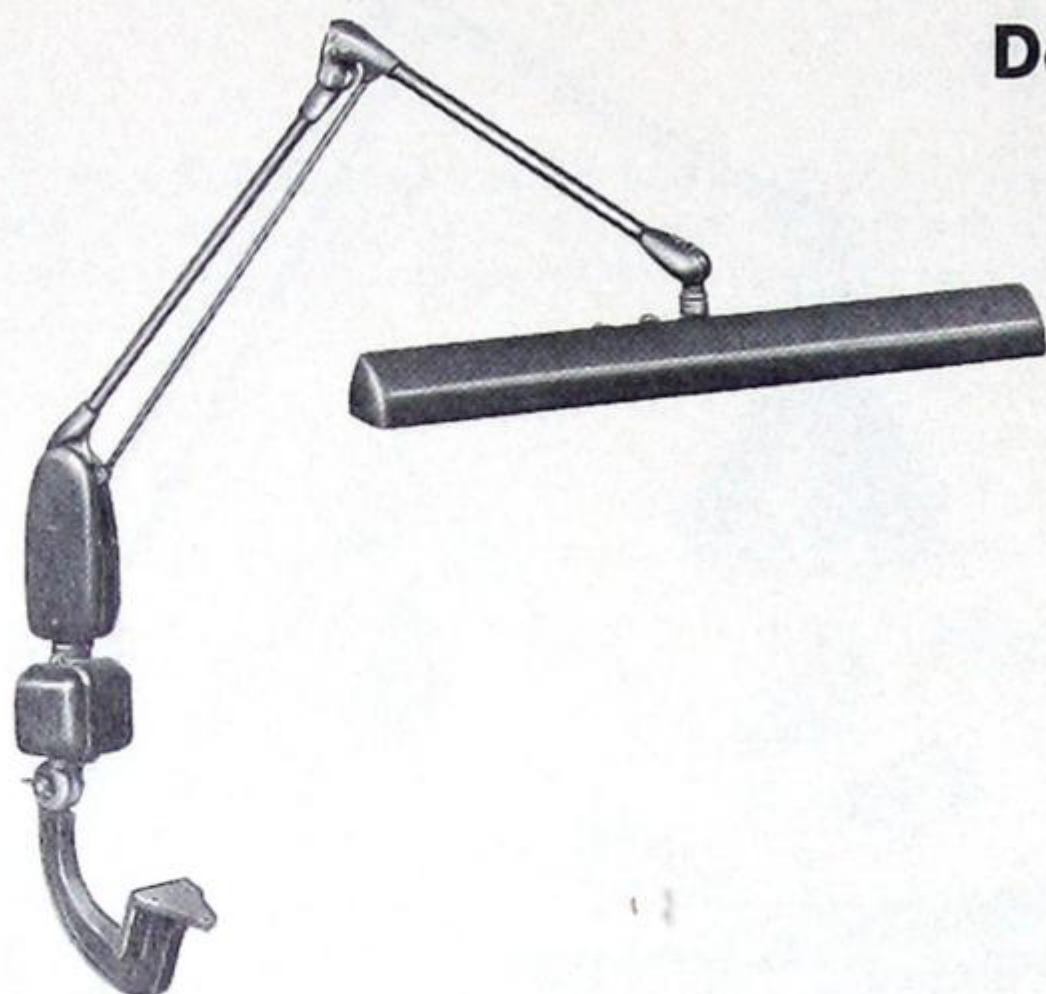

Bracket Model

Equipped with 2-conductor No. 18 POSJ Midrip Brown Cord, extending 8'9" from base, and a No. 7701 Rubber Cap.



BRACKET MODEL

Arm Extension	Circuit Voltage	Fluorescent		Incandescent	
		Cat. No.	Lamp Watts	Cat. No.	Lamp Watts
34"	110V-60C	P2434-16	2 x 15	3434-A	40 or 60

The Bracket Model provides convenient, easily directed light for architects, draftsmen and artists. The goose-neck base attaches with screws to under side of drawing board, leaving top of board entirely free of obstruction. T-square may be used along upper edge and board cover may be rolled into hollow of the goose-neck fitting. This base is also adaptable to certain benches and machines. The auxiliary equipment for the fluorescent model is installed in housing beneath the spring mechanism. Standard finish—statuary bronze baked enamel. Inner surface of reflector, white baked enamel.

Desk Model

Equipped with 2-conductor No. 18 POSJ Midrip Brown Cord, extending 8'9" from base, and a No. 7701 Rubber Cap.



DESK MODEL

Arm Extension	Circuit Voltage	Fluorescent		Incandescent	
		Cat. No.	Lamp Watts	Cat. No.	Lamp Watts
24"	110V-60C	P2324-16	2 x 15	3324-A	40 or 60

The Desk Model is portable, requiring no screws or clamps; base is weighted to support the floating arm in any position while resting on any level desk, table or stand. Convenient for flat-top desks of executives, architects, accountants, clerks. For slanting surfaces, such as drawing boards, specify the Universal or Bracket Model. The auxiliary equipment for the fluorescent model is installed in the base. Standard finish—statuary bronze baked enamel. Inner surface of reflector, white baked enamel.

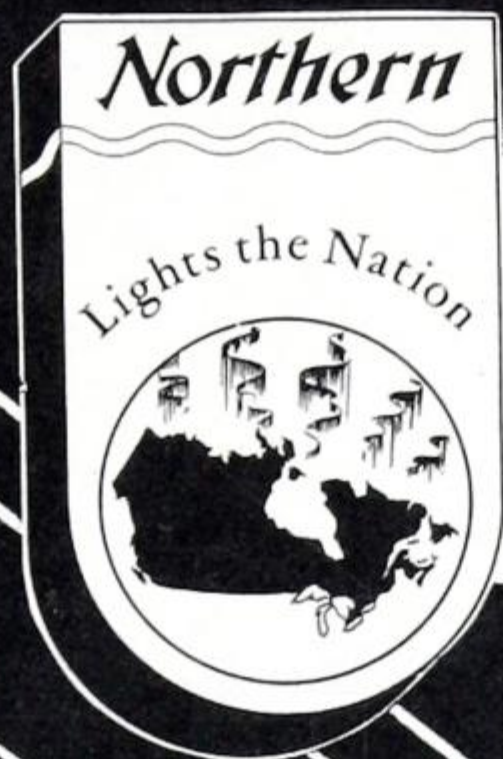
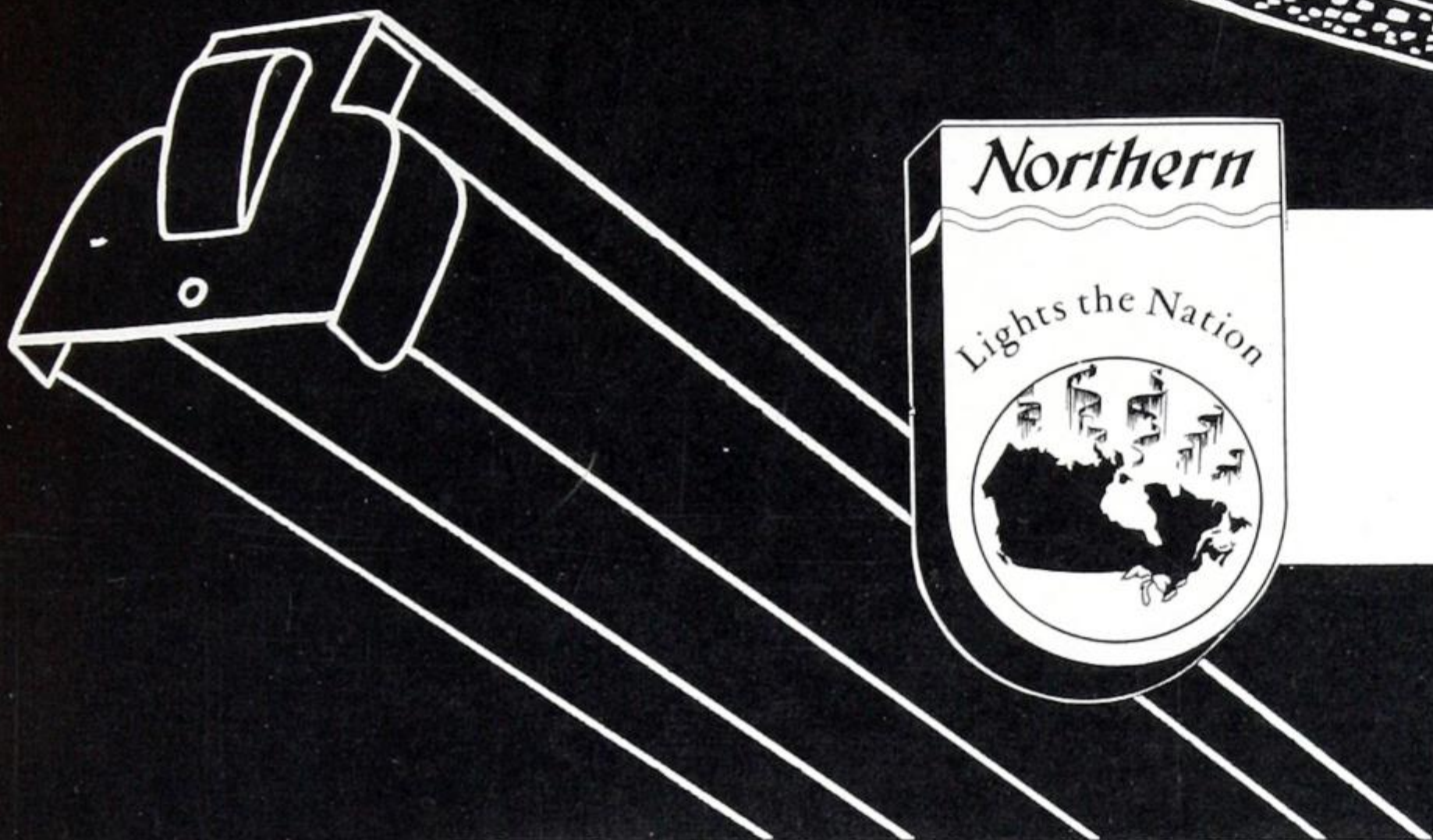
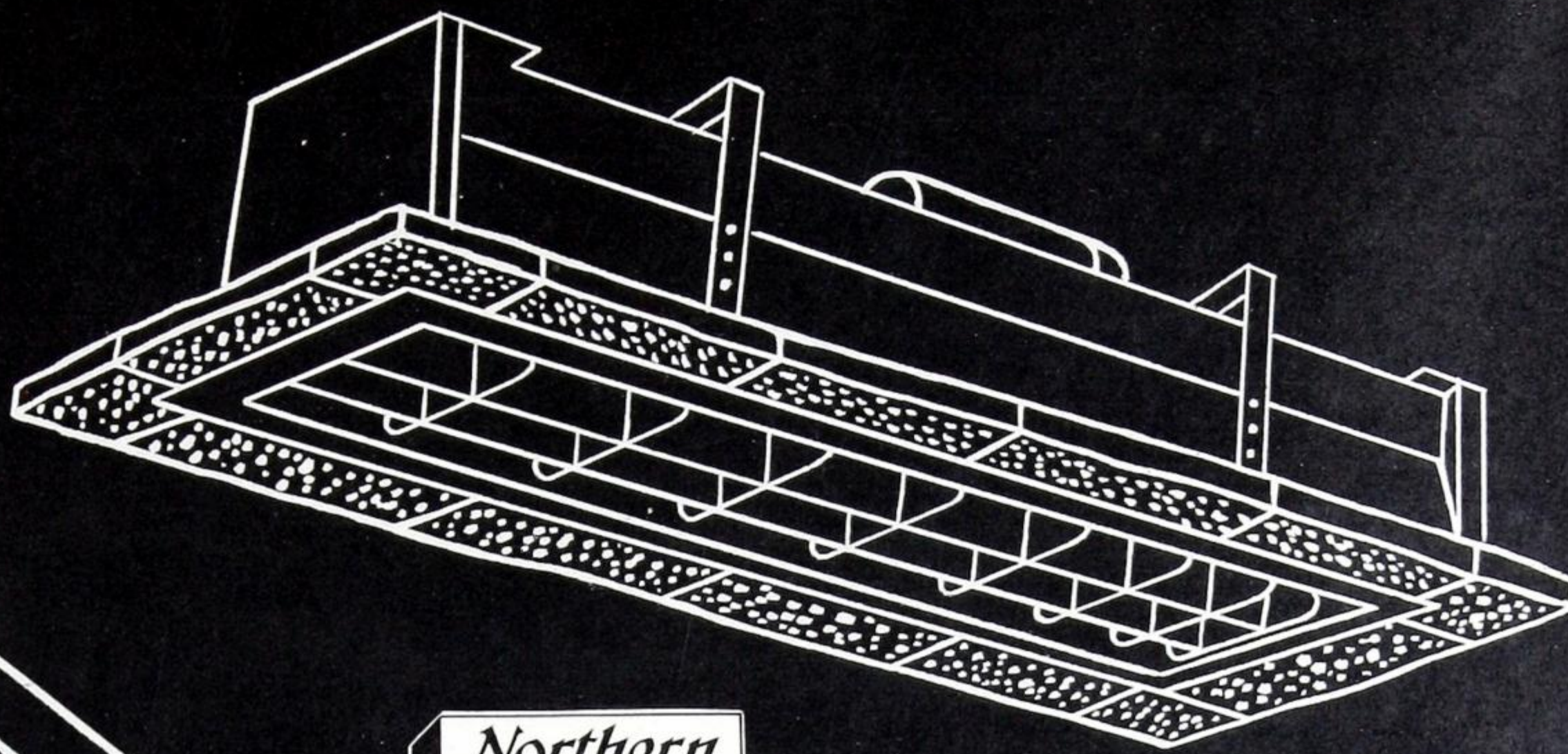

COMMERCIAL LIGHTING

(FLUORESCENT)

CONTENTS

Design Data for Commercial Lighting	36
Open-type Units	108
Shielded Units	113
Luminous Ceilings	148
Light and Sound Conditioning	151
Strip Lighting Units	153
Show-window Units	161
Cove Lighting Units — Fluorescent	161
Direction Signs and Brackets	160
Showcase Units	162
Recessed Troffers	163
Shallow Recessed Troffers	172

Use the

Northern Electric Lighting Service



FLUORESCENT OPEN TYPE UNITS

Day-Brite "Topnotch-2" Units

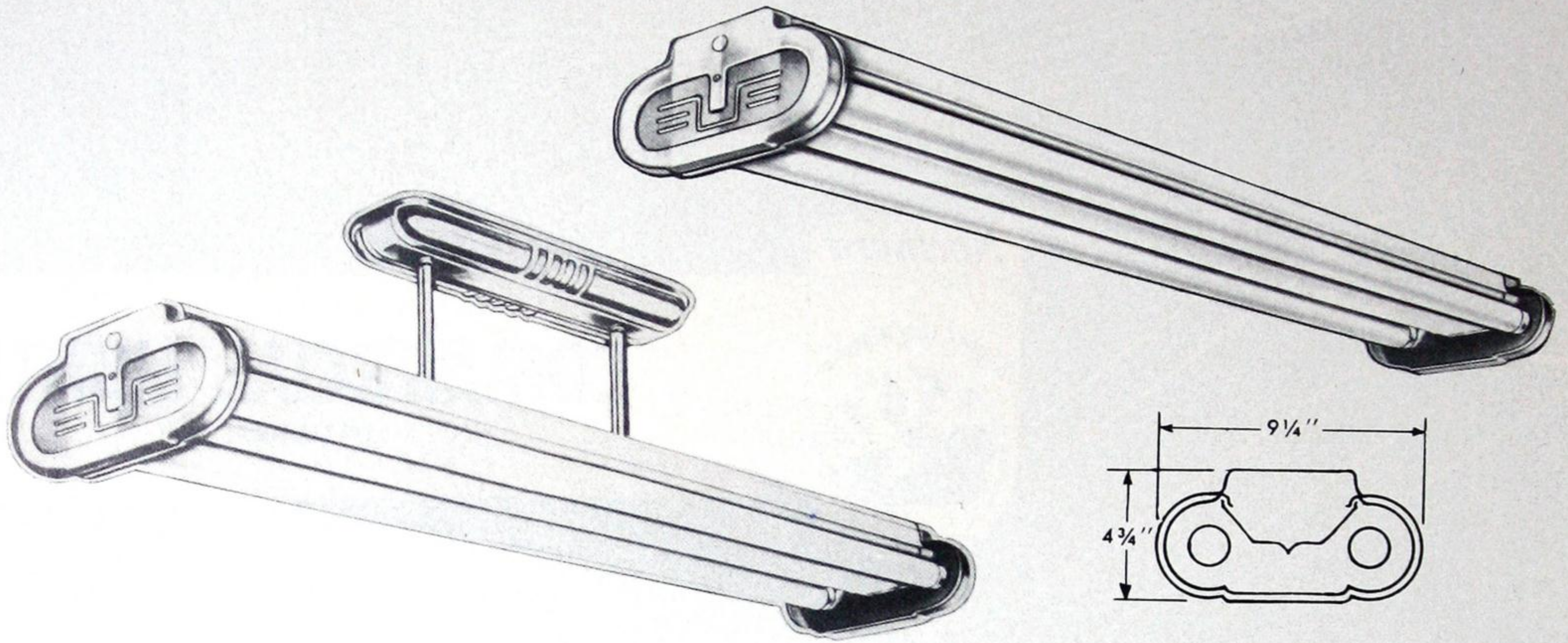

Complete open type units for two 40 watt fluorescent lamps. These lighting units have many applications. They are efficient and easy to install and maintain. They are designed for both surface and suspension mounting.

CHASSIS—The chassis is steel, of die-formed and welded construction. The wireway cover snaps into position on the chassis and is easily removed for access to wiring and sockets. The entire chassis is finished in baked Super-White enamel.

END PLATES—The decorative end plates are of die-formed steel and are available in baked Metallic Grey, or baked Super-White enamel. They are supported on the chassis by a single screw and do not have to be removed for relamping.

MOUNTING—Chassis is arranged for either surface or suspension mounting. The chassis is provided with all necessary holes and knockouts for quick fastening to ceiling or for suspension mounting and for wire connections.

ADAPTABILITY—The basic chassis for the "Topnotch-2", "Viz-Aid-2", and "Lenox-2" is identically the same. It is therefore possible to equip an initial installation of bare lamp "Topnotch-2" units with either the "Viz-Aid-2" or "Lenox-2" enclosure at any time thus providing the added advantages of improved appearance and adequate shielding.

WIRING—All units are furnished wired and supplied with best quality fully compensated standard 2 x 40 watt ballasts, ensuring efficient starting and maximum lamp life and light output. They are equipped with standard type lamp and starter sockets, and standard starters. Automatic or manual reset starters will be supplied if specified.

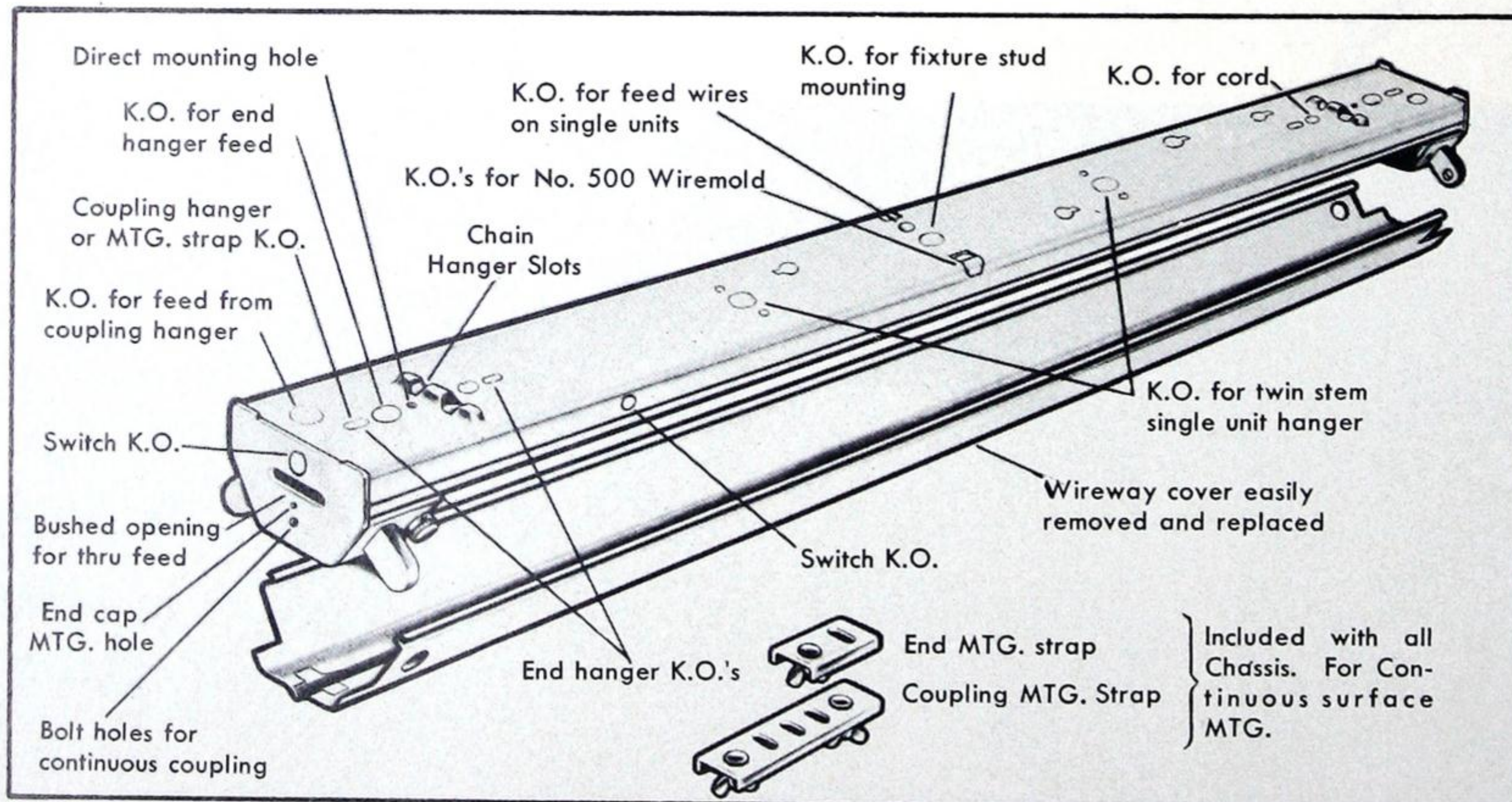

BASIC CHASSIS

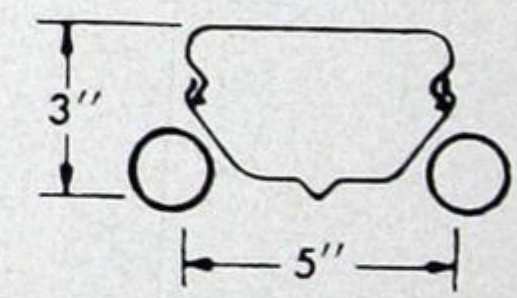

DECORATIVE END PLATES

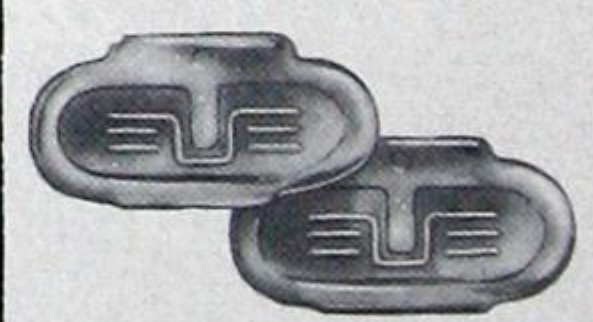

Included with all Chassis. For Continuous surface MTG.



FLUORESCENT OPEN TYPE UNITS

Day-Brite "Topnotch-2" Units

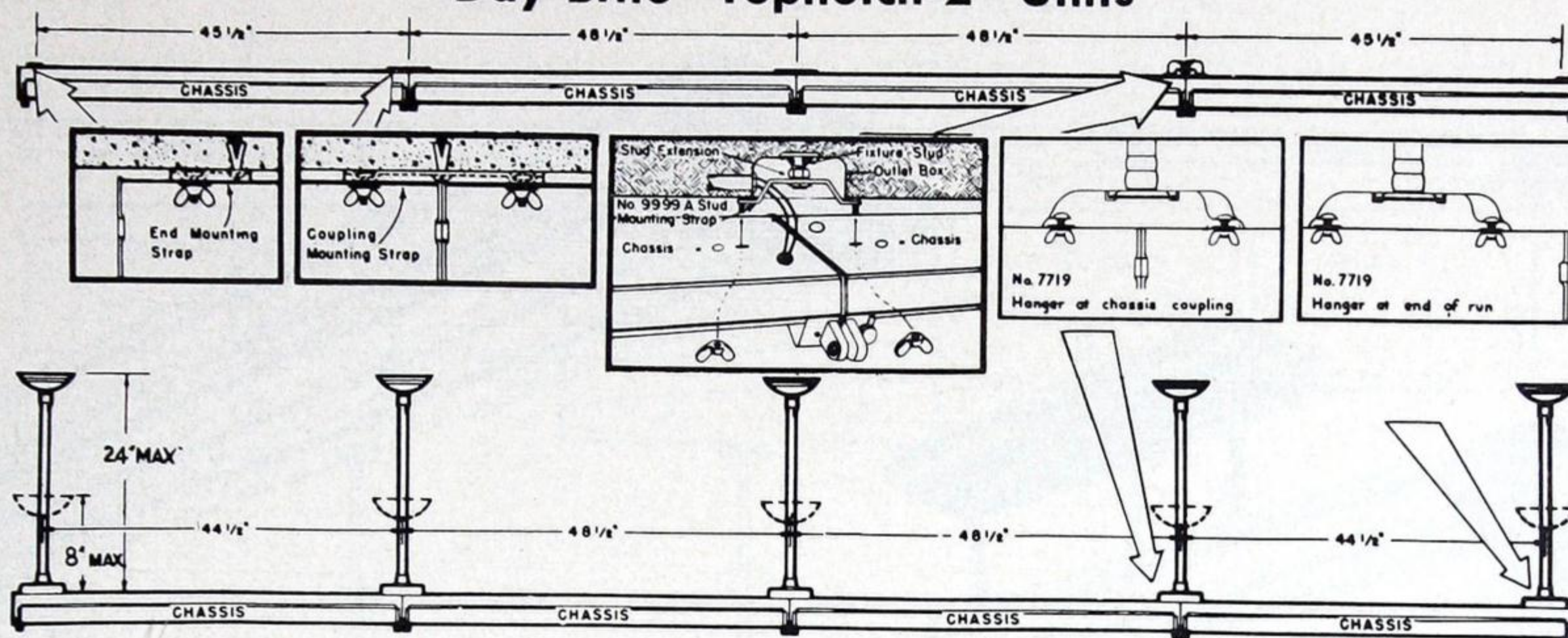

SPACING 1.5xMH		EFF 89.5%	
M.F.	"TOPNOTCH-2" SURFACE	14.30% ↑	
G.80		75.20% ↓	
M.75			
P.70			
CEILING	75%		50%
WALLS	50%	30%	10%
ROOM INDEX	COEFFICIENT OF UTILISATION		
J	.30	.27	.23
I	.41	.35	.34
H	.45	.40	.36
G	.49	.44	.40
F	.52	.48	.43
E	.58	.54	.51
D	.63	.58	.54
C	.66	.61	.56
B	.71	.65	.63
A	.73	.68	.64

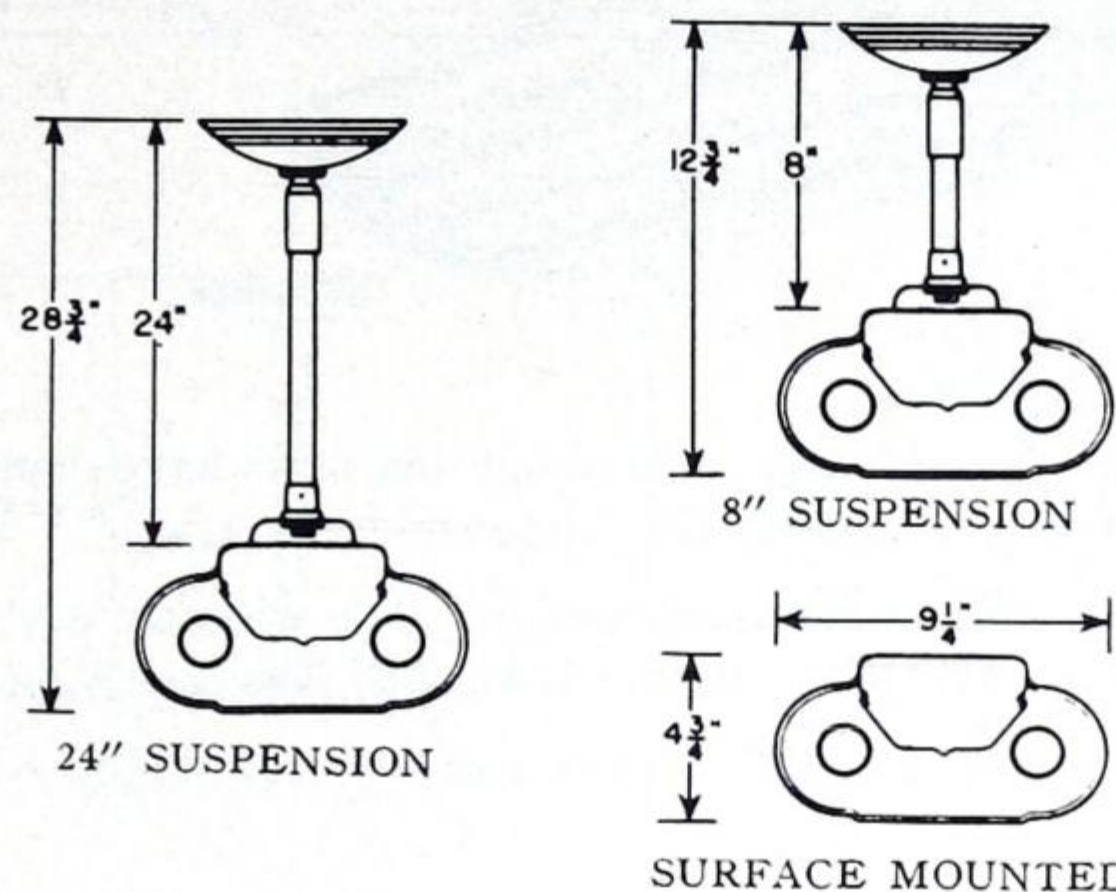

SPACING 1.5xMH		EFF 91.0%	
M.F.	"TOPNOTCH-2" SUSPENSION	30.0% ↑	
G.80		61.0% ↓	
M.75			
P.70			
CEILING	75%		50%
WALLS	50%	30%	10%
ROOM INDEX	COEFFICIENT OF UTILISATION		
J	.30	.25	.22
I	.38	.33	.27
H	.43	.37	.34
G	.47	.42	.38
F	.51	.45	.41
E	.56	.51	.46
D	.60	.55	.50
C	.64	.58	.53
B	.67	.62	.59
A	.70	.65	.61

Individual "Topnotch-2" Units

Catalogue No.*	Lamps	Cycles	Components			Overall Length
			Chassis	End Plates	Mounting Straps	
46200-60**	2x40W	60	9987-60	2 No. 9997	1 pair	48 1/2"
46200-60-IS†	2x40W	60	9987-60-IS	2 No. 9997	1 pair	48 1/2"

*With baked Metallic Grey end plates. For white end plates add suffix "W" to unit Catalogue No. †Instant start.
 **For 25 cycle operation, units with dual frequency 25/60 cycle ballasts will be supplied if specified.

Continuous Rows

No. of Units	Cat. No.* Complete Row	Total No. of Lamps	Cycles**	Components			Hangers Required†		Overall Length of Row
				Chassis*	End Plates	Mounting Straps	Single Stem 8" or 24"	Double Stem	
2	46200-60-8	4 x 40W	60	2 No. 9987-60	2 No. 9997	2 Pair	3	2	8'1"
3	46200-60-12	6 x 40W	60	3 No. 9987-60	2 No. 9997	3 Pair	4	3	12'1 1/2"
4	46200-60-16	8 x 40W	60	4 No. 9987-60	2 No. 9997	4 Pair	5	4	16'2"
5	46200-60-20	10 x 40W	60	5 No. 9987-60	2 No. 9997	5 Pair	6	5	20'2 1/2"
6	46200-60-24	12 x 40W	60	6 No. 9987-60	2 No. 9997	6 Pair	7	6	24'3"
7	46200-60-28	14 x 40W	60	7 No. 9987-60	2 No. 9997	7 Pair	8	7	28'3 1/2"
8	46200-60-32	16 x 40W	60	8 No. 9987-60	2 No. 9997	8 Pair	9	8	32'4"

*For Instant Start 60 cycle operation add suffix "IS" to Complete Row or Chassis Catalogue No. †Specify separately—See below.
 With baked Metallic Grey end plates. For white end plates add suffix "W" to Complete Row Catalogue No.
 **For 25 cycle operation, units with dual frequency 25/60 cycle ballasts will be supplied if specified.

Hanger Cat. Nos.

Description	Double Stem Adjustable 24" Standard†*	Single Stem Adjustable 8"*	Single Stem Adjustable 24"*
Metallic Grey	9925	7789	7719
White Enamel	9925W	7789W	7719W
Stud Mounting Strap	9999A	For mounting and connecting chassis with outlet box at chassis coupling.	

*Special length hangers will be supplied if specified. †If used with dual frequency units, specify with No. 9925A adapter.



FLUORESCENT OPEN TYPE UNITS

Day-Brite "Topnotch-4" Units



Complete open type units for four 40 watt fluorescent lamps. These lighting units have many applications. They are efficient and easy to install and maintain. They are designed for both surface and suspension mounting.

CHASSIS—The chassis is steel, of die formed and welded construction. The wireway cover snaps into position on the chassis and is easily removed for access to wiring and sockets. The entire chassis is finished in baked Super-White enamel.

END PLATES—The decorative end plates are of die formed steel and are available in baked Metallic Grey, or baked Super-White enamel.

MOUNTING—Chassis is arranged for either surface or suspension mounting. The chassis is provided with all necessary holes and knockouts for quick fastening to ceiling or for suspension mounting and for wire connections.

ADAPTABILITY—The basic chassis for the "Topnotch-4", "Viz-Aid-4" and "Lenox-4" is identically the same. It is therefore possible to equip an initial installation of bare lamp "Topnotch-4" units with either the "Viz-Aid-4" or "Lenox-4" enclosure at any time, thus providing the added advantages of improved appearance and adequate shielding.

WIRING—All units are furnished wired and supplied with best quality fully compensated standard 2 x 40 watt ballasts, ensuring efficient starting and maximum lamp life and light output. They are equipped with standard type lamp and starter sockets, and standard starters. Automatic or manual reset starters will be supplied if specified.

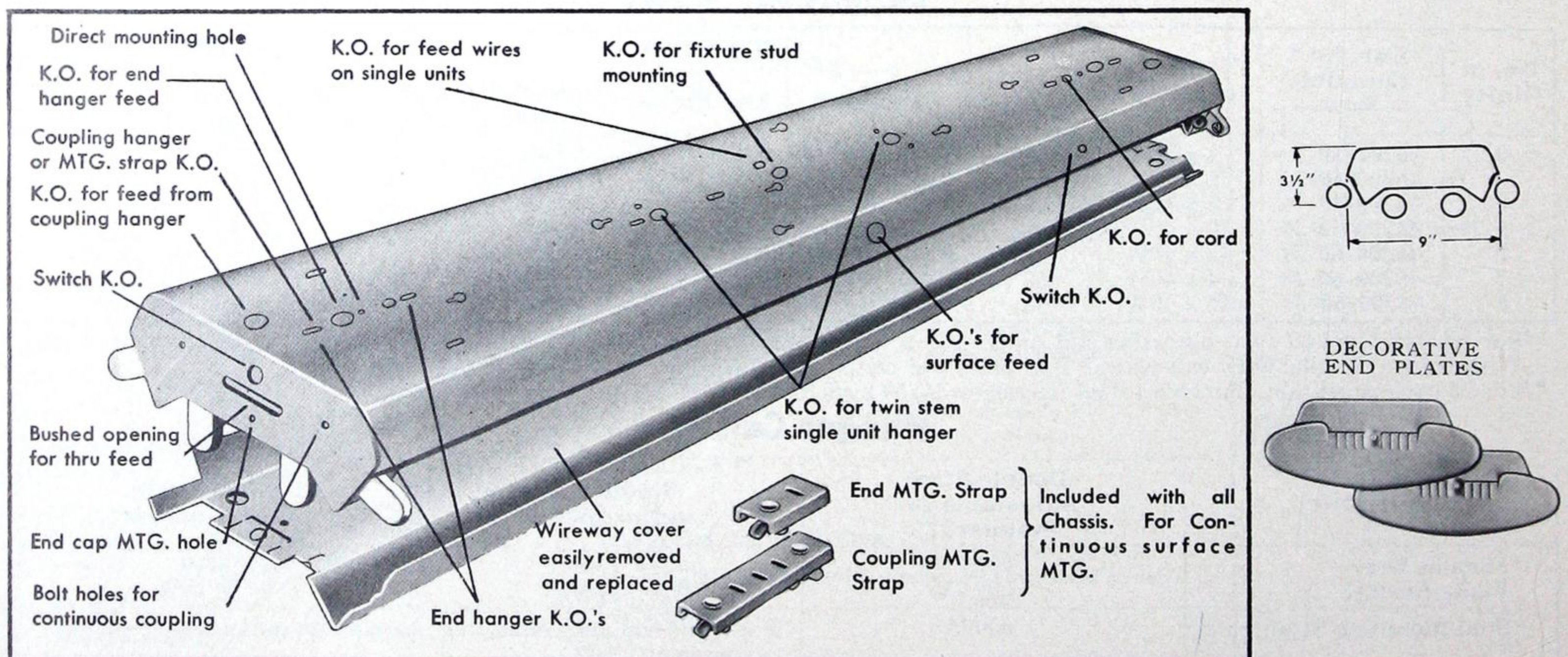

BASIC CHASSIS



FLUORESCENT OPEN TYPE UNITS

Day-Brite "Topnotch-4" Units

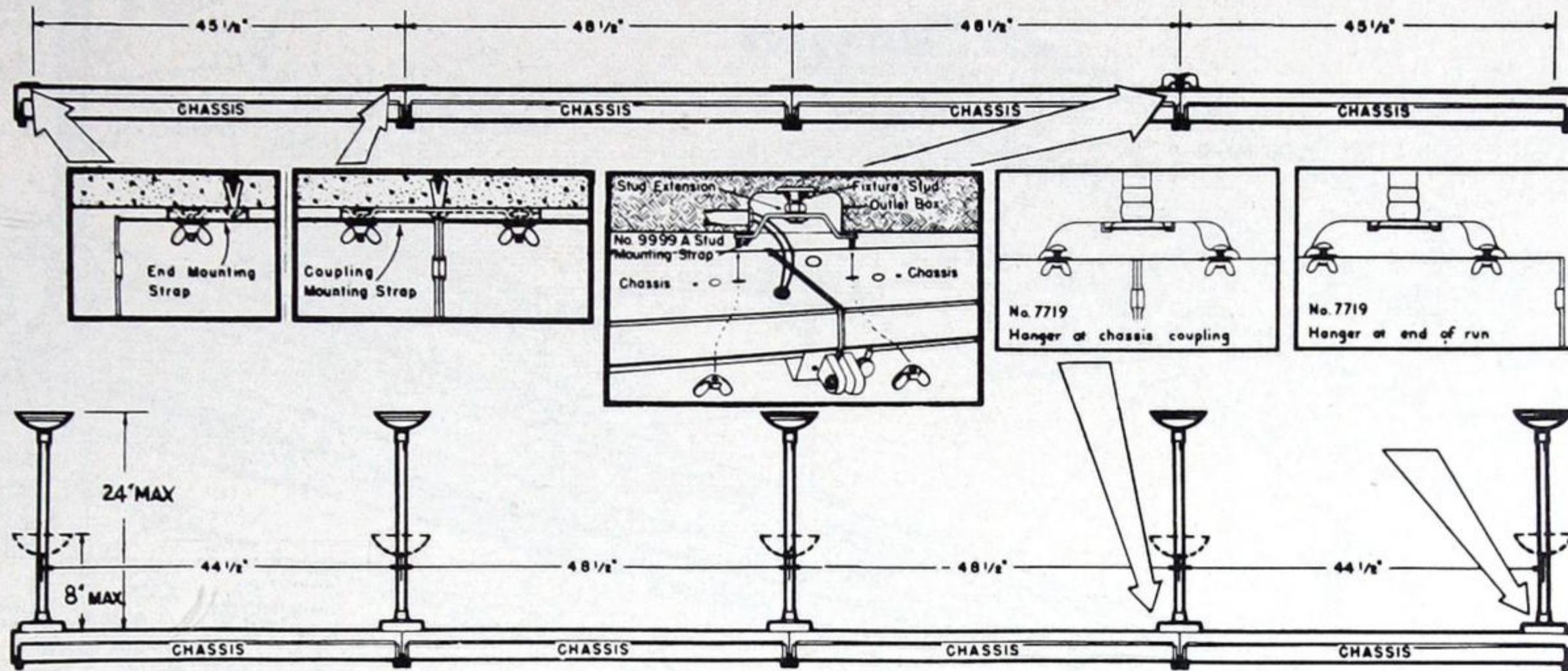

SPACING 1.5xMH		EFF 82.0%	
M.F.	"TOPNOTCH-4"	12.0%	
G.80	SURFACE	70.0%	
M.75			
P.70			
CEILING	75%	50%	
WALLS	50% 30% 10%	50% 30% 10%	
ROOM INDEX	COEFFICIENT OF UTILISATION		
J	.31	.26	.22
I	.39	.34	.31
H	.44	.38	.36
G	.48	.44	.39
F	.51	.46	.42
E	.56	.52	.48
D	.60	.56	.53
C	.63	.59	.55
B	.67	.63	.58
A	.68	.65	.62

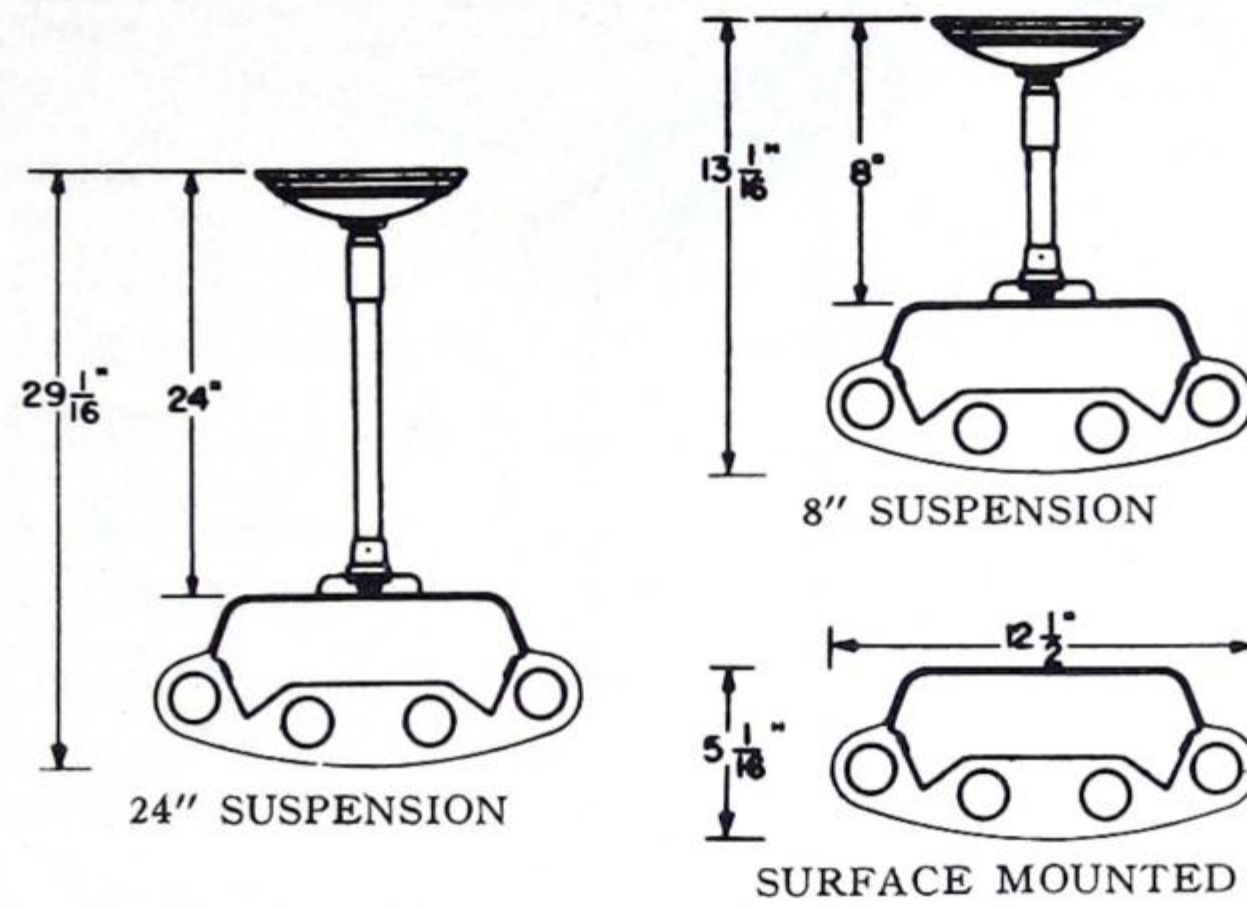

SPACING 1.5xMH		EFF 86.0%	
M.F.	"TOPNOTCH-4"	18.0%	
G.80	SUSPENSION	68.0%	
M.75			
P.70			
CEILING	75%	50%	
WALLS	50% 30% 10%	50% 30% 10%	
ROOM INDEX	COEFFICIENT OF UTILISATION		
J	.32	.26	.22
I	.40	.35	.31
H	.44	.39	.36
G	.48	.44	.40
F	.52	.47	.43
E	.57	.53	.49
D	.61	.57	.53
C	.65	.60	.56
B	.68	.64	.60
A	.70	.66	.63

Individual "Topnotch-4" Units

Catalogue No.*	Lamps	Cycles	Components			Overall Length
			Chassis	End Plates	Mounting Straps	
46422-60**	4x40W	60	7790-60	2 No. 7791	1 Pair	49 1/4"
46422-60-IS†	4x40W	60	7790-60-IS	2 No. 7791	1 Pair	49 1/4"

*With baked Metallic Grey end plates. For white end plates add suffix "W" to unit Catalogue No. †Instant start.
 **For 25 cycle operation, units with dual frequency 25/60 cycle ballasts will be supplied if specified.

Continuous Rows

No. of Units	Cat. No.* Complete Row	Total No. of Lamps	Cycles**	Components			Hangers Required†		Overall Length of Row
				Chassis*	End Plates	Mounting Straps	Single Stem 8" or 24"	Double Stem	
2	46422-60-8	8 x 40W	60	2 No. 7790-60	2 No. 7791	2 Pair	3	2	8' 1 3/4"
3	46422-60-12	12 x 40W	60	3 No. 7790-60	2 No. 7791	3 Pair	4	3	12' 2 1/4"
4	46422-60-16	16 x 40W	60	4 No. 7790-60	2 No. 7791	4 Pair	5	4	16' 2 3/4"
5	46422-60-20	20 x 40W	60	5 No. 7790-60	2 No. 7791	5 Pair	6	5	20' 3 1/4"
6	46422-60-24	24 x 40W	60	6 No. 7790-60	2 No. 7791	6 Pair	7	6	24' 3 3/4"
7	46422-60-28	28 x 40W	60	7 No. 7790-60	2 No. 7791	7 Pair	8	7	28' 4 1/4"
8	46422-60-32	32 x 40W	60	8 No. 7790-60	2 No. 7791	8 Pair	9	8	32' 4 3/4"

*For Instant start 60 cycle operation add suffix "IS" to Complete Row or Chassis Catalogue No. †Specify separately—See below.
 With baked Metallic Grey end plates. For white end plates suffix "W" to Complete Row Catalogue No.
 **For 25 cycle operation, units with dual frequency 25/60 cycle ballasts will be supplied if specified, not available for instant start.

Hanger Cat Nos.

Description	Double Stem Adjustable 24" Standard†*	Single Stem Adjustable 8"***	Single Stem Adjustable 24"***
Metallic Grey	9925	7789	7719
White Enamel	9925W	7789W	7719W
Stud Mounting Strap	9999A	For mounting and connecting chassis with outlet box at chassis coupling.	

*Special length hangers will be supplied if specified.

†If used with dual frequency units specify with No. 9925A adapter.



FLUORESCENT OPEN TYPE UNITS

Day-Brite "Topnotch" Units

Hangers

"TOPNOTCH-2"—CONTINUOUS ROW

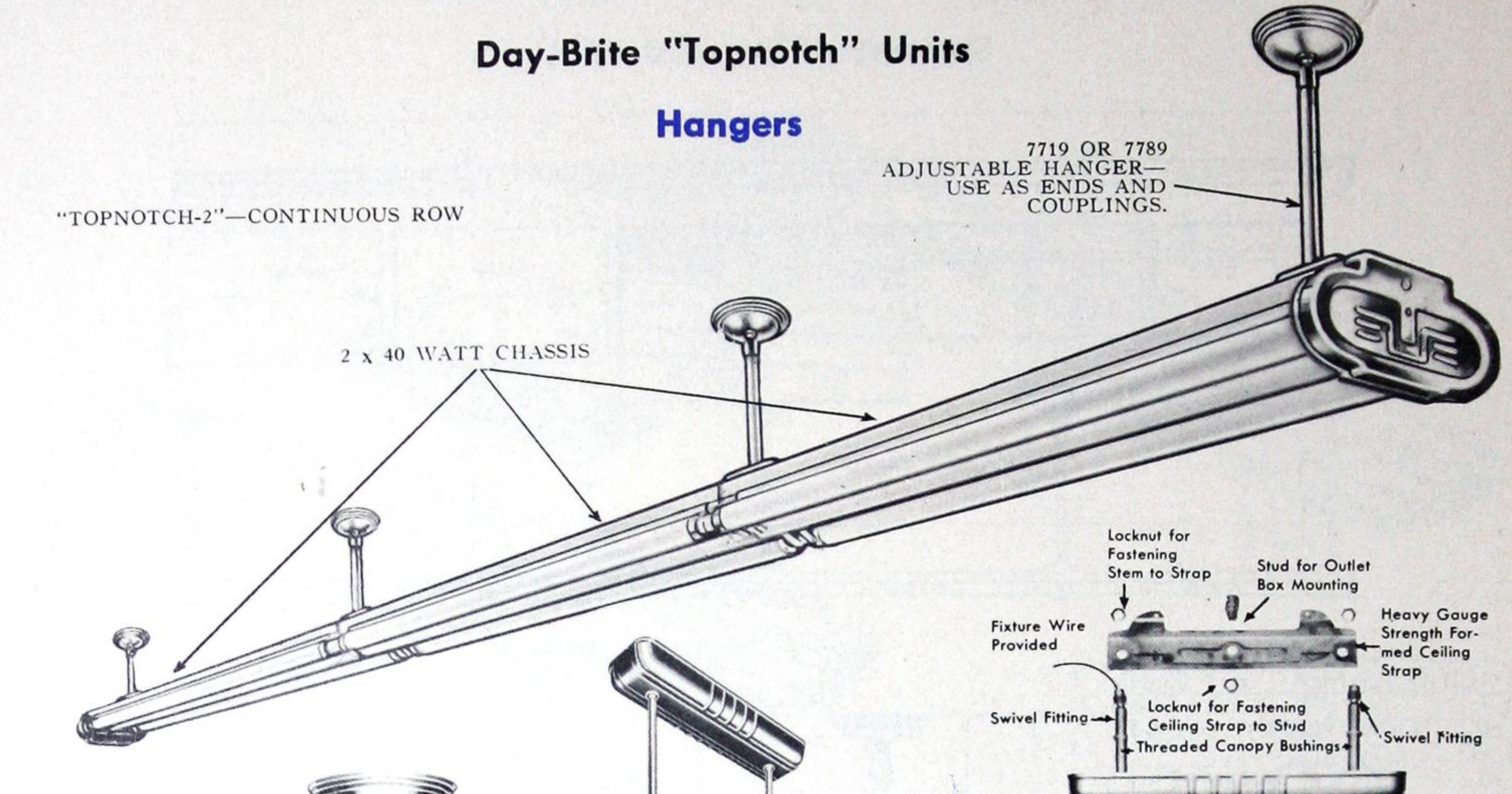

No. 7789-8"

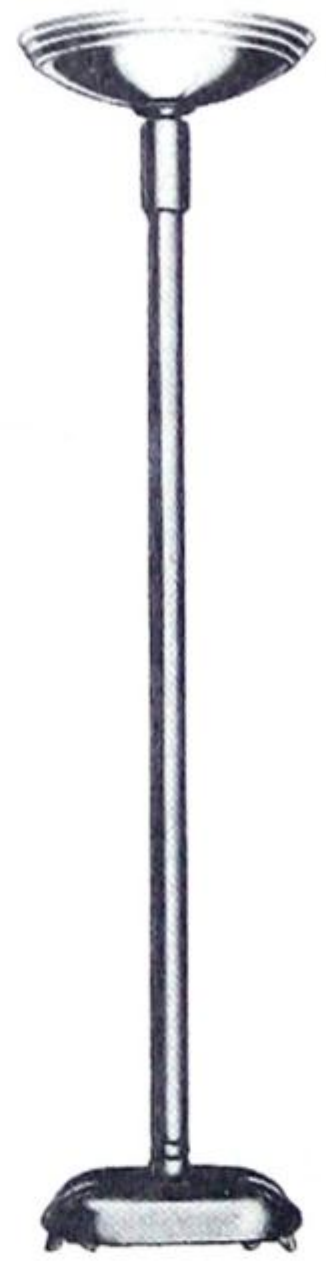

No. 7719-24"

DOUBLE STEM 24" HANGER—STANDARD No. 9925



No. 9999-A—STUD MOUNTING STRAP For mounting and connecting chassis with outlet box at chassis coupling.

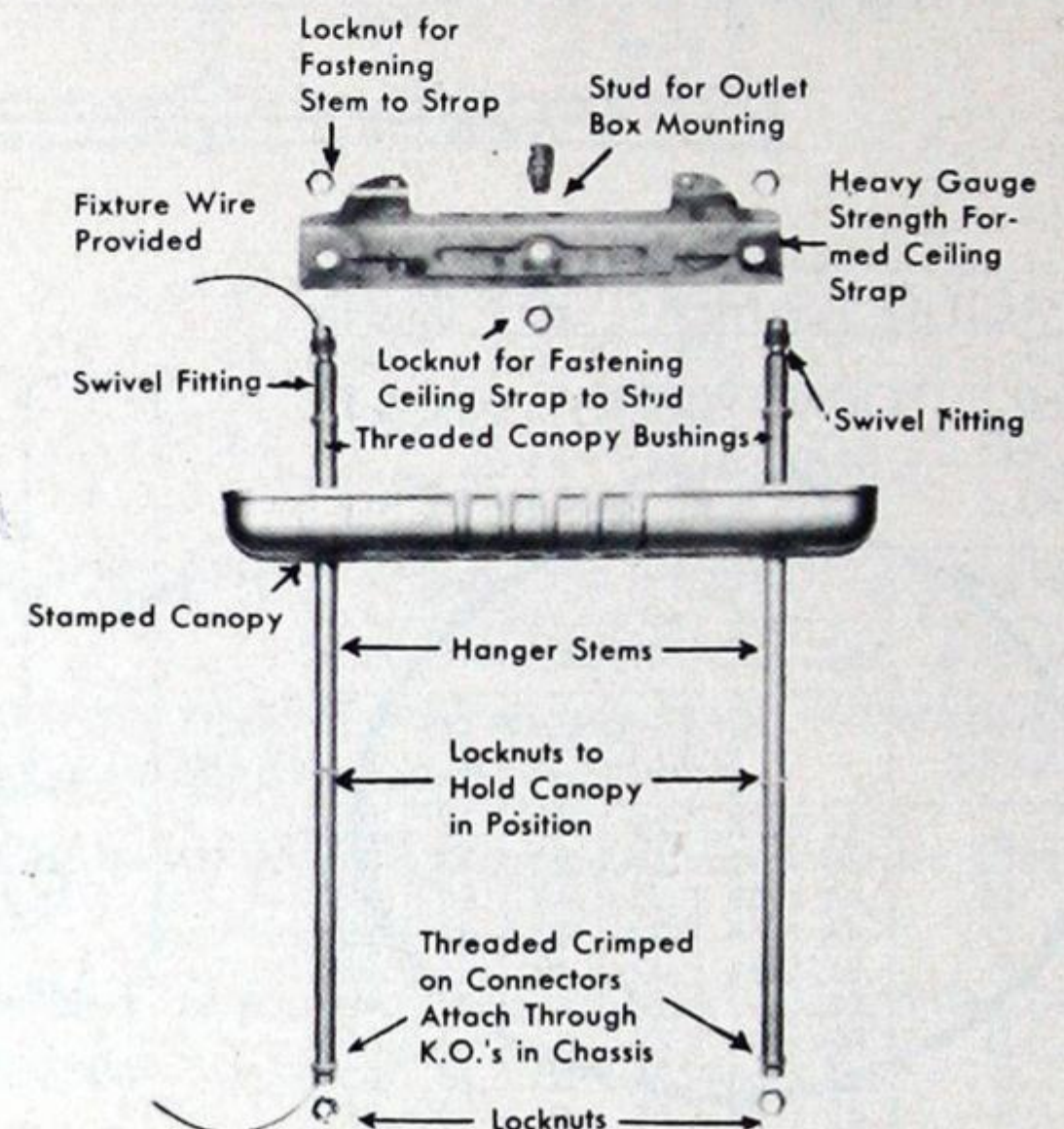

No. 9925 EXPANDED VIEW

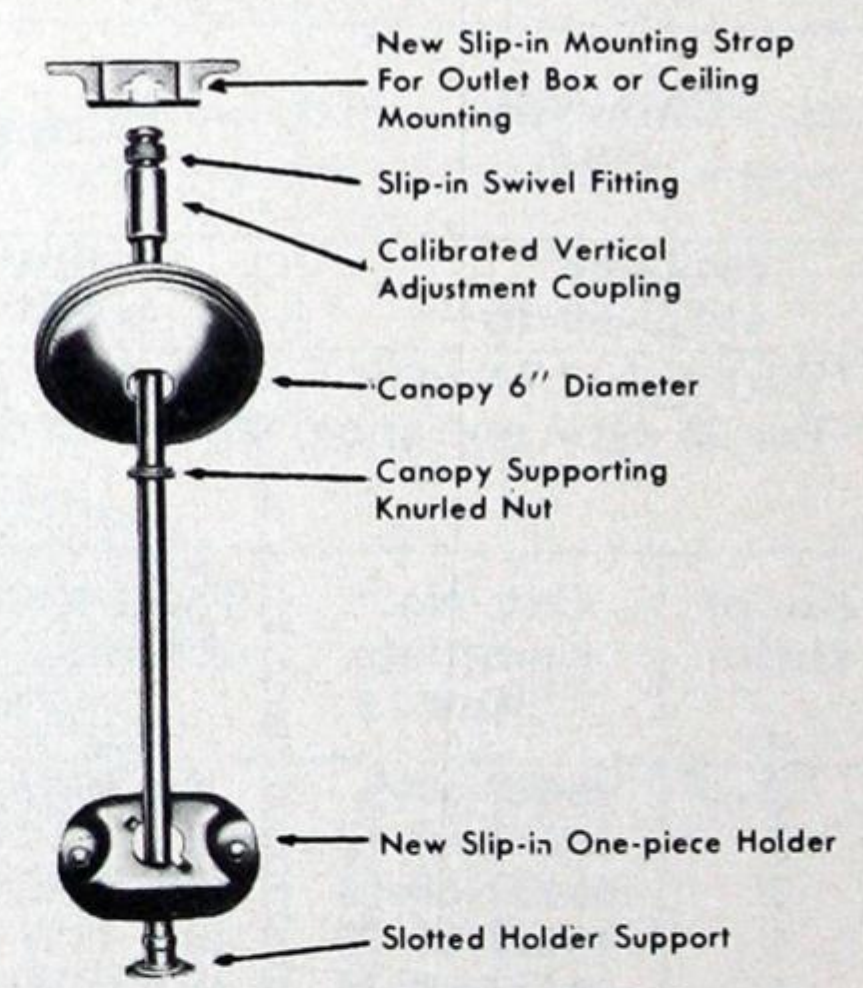

No. 7789, 7719 EXPANDED VIEW

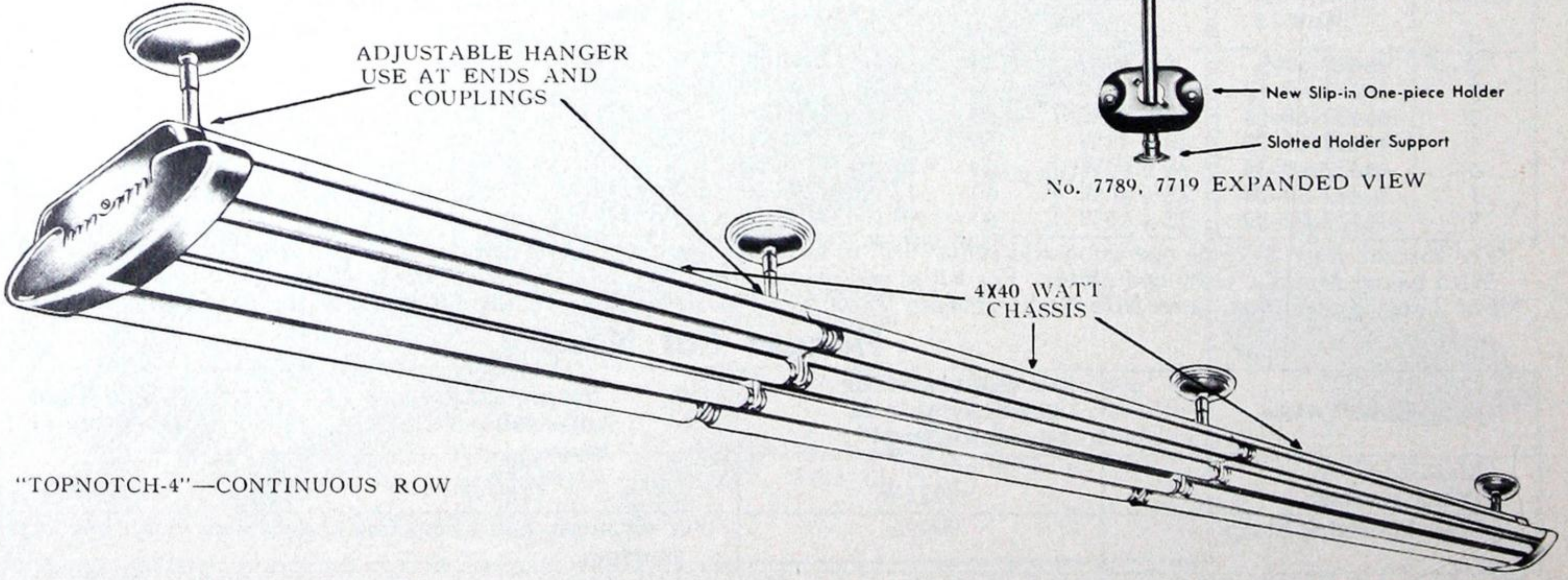

"TOPNOTCH-4"—CONTINUOUS ROW



FLUORESCENT SHIELDED UNITS

Day-Brite "Viz-Aid-2" Units

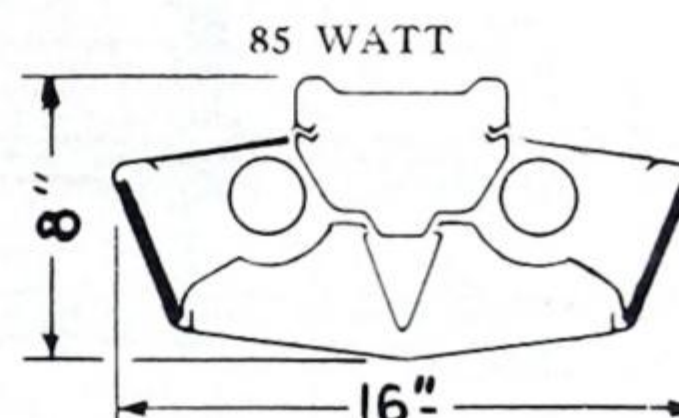
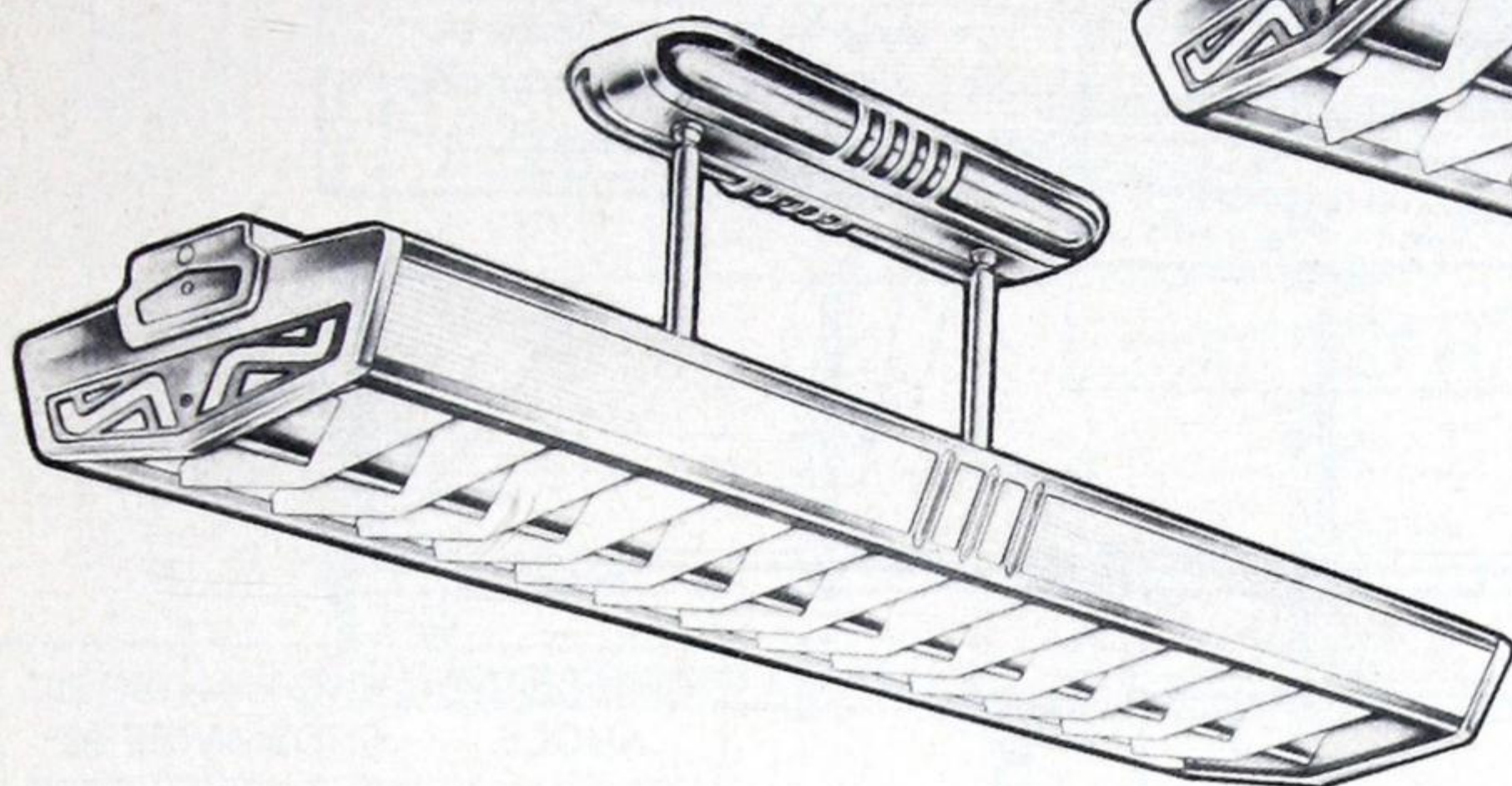
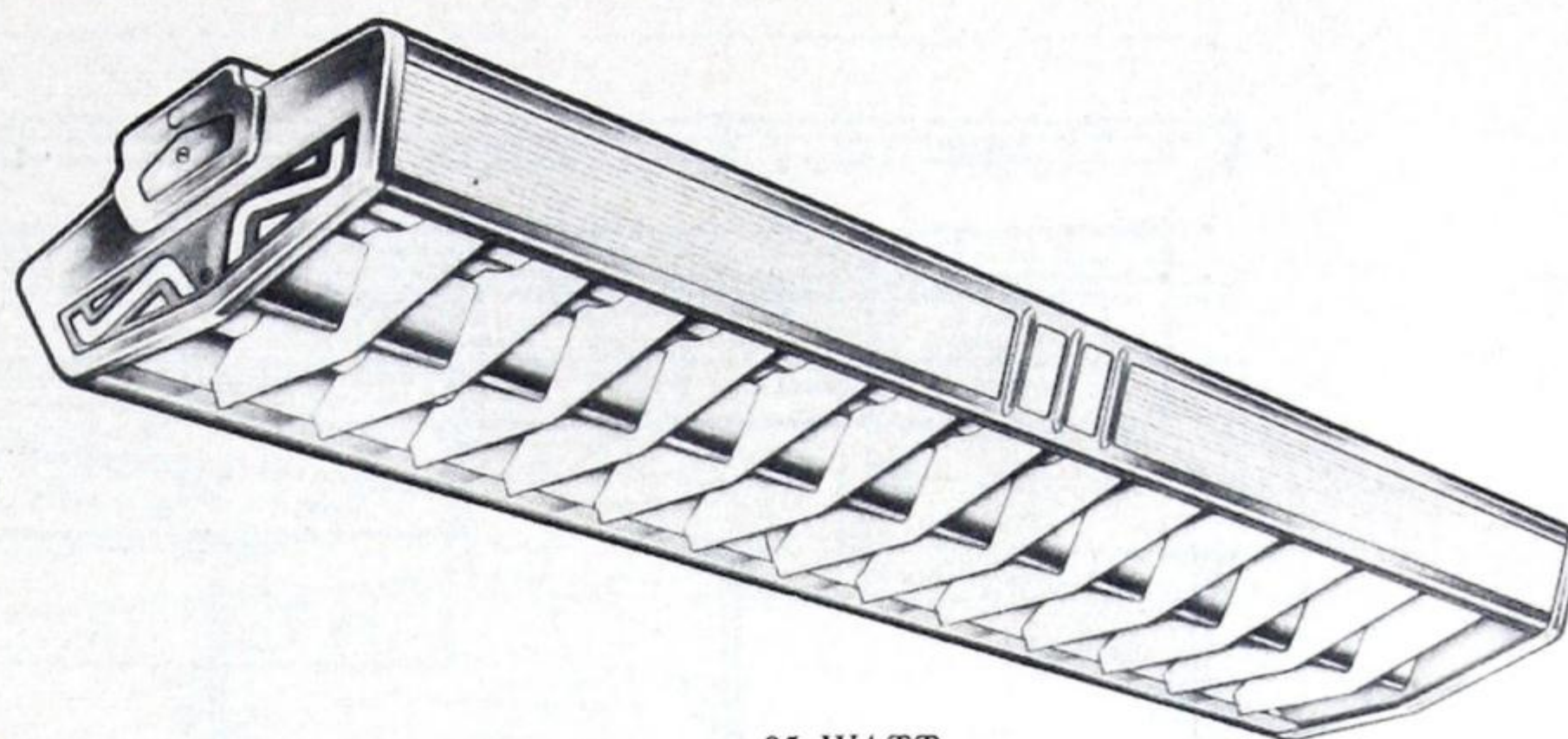
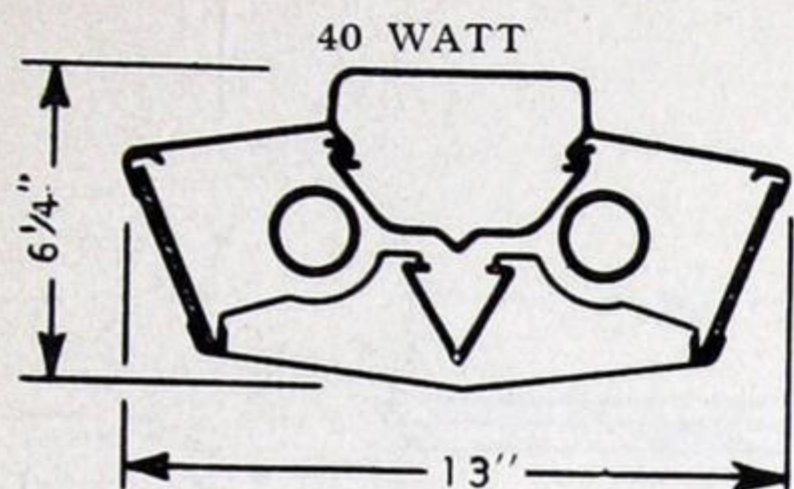

Complete units for two 40 watt or two 85 watt fluorescent lamps. These lighting units have many applications. They are efficient and easy to install and maintain. They are designed for both surface and suspension mounting.

CHASSIS—Die-formed and welded steel construction with snap-on wireway cover. Finish baked Super-White enamel.

MOUNTING—Chassis is arranged for either surface or suspension mounting. The chassis is provided with all necessary holes and knockouts for quick fastening to ceiling or for suspension mounting and for wire connections.

"VIZ-AID" ENCLOSURES—Steel frame of die-formed and welded construction. Lateral louvers finished in baked Super-White enamel, the V-shaped centre louver also in white enamel is designed to provide additional light output in the useful area of illumination. The side panels are of ribbed diffuse glass. Enclosure finished in baked Super-White or Metallic Grey enamel.

SERVICING THE "VIZ-AID" UNIT—The snap-on enclosure is supported to the chassis by spring tension clips and is easily lowered without the use of tools. Service chains support the enclosure when it is released from the chassis for cleaning. These chains can be unhooked from the chassis for complete removal of the enclosure if desired. Units can be relamped without disturbing the enclosure.

END PLATES—The decorative end plates are of die-formed steel and are finished in baked Metallic Grey, or baked Super-White enamel with the all white "VIZ-AID". They are attached to the chassis by a single screw and do not have to be removed for relamping.

WIRING—All units are furnished wired and supplied with best quality fully compensated standard 2 x 40 watt, or 2 x 85 watt ballasts, ensuring efficient starting and maximum lamp life and light output. They are equipped with standard type lamp and starter sockets, and standard starters. Automatic or manual reset starters will be supplied if specified.

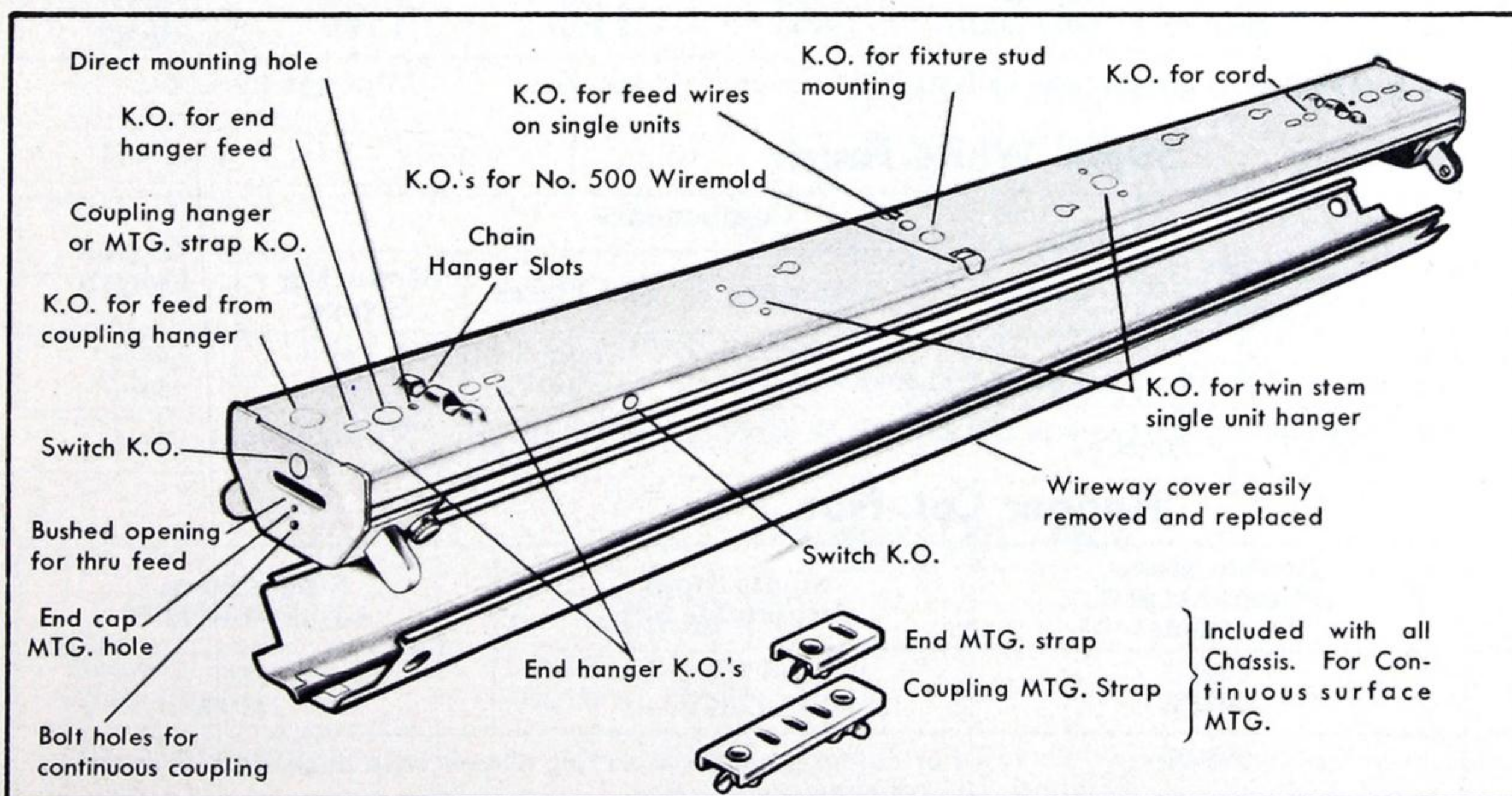

BASIC CHASSIS

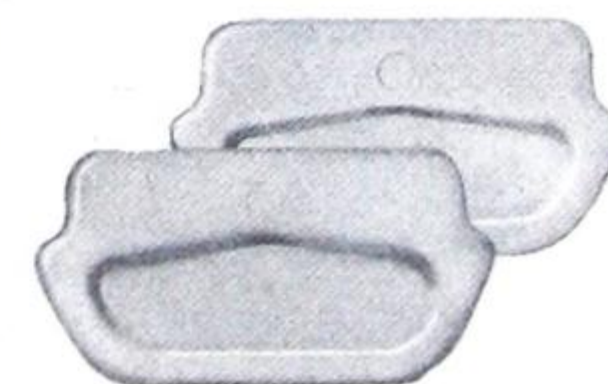
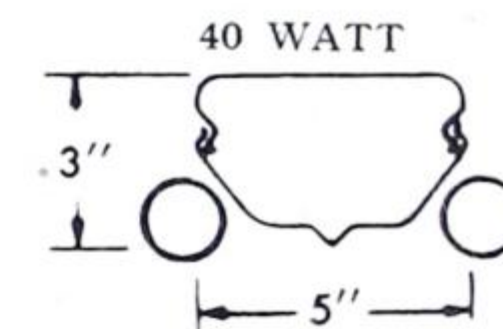

DECORATIVE END PLATES

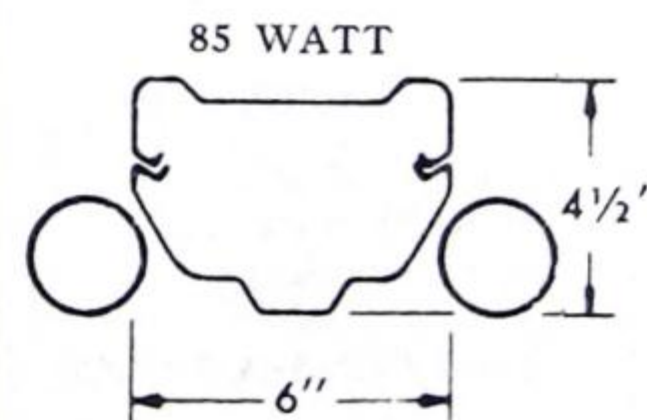

Included with all Chassis. For Continuous surface MTG.



FLUORESCENT SHIELDED UNITS

Day-Brite "Viz-Aid-2" Units (2 x 40W)

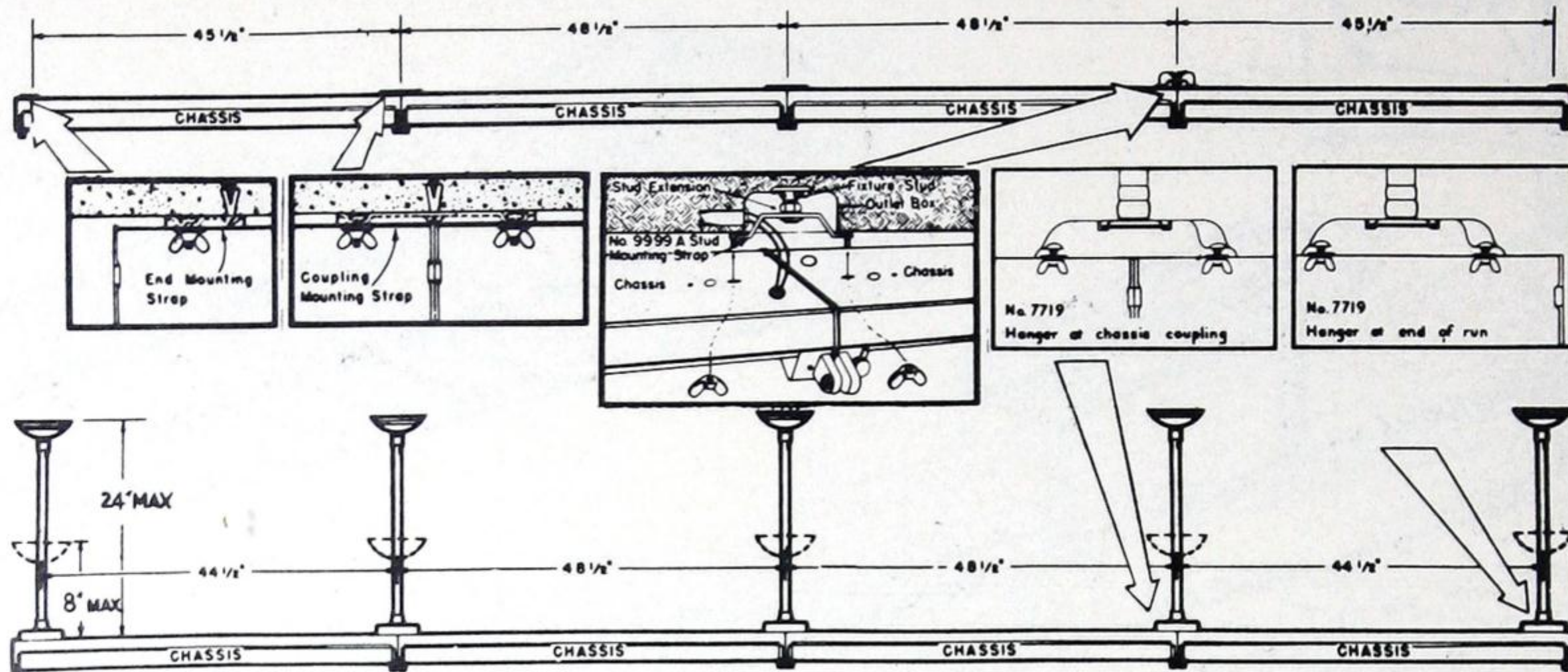

SHIELDING LENGTHWISE 28°
ANGLE CROSSWISE 37°

SPACING 1.0xMH		EFF 64.0%				
M.F.	"VIZ-AID-2" SURFACE	12.8%				
G.75		51.2%				
M.70						
P.65						
CEILING	75%	50%				
WALLS	50% 30% 10%	50% 30% 10%				
ROOM INDEX	COEFFICIENT OF UTILISATION					
J	.28	.25	.23	.27	.24	.23
I	.34	.31	.30	.32	.30	.29
H	.37	.34	.33	.35	.33	.32
G	.40	.38	.36	.38	.35	.34
F	.42	.40	.37	.39	.38	.36
E	.45	.43	.41	.43	.41	.39
D	.48	.45	.43	.45	.43	.41
C	.50	.47	.45	.47	.44	.43
B	.52	.49	.47	.48	.46	.45
A	.53	.51	.49	.49	.47	.46

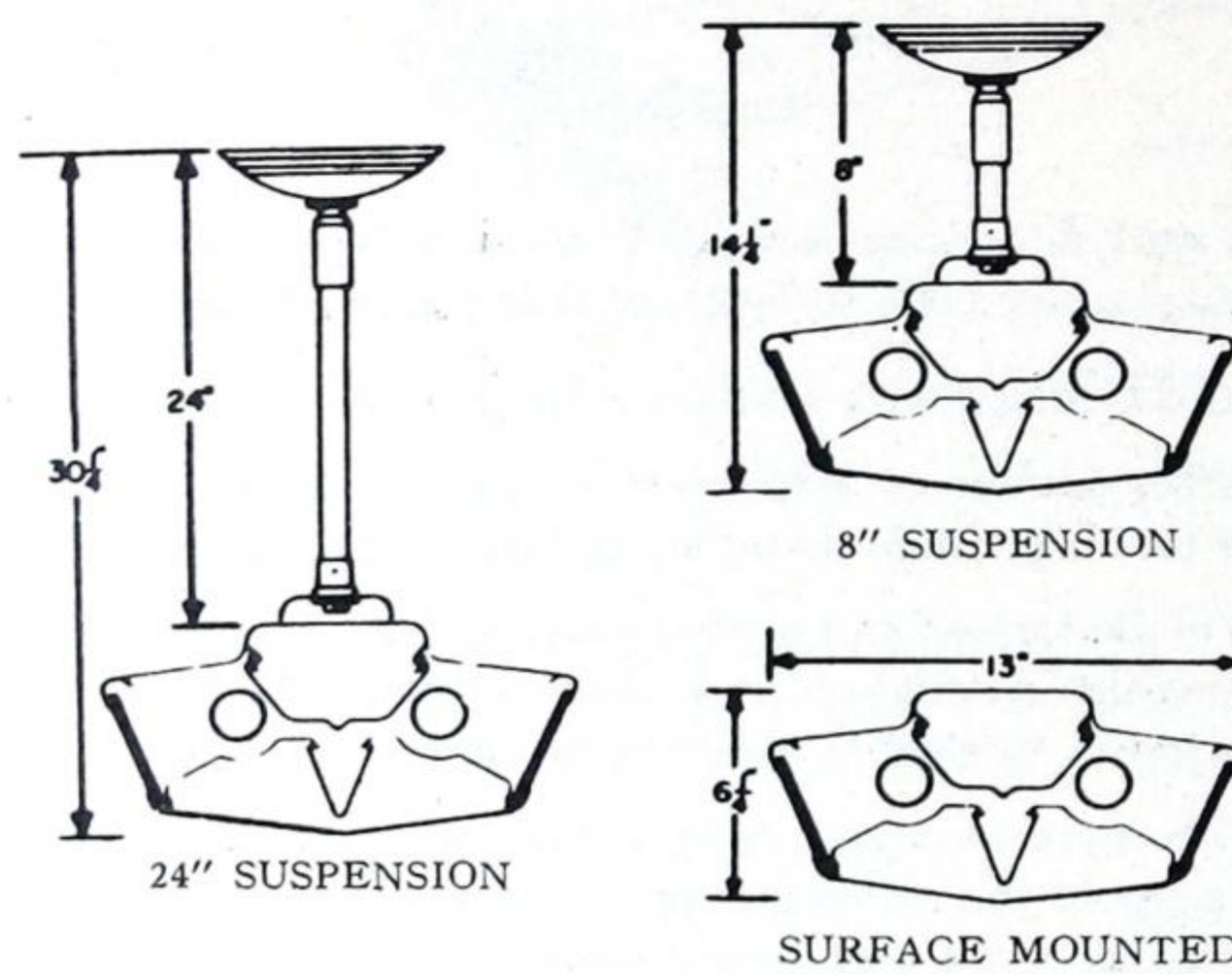

SHIELDING LENGTHWISE 28°
ANGLE CROSSWISE 37°

SPACING 1.25xMH		EFF 74.5%		
M.F.	"VIZ-AID-2" SUSPENSION	34.5%		
G.75		40.0%		
M.70				
P.65				
CEILING	75%	50%		
WALLS	50% 30% 10%	50% 30% 10%		
ROOM INDEX	COEFFICIENT OF UTILISATION			
J	.27	.26	.22	.21
I	.33	.30	.28	.27
H	.36	.34	.32	.30
G	.40	.37	.35	.33
F	.43	.39	.37	.35
E	.44	.43	.41	.38
D	.49	.46	.43	.41
C	.51	.48	.45	.42
B	.54	.51	.49	.45
A	.55	.53	.51	.48

Metallic Grey Finish

Catalogue No.	Lamps	Cycles	Components				Overall Length
			Chassis	Enclosure	End Plates	Mounting Straps	
46202-60*	2 x 40W	60	9987-60	9996	1 Pair	1 Pair	48 1/2"
46202-60-IS**	2 x 40W	60	9987-60-IS	9996	1 Pair	1 Pair	48 1/2"

*For 25 cycle operation, units with dual frequency 25/60 cycle ballasts will be supplied if specified.

**Instant start.

Super-White Finish

Catalogue No.	Lamps	Cycles	Components				Overall Length
			Chassis	Enclosure	End Plates	Mounting Straps	
46202-60W*	2 x 40W	60	9987-60	9996W	1 Pair	1 Pair	48 1/2"
46202-60-ISW**	2 x 40W	60	9987-60-IS	9996W	1 Pair	1 Pair	48 1/2"

*For 25 cycle operation, units with dual frequency 25/60 cycle ballasts will be supplied if specified.

**Instant start.

Hanger Cat. Nos.

Description	Double Stem Adjustable 24" Standard †*	Single Stem Adjustable 8" **	Single Stem Adjustable 24" **
Metallic Grey White Enamel	9925 9925W	7789 7789W	7719 7719W
Stud mounting strap	9999A	For mounting and connecting chassis with outlet box at chassis coupling.	

*Special length hangers will be supplied if specified.

†If used with dual frequency units specify with No. 9925A adapter.



FLUORESCENT SHIELDED UNITS

Day-Brite "Viz-Aid-2" Units (2 x 85W)

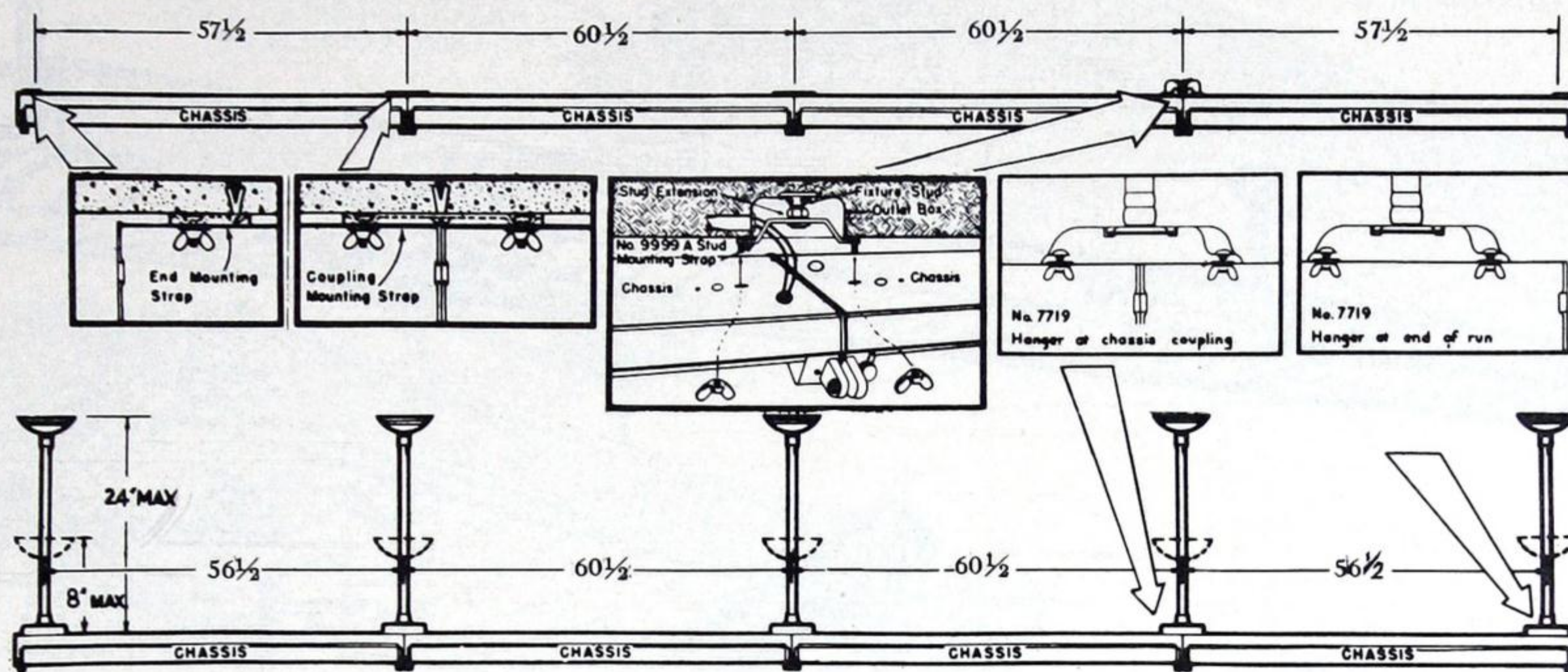

SHIELDING LENGTHWISE 26° ANGLE CROSSWISE 35°		SPACING 1xMH		EFF 55%		
M.F.	"VIZ-AID-2" SURFACE			11% ↑		
G.75				44% ↓		
M.70						
P.65						
CEILING	75%		50%			
WALLS	50%	30%	10%	50%	30%	10%
ROOM INDEX	COEFFICIENT OF UTILISATION					
J	.24	.22	.20	.23	.21	.20
I	.30	.27	.26	.28	.26	.25
H	.32	.30	.29	.31	.29	.28
G	.35	.33	.32	.33	.31	.30
F	.37	.35	.33	.34	.33	.32
E	.39	.38	.36	.37	.36	.34
D	.42	.40	.38	.39	.38	.36
C	.43	.41	.39	.41	.39	.37
B	.45	.43	.41	.42	.40	.39
A	.46	.44	.42	.43	.41	.40

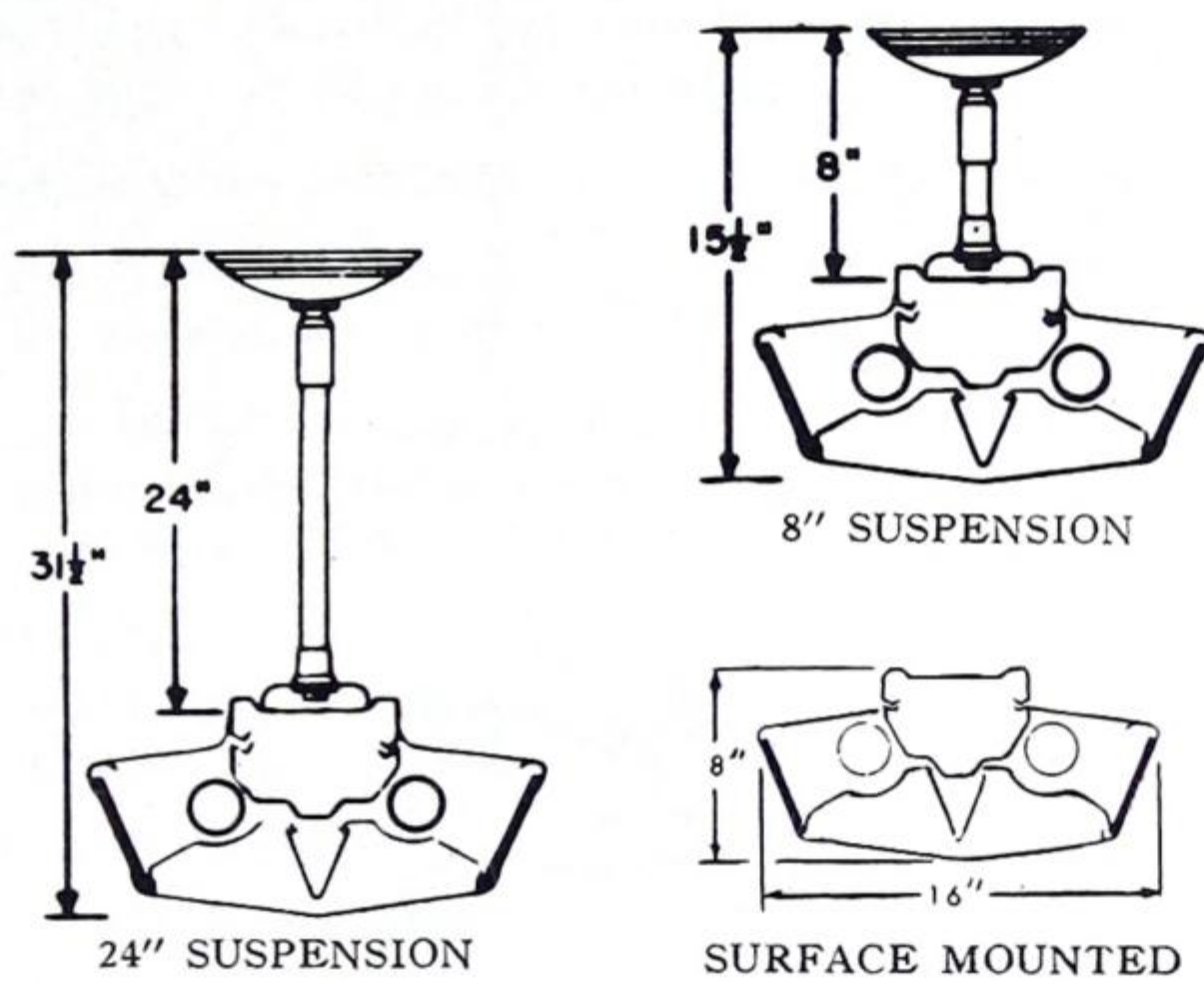

SHIELDING LENGTHWISE 26° ANGLE CROSSWISE 35°		SPACING 1.25xMH		EFF 72.8%		
M.F.	"VIZ-AID-2" SUSPENSION			36.2% ↑		
G.75				36.6% ↓		
M.70						
P.65						
CEILING	75%		50%			
WALLS	50%	30%	10%	50%	30%	10%
ROOM INDEX	COEFFICIENT OF UTILISATION					
J	.26	.23	.21	.24	.21	.18
I	.30	.28	.27	.28	.26	.24
H	.35	.32	.30	.31	.29	.28
G	.38	.35	.33	.34	.31	.30
F	.41	.38	.35	.36	.33	.32
E	.44	.41	.39	.40	.37	.35
D	.47	.44	.41	.41	.39	.37
C	.49	.46	.43	.42	.40	.39
B	.51	.48	.46	.44	.43	.41
A	.52	.50	.48	.46	.44	.42

Metallic Grey Finish

Catalogue No.	Lamps	Cycles	Components				Overall Length
			Chassis	Enclosure	End Plates	Mounting Straps	
55202-60	2 x 85W	60	7787-60	7796	1 Pair	1 Pair	61"

Super-White Finish

Catalogue No.	Lamps	Cycles	Components				Overall Length
			Chassis	Enclosure	End Plates	Mounting Straps	
55202-60W	2 x 85W	60	7787-60	7796W	1 Pair	1 Pair	61"

Hanger Cat. Nos.

Description	Double Stem Adjustable 24''*	Single Stem Adjustable 8''*	Single Stem Adjustable 24''*
Metallic Grey White Enamel	9925 and 9925A adapter 9925W and 9925A adapter	7789 7789W	7719 7719W
Stud Mounting Strap	9999A	For mounting and connecting chassis with outlet box at chassis coupling.	

*Special length hangers will be supplied if specified.



FLUORESCENT SHIELDED UNITS

Day-Brite "Viz-Aid-2" Units

Hangers

"VIZ-AID-2"—CONTINUOUS ROW

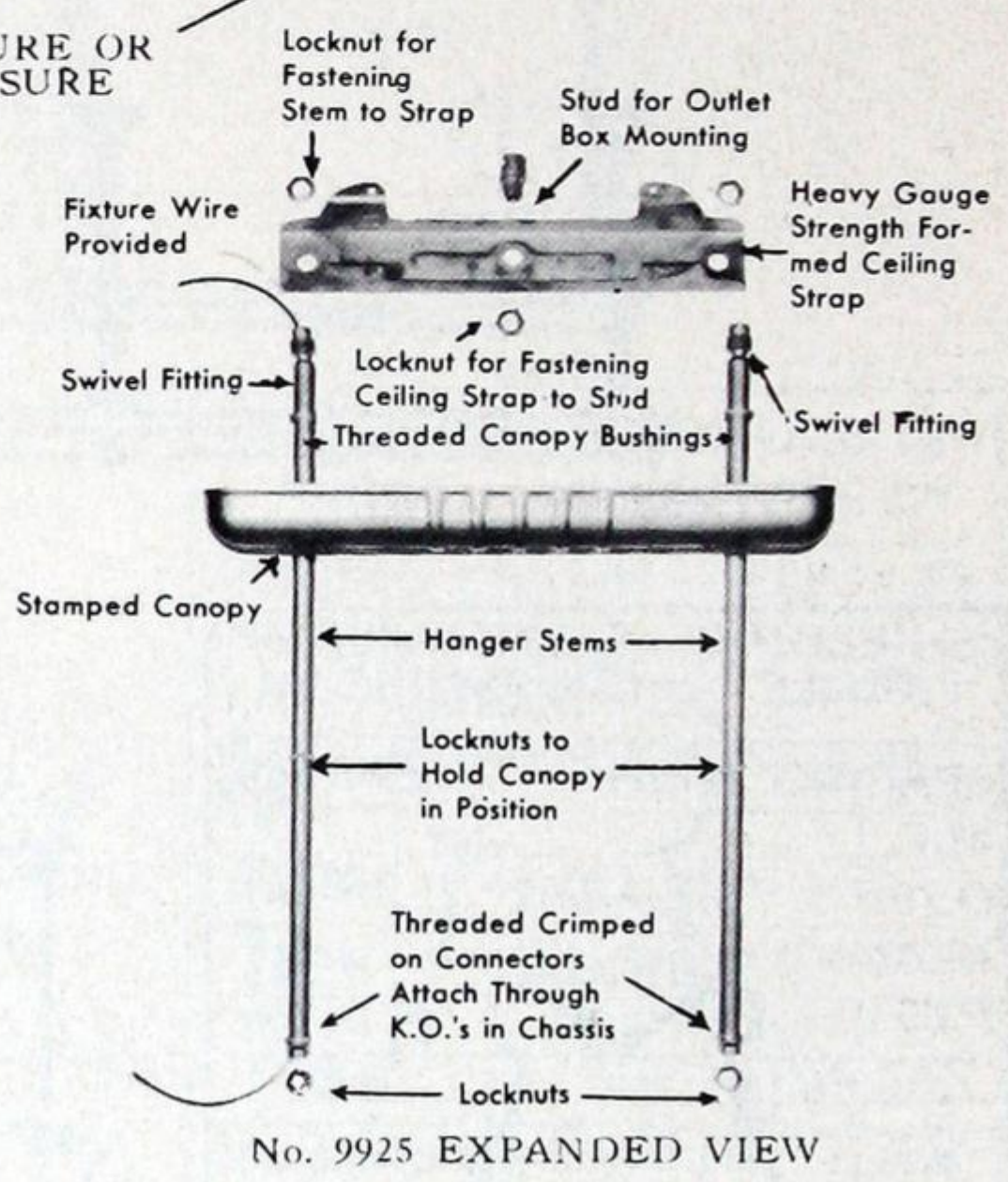
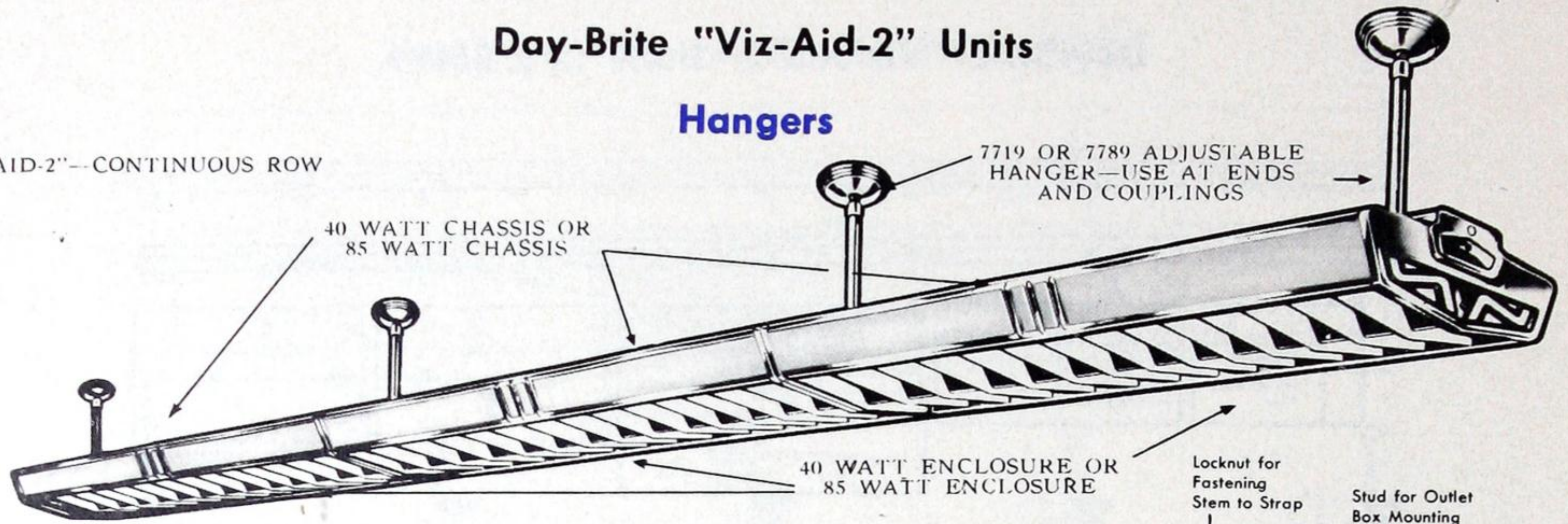

No. 9925 EXPANDED VIEW



No. 7789—8"



No. 7719—24"

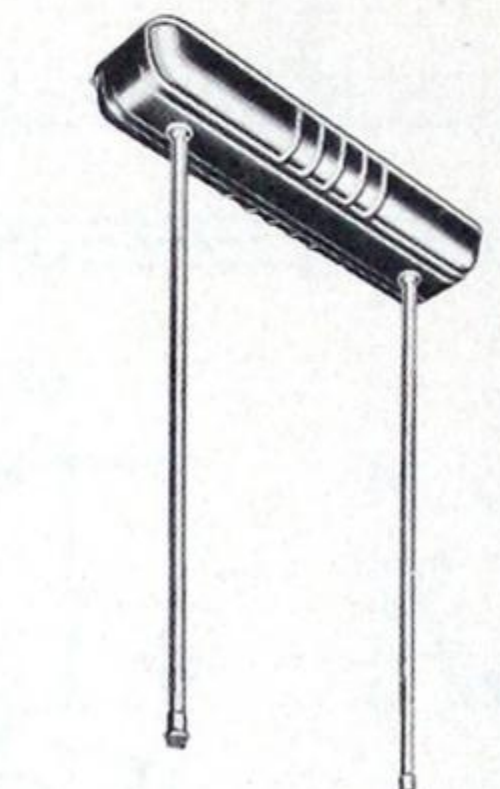

DOUBLE STEM 24" HANGER—STANDARD No. 9925



No. 9999-A—STUD MOUNTING STRAP For mounting and connecting chassis with outlet box at chassis coupling.

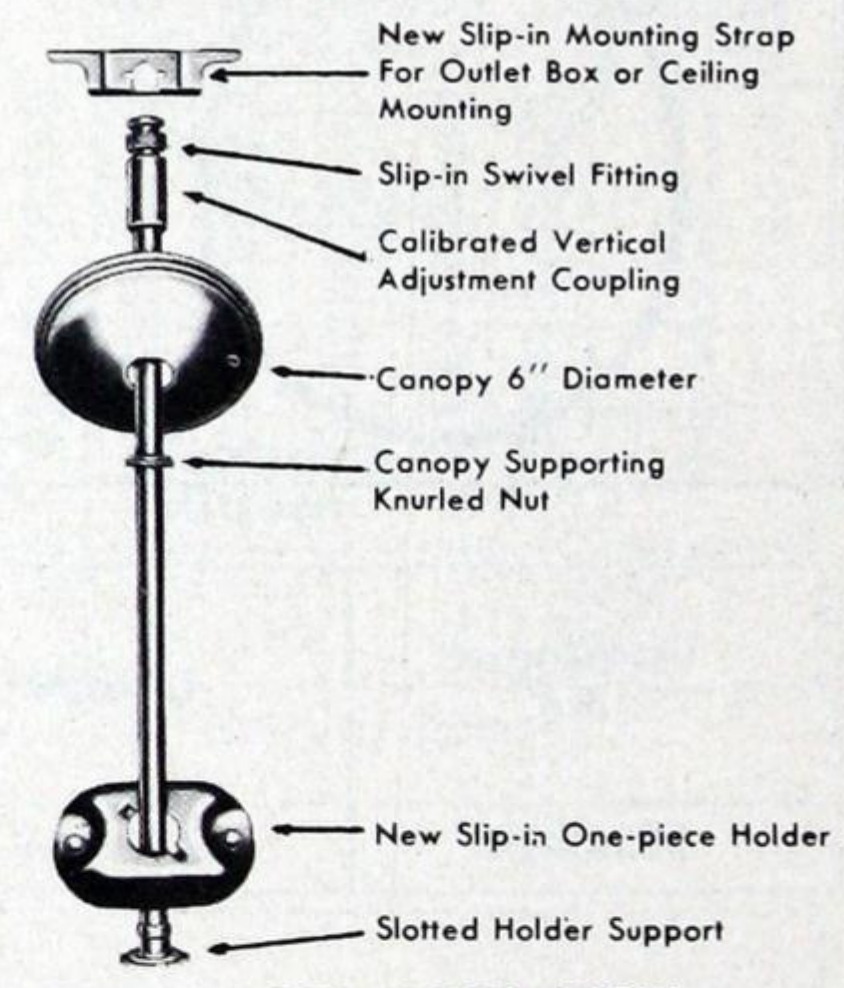

No. 7789, 7719 EXPANDED VIEW

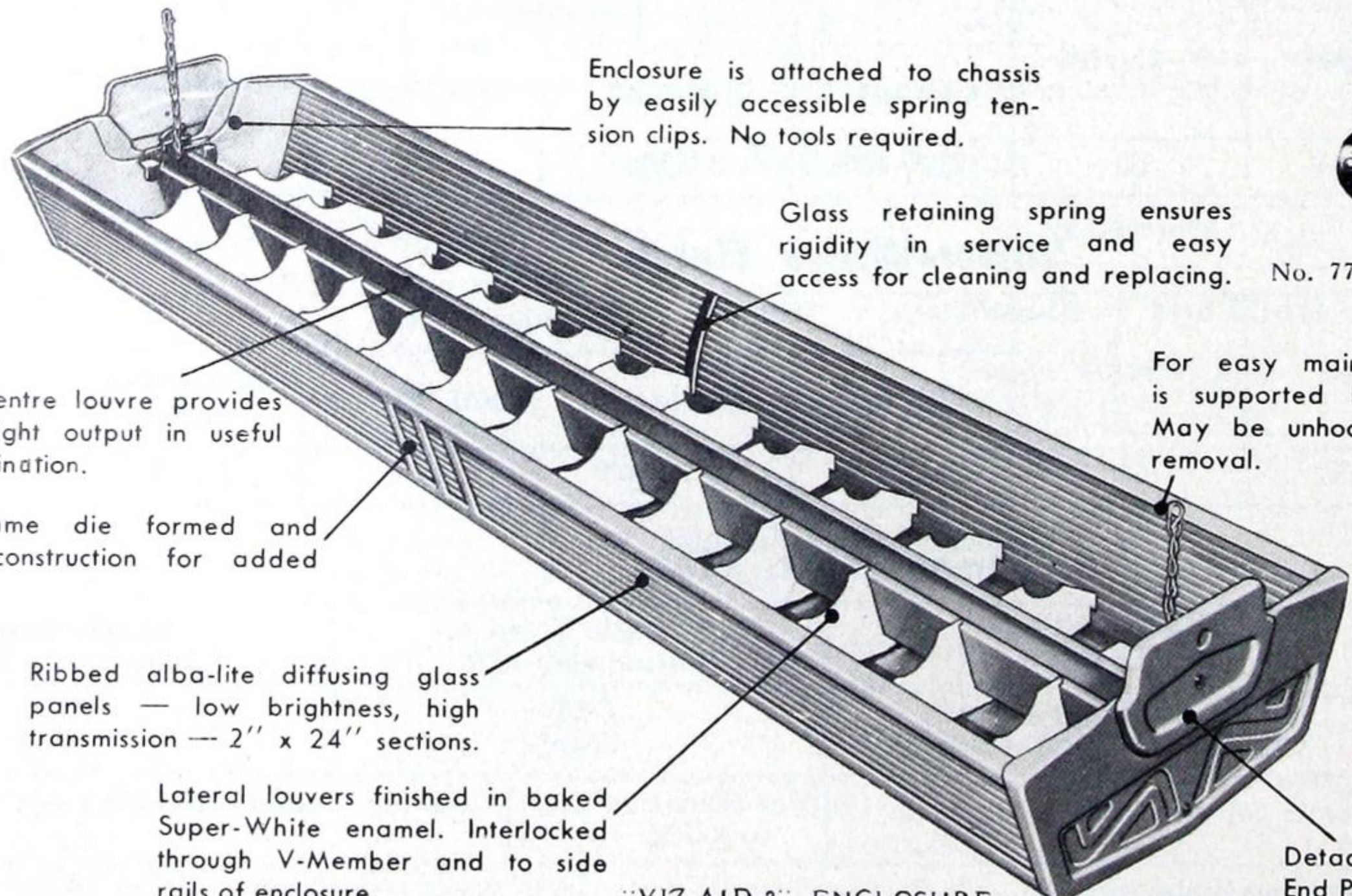

"VIZ AID 2" ENCLOSURE

For easy maintenance enclosure is supported by service chains. May be unhooked for complete removal.



FLUORESCENT SHIELDED UNITS

Day-Brite "Viz-Aid-4" Units

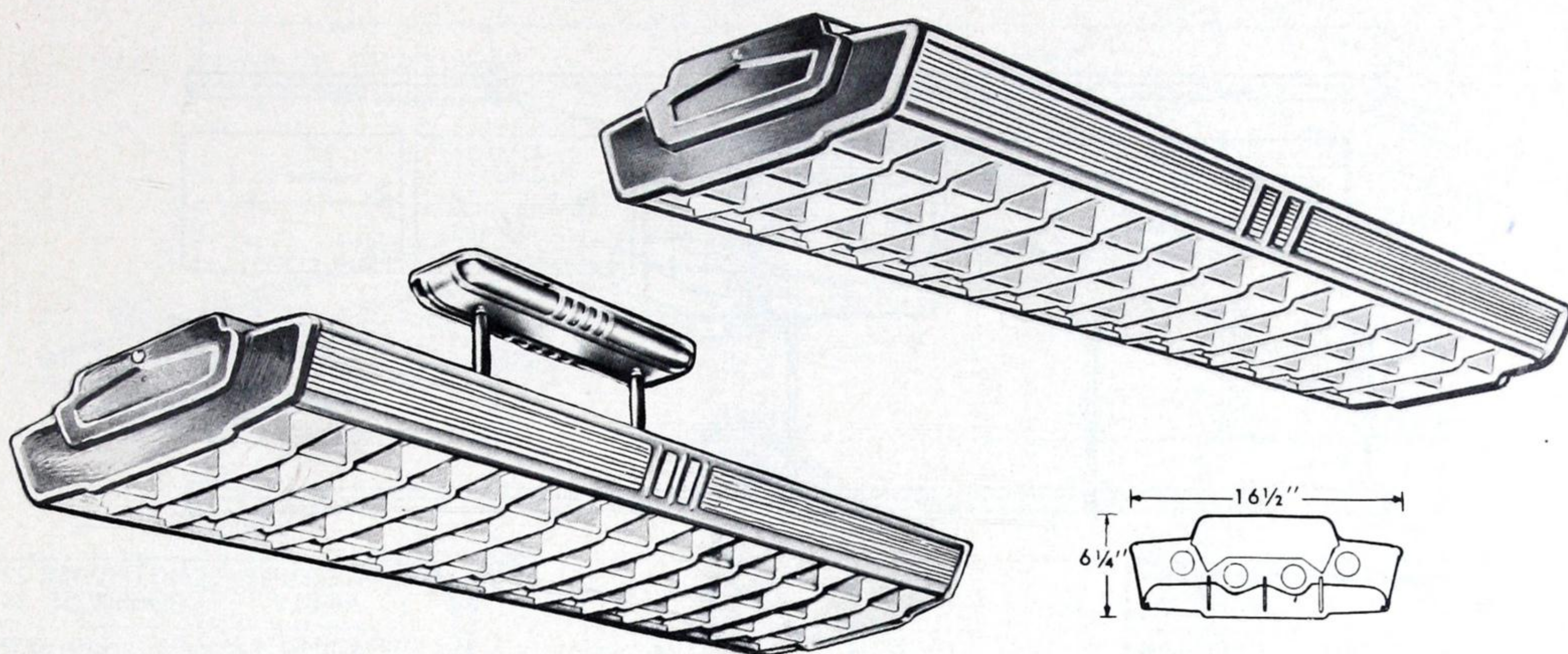

Complete units for four 40 watt fluorescent lamps. These lighting units have many applications. They are efficient and easy to instal and maintain. They are designed for both surface and suspension mounting.

CHASSIS—Die-formed and welded steel construction with snap-on wireway cover. Finish baked Super-White enamel.

MOUNTING—Chassis is arranged for either surface or suspension mounting. The chassis is provided with all necessary holes and knockouts for quick fastening to ceiling or for suspension mounting and for wire connections.

"VIZ-AID" ENCLOSURES—Steel frame of die-formed and welded construction. Lateral Louvers finished in baked Super-White enamel, the V-shaped centre louver also in white enamel is designed to provide additional light output in the useful area of illumination. The side panels are of ribbed diffuse glass. Enclosure finished in baked Super White enamel or baked Metallic Grey.

SERVICING THE "VIZ-AID" UNIT—The snap-on enclosure is supported to the chassis by spring tension clips and is easily lowered without the use of tools. Service chains support the enclosure when it is released from the chassis for cleaning. These chains can be unhooked from the chassis for complete removal of the enclosure if desired. Units can be relamped without disturbing the enclosure.

END PLATES—The decorative end plates are of die-formed steel and are finished in baked Metallic Grey, or baked Super-White enamel with the all white "VIZ-AID". They are attached to the chassis by a single screw and do not have to be removed for relamping.

WIRING—All units are furnished wired and supplied with best quality fully compensated standard 2 x 40 watt ballasts, ensuring efficient starting and maximum lamp life and light output. They are equipped with standard type lamp and starter sockets, and standard starters. Automatic or manual reset starters will be supplied if specified.

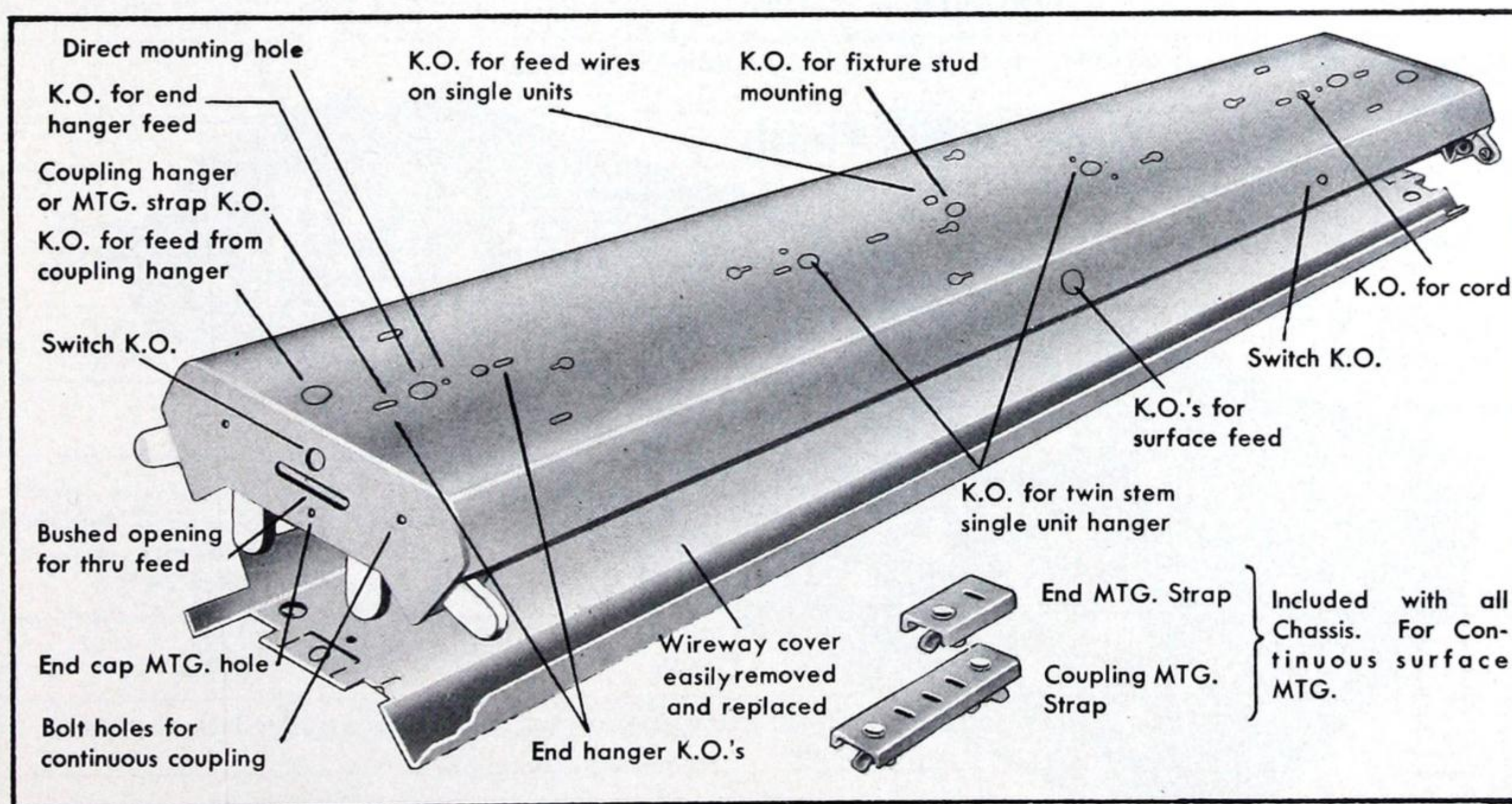

BASIC CHASSIS

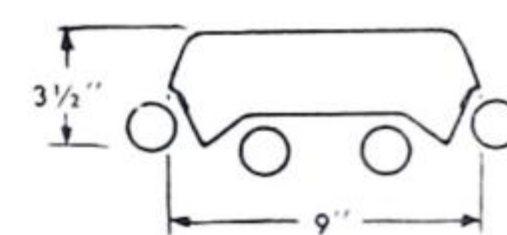

DECORATIVE END PLATES



FLUORESCENT SHIELDED UNITS

Day-Brite "Viz-Aid-4" Units

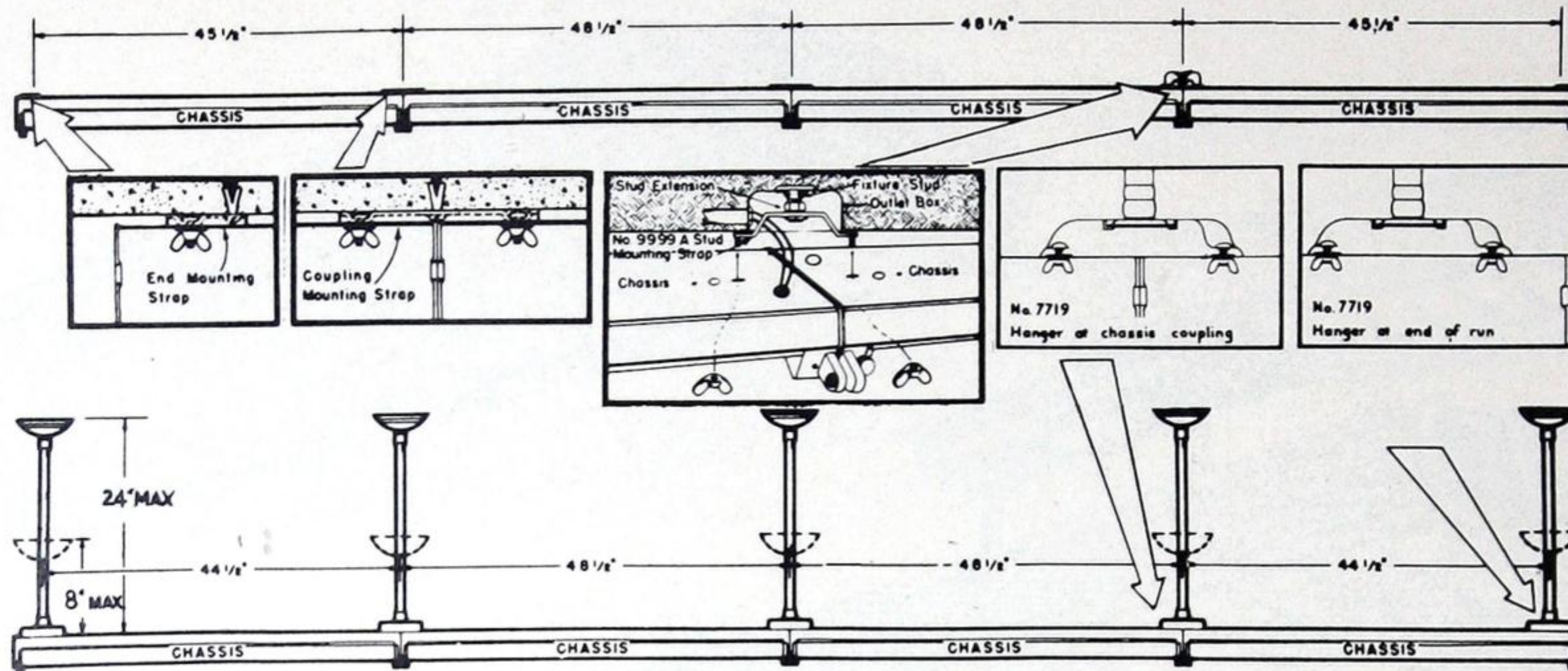

SHIELDING LENGTHWISE 22° ANGLE CROSSWISE 38°	
SPACING 1.0xMH	EFF 59.0%
M.F.	
G.75	"VIZ-AID-4" 7.08%
M.70	SURFACE 51.92%
P.65	
CEILING	75% 50%
WALLS	50% 30% 10% 50% 30% 10%
ROOM INDEX	COEFFICIENT OF UTILISATION
J	.28 .25 .24 .27 .25 .24
I	.33 .32 .31 .33 .31 .30
H	.37 .35 .34 .36 .34 .33
G	.40 .38 .37 .38 .37 .35
F	.42 .40 .38 .40 .39 .37
E	.45 .43 .41 .43 .42 .40
D	.48 .45 .43 .46 .44 .42
C	.49 .47 .44 .47 .45 .44
B	.51 .49 .47 .49 .46 .45
A	.52 .50 .48 .49 .48 .46

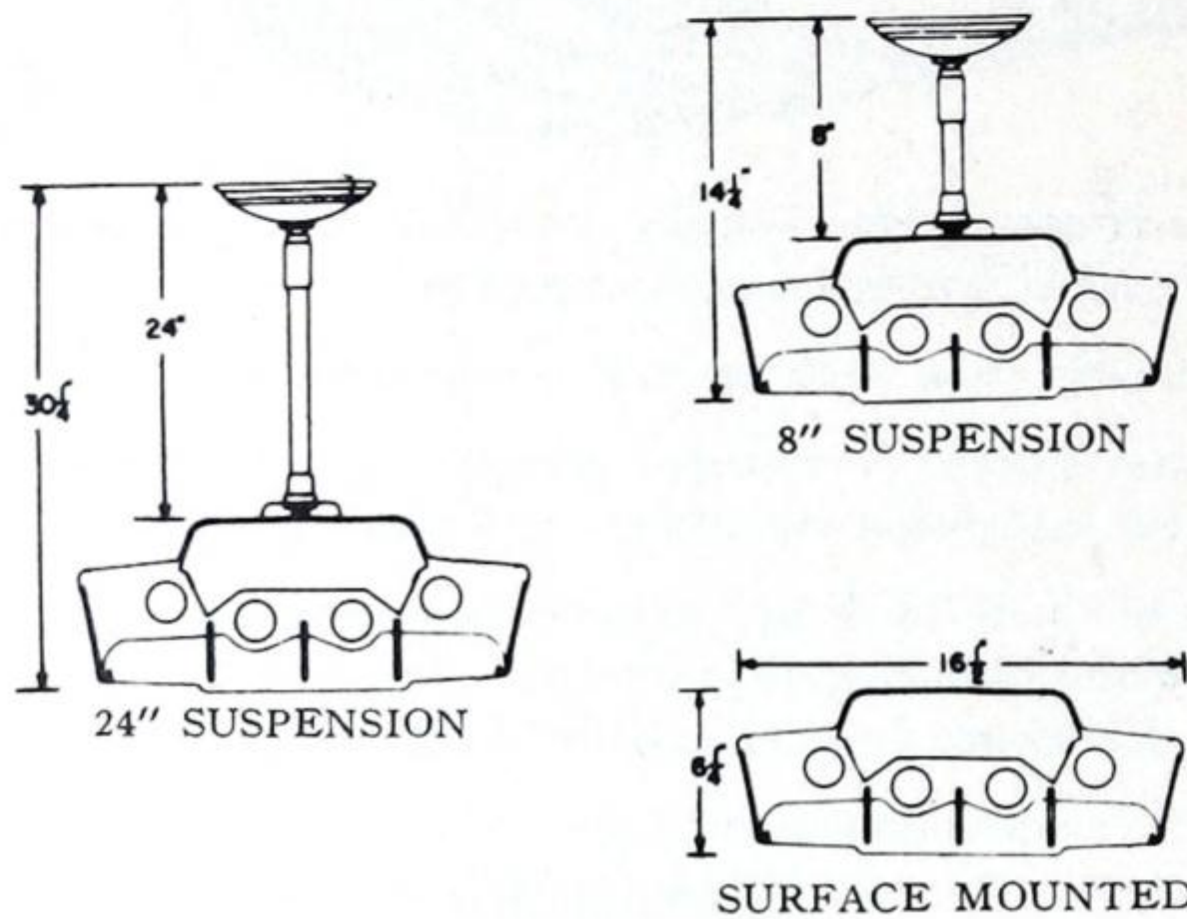

SHIELDING LENGTHWISE 22° ANGLE CROSSWISE 38°	
SPACING 1.25xMH	EFF 67.5%
M.F.	
G.75	"VIZ-AID-4" 20.25%
M.70	SUSPENSION 47.25%
P.65	
CEILING	75% 50%
WALLS	50% 30% 10% 50% 30% 10%
ROOM INDEX	COEFFICIENT OF UTILISATION
J	.29 .25 .23 .27 .24 .22
I	.35 .32 .31 .32 .30 .29
H	.38 .36 .35 .36 .34 .33
G	.42 .39 .39 .38 .37 .35
F	.44 .42 .39 .40 .39 .37
E	.47 .45 .43 .44 .42 .40
D	.50 .48 .45 .46 .44 .43
C	.52 .50 .47 .48 .46 .44
B	.54 .51 .50 .49 .47 .46
A	.55 .53 .51 .50 .49 .47

Metallic Grey Finish

Catalogue No.	Lamps	Cycles	Components				Overall Length
			Chassis	Enclosure	End Plates	Mounting Straps	
46432-60*	4 x 40W	60	7790-60	7694	1 Pair	1 Pair	49 1/4"
46432-60-IS**	4 x 40W	60	7790-60-IS	7694	1 Pair	1 Pair	49 1/4"

*For 25 cycle operation, units with dual frequency 25/60 cycle ballasts will be supplied if specified.
**Instant start.

Super-White Finish

Catalogue No.	Lamps	Cycles	Components				Overall Length
			Chassis	Enclosure	End Plates	Mounting Straps	
46432-60W*	4 x 40W	60	7790-60	7694W	1 Pair	1 Pair	49 1/4"
46432-60-ISW**	4 x 40W	60	7790-60	7694W	1 Pair	1 Pair	49 1/4"

*For 25 cycle operation, units with dual frequency 25/60 cycle ballasts will be supplied.
**Instant start.

Hanger Cat. Nos.

Description	Double Stem Adjustable 24" Standard†*	Single Stem Adjustable 8"***	Single Stem Adjustable 24"***
Metallic Grey	9925	7789	7719
White Enamel	9925W	7789W	7719W
Stud mounting strap	9999A	For mounting and connecting chassis with outlet box at chassis coupling.	

*Special length hangers will be supplied if specified.
†Where this hanger is to be used with dual frequency units specify with No. 9925A adapter.



FLUORESCENT SHIELDED UNITS

Day-Brite "Viz-Aid-4" Units

Hangers

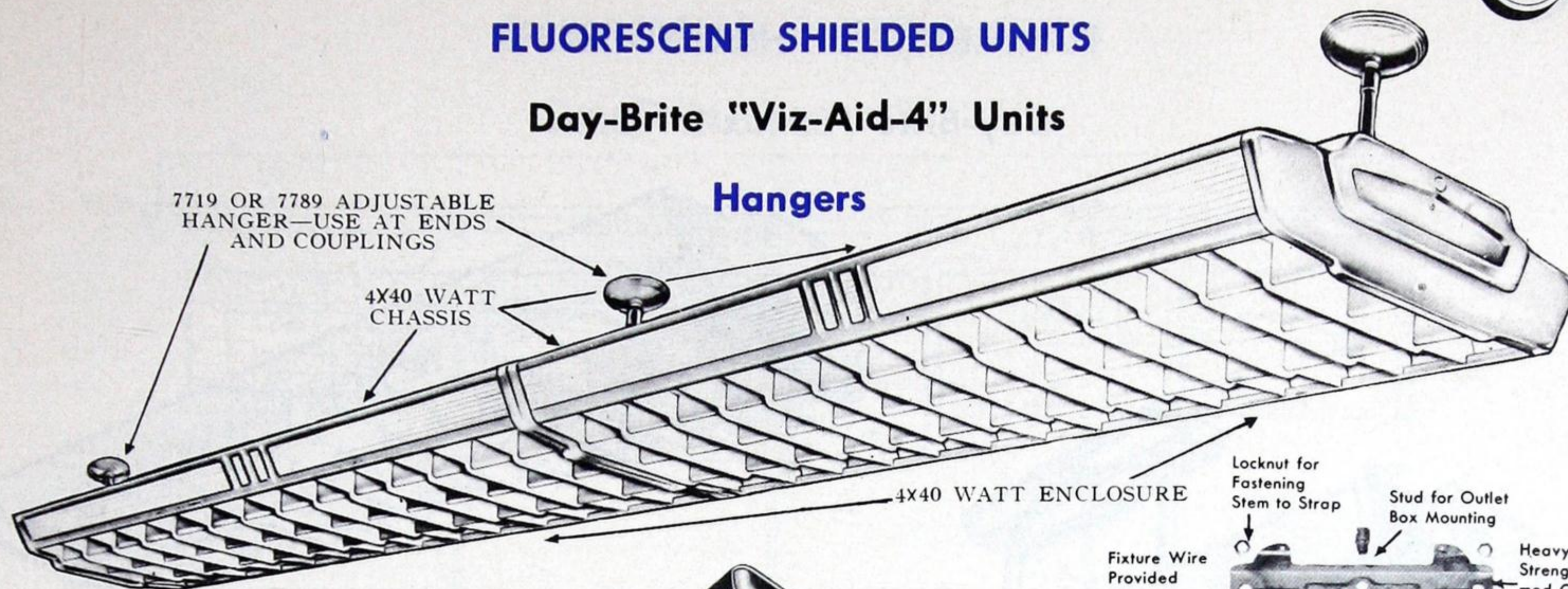

7719 OR 7789 ADJUSTABLE HANGER—USE AT ENDS AND COUPLINGS

4X40 WATT CHASSIS

4X40 WATT ENCLOSURE

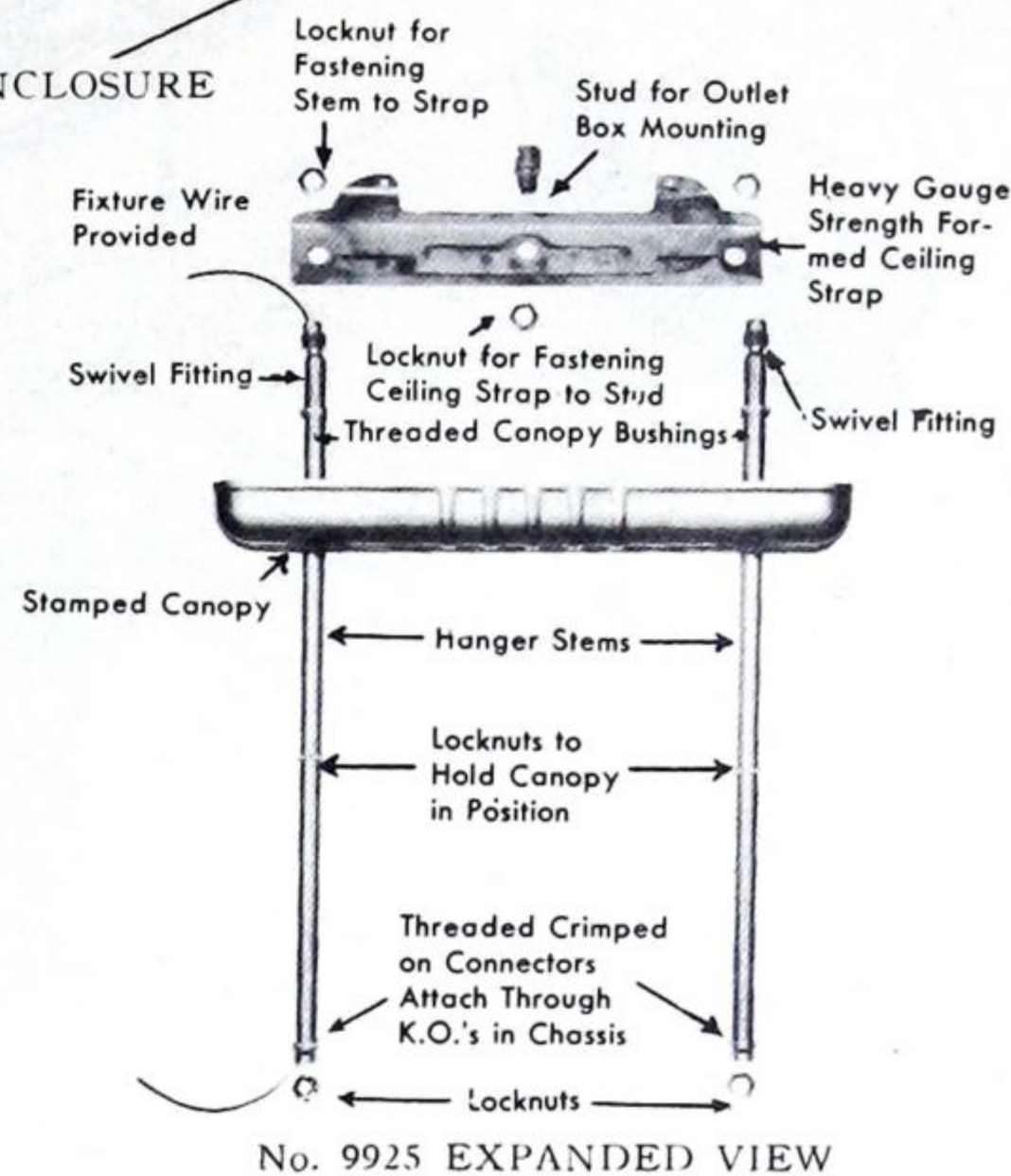

No. 9925 EXPANDED VIEW



No. 7789—8"

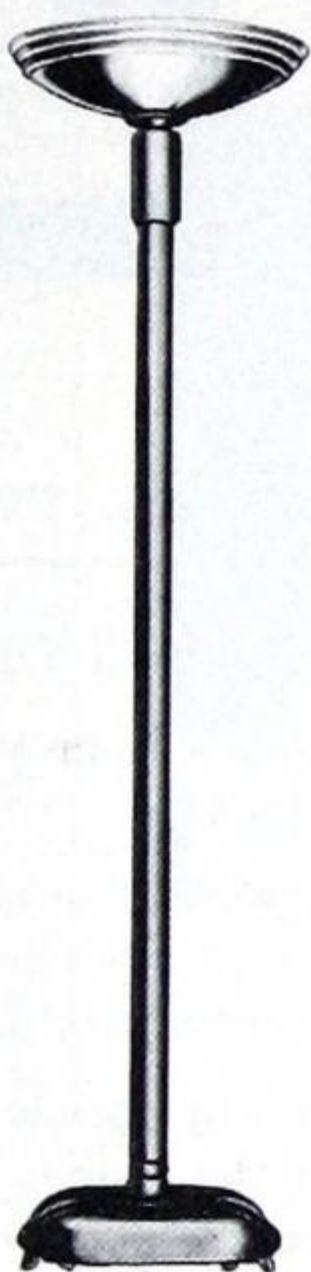

No. 7719—24"

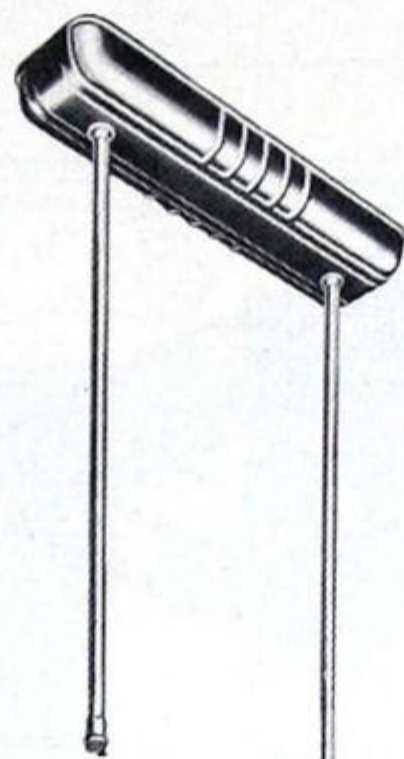

DOUBLE STEM 24" HANGER—STANDARD No. 9925



No. 9999-A—STUD MOUNTING STRAP For mounting and connecting chassis with outlet box at chassis coupling.

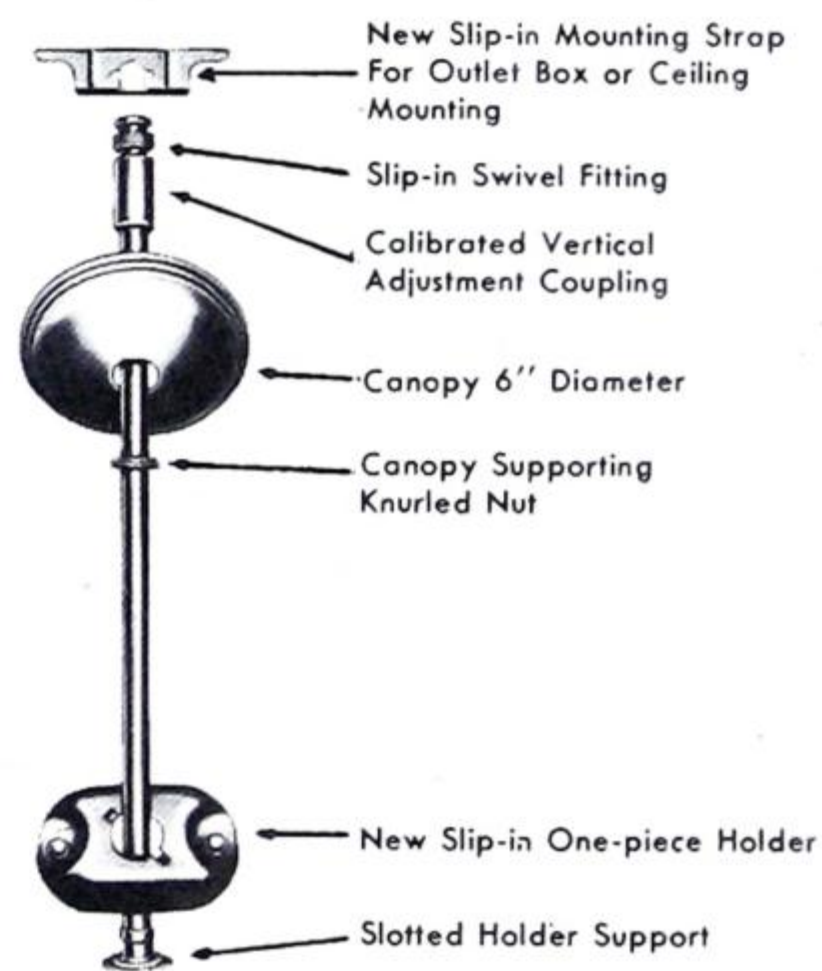

No. 7789, 7719 EXPANDED VIEW

Enclosure is attached to chassis by easily accessible spring tension clips. No tools required.

Glass retaining spring ensures rigidity in service and easy access for cleaning and replacing.

Inter-locking boxco louvers, double wall longitudinal members interlocked through lateral members to side rails of enclosure frame.

Steel frame die formed and welded construction, for added strength.

Ribbed alba-lite diffusing glass panels — low brightness, high transmission — 2" x 24" sections.

For easy maintenance enclosure is supported by service chains. May be unhooked for complete removal.

Detachable End Plates.

"VIZ-AID-4" ENCLOSURE



FLUORESCENT SHIELDED UNITS

Day-Brite "Lenox-2" Units

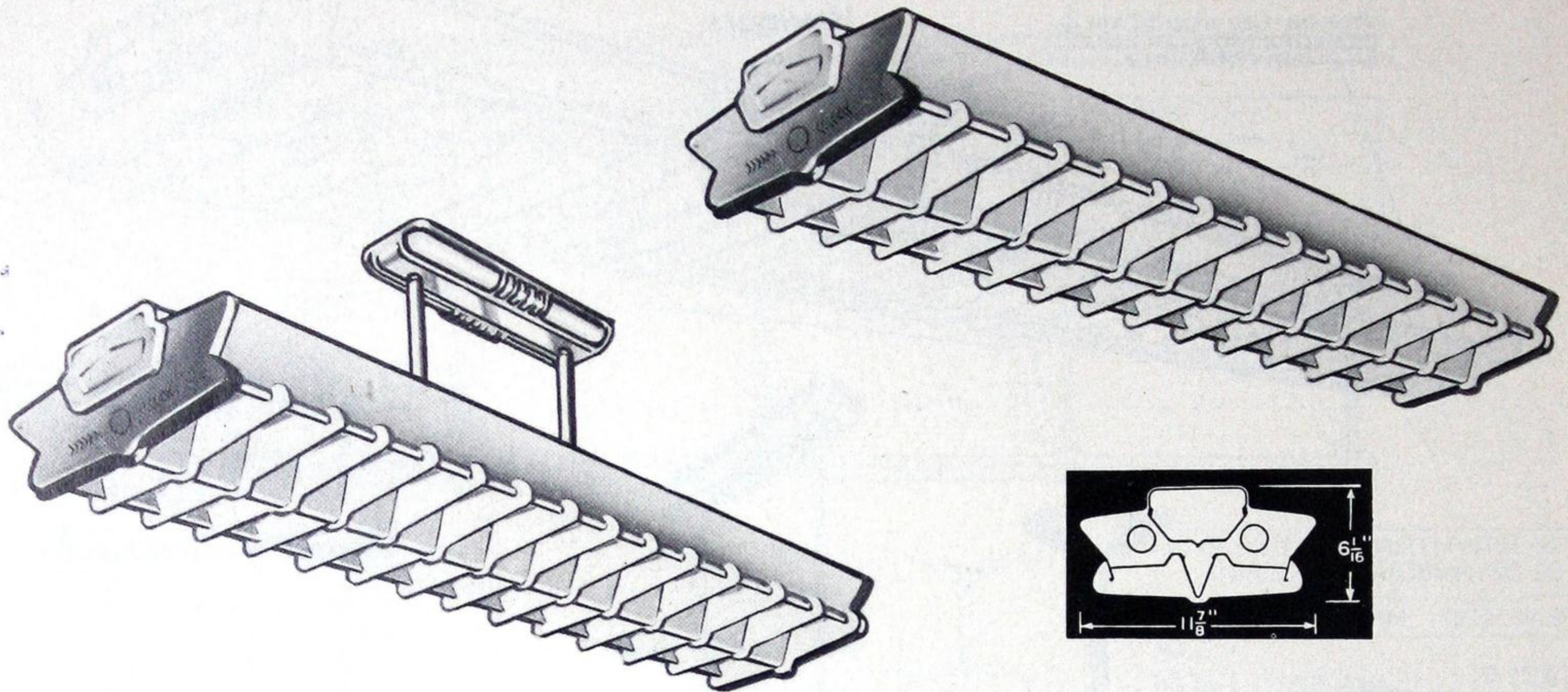

Complete units for two 40 watt fluorescent lamps. These lighting units have many applications. They are efficient and easy to install and maintain. They are designed for both surface and suspension mounting.

CHASSIS—Die-formed and welded steel construction with snap-on wireway cover. Finish baked Super-White enamel.

MOUNTING—Chassis is arranged for either surface or suspension mounting. The chassis is provided with all necessary holes and knockouts for quick fastening to ceiling or for suspension mounting and for wire connections.

"LENOX" ENCLOSURES—These are of an entirely new design supplied with all metal enclosing elements or with plastic side panels. The metal side panels and louver assembly are finished in baked Super White enamel with the ends in baked Metallic Grey enamel. The louver design is exclusively Day-Brite, engineered to provide the correct angle of shielding and low surface brightness.

SERVICING THE "LENOX" UNIT—The snap-on enclosure is supported to the chassis by spring tension clips and is easily lowered without the use of tools. Service chains support the enclosure when it is released from the chassis for cleaning. These chains can be unhooked from the chassis for complete removal of the enclosure if desired. Units can be relamped without disturbing the enclosure.

WIRING—All units are finished wired and supplied with best quality fully compensated standard 2 x 40 watt ballasts, ensuring efficient starting and maximum lamp life and light output. They are equipped with standard type lamp and starter sockets, and standard starters. Automatic or manual reset starters will be supplied if specified.

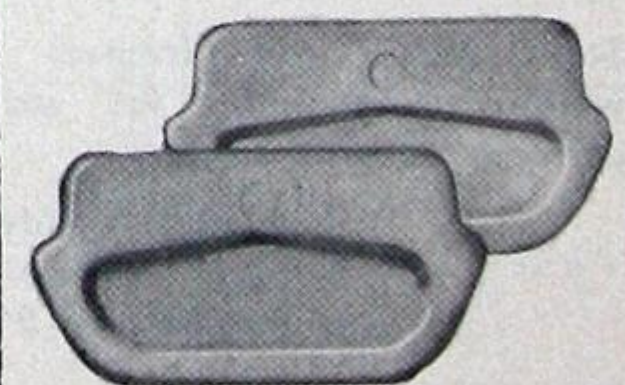
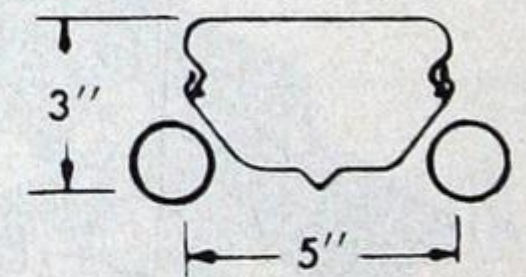
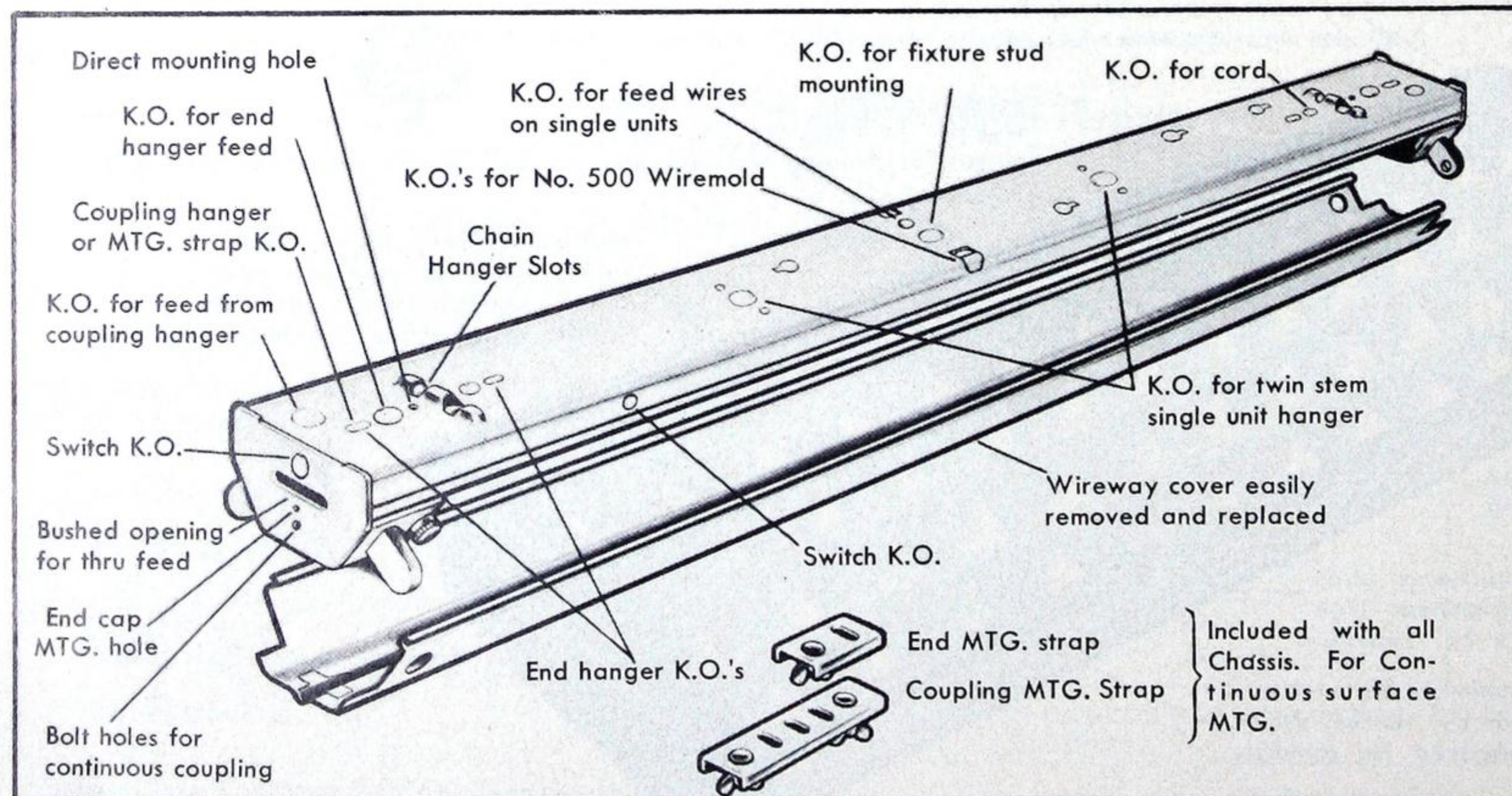

DECORATIVE END PLATES

BASIC CHASSIS



FLUORESCENT SHIELDED UNITS

Day-Brite "Lenox-2" Units

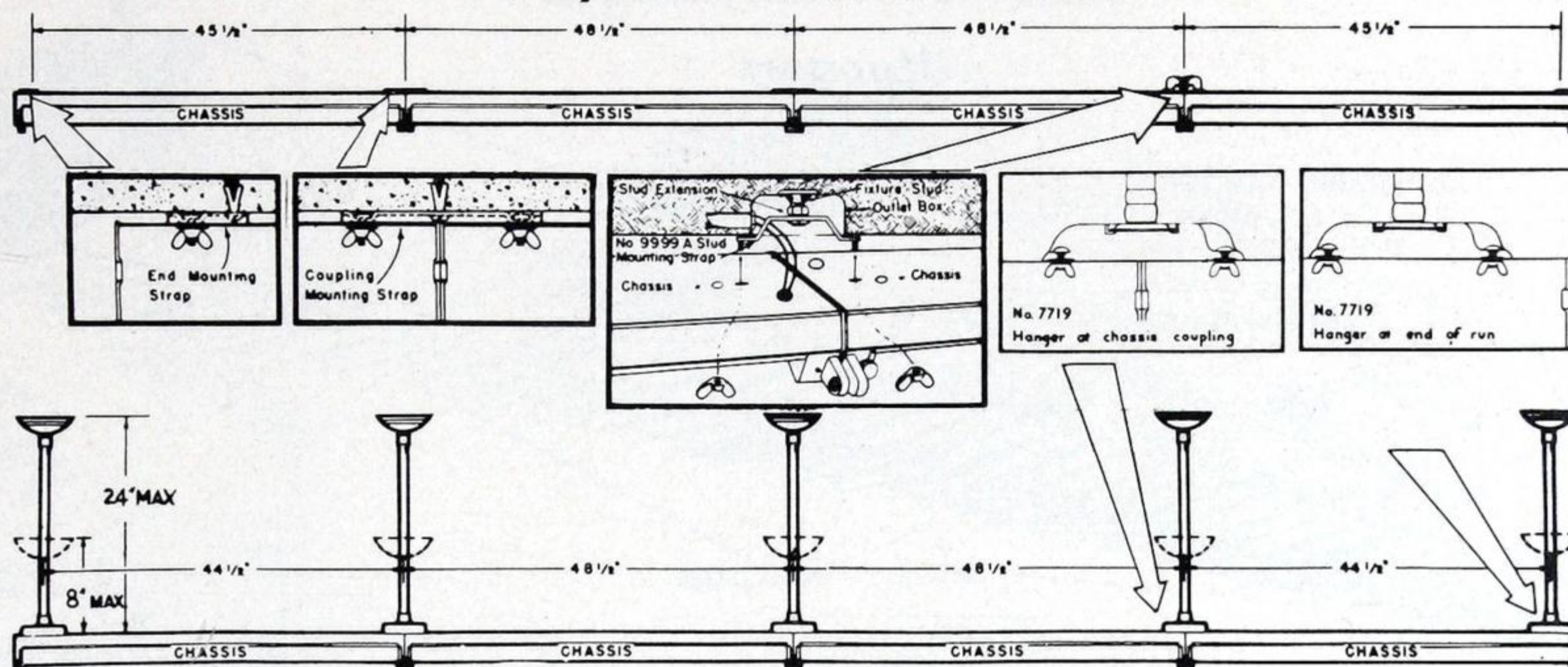

SHIELDING LENGTHWISE 25° ANGLE CROSSWISE 39°						
SPACING 1.25xMH EFF 63.0%						
M.F.	"LENOX-2" SURFACE PLASTIC SIDES					6.5%
G.70						56.5%
M.65						
P.60						
CEILING	75%		50%			
WALLS	50%	30%	10%	50%	30%	10%
ROOM INDEX	COEFFICIENT OF UTILISATION					
J	.29	.25	.24	.28	.25	.23
I	.35	.32	.27	.34	.31	.30
H	.38	.35	.34	.37	.34	.33
G	.41	.38	.37	.39	.37	.35
F	.43	.41	.39	.41	.39	.37
E	.46	.44	.42	.45	.43	.41
D	.50	.46	.44	.47	.45	.43
C	.51	.49	.45	.49	.47	.45
B	.53	.50	.48	.51	.48	.47
A	.54	.52	.50	.52	.50	.48

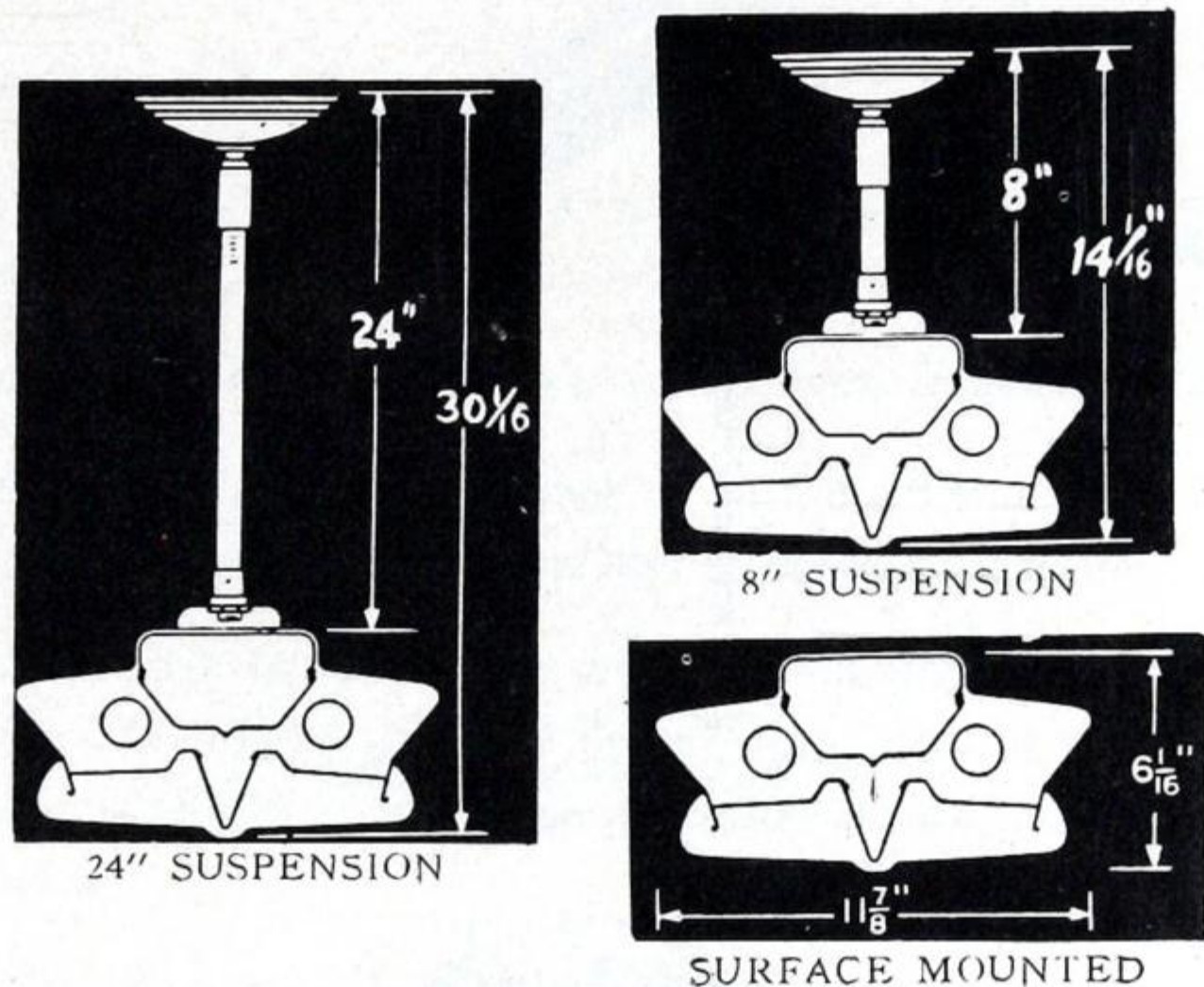

SHIELDING LENGTHWISE 25° ANGLE CROSSWISE 39°						
SPACING 1.25xMH EFF 83%						
M.F.	"LENOX-2" SUSPENSION PLASTIC SIDES					37.5%
G.70						45.5%
M.65						
P.60						
CEILING	75%		50%			
WALLS	50%	30%	10%	50%	30%	10%
ROOM INDEX	COEFFICIENT OF UTILISATION					
J	.29	.26	.24	.27	.24	.23
I	.36	.32	.31	.32	.30	.28
H	.39	.36	.34	.35	.33	.31
G	.43	.40	.37	.39	.36	.34
F	.46	.42	.39	.41	.38	.36
E	.49	.46	.44	.43	.41	.29
D	.53	.49	.47	.46	.44	.42
C	.55	.52	.49	.48	.46	.44
B	.58	.55	.53	.50	.48	.46
A	.59	.57	.54	.52	.50	.48

Metal Side Panels

Catalogue No.	Lamps	Cycles	Components				Overall Length
			Chassis	Enclosure	End Plates	Mounting Straps	
46220-60*	2 x 40W	60	9987-60	7792	1 Pair	1 Pair	49"
46220-60-IS**	2 x 40W	60	9987-60-IS	7792	1 Pair	1 Pair	49"

*For 25 cycle operation, units with dual frequency 25/60 cycle ballasts will be supplied if specified.
**Instant start.

Plastic Side Panels

Catalogue No.	Lamps	Cycles	Components				Overall Length
			Chassis	Enclosure	End Plates	Mounting Straps	
46240-60*	2 x 40W	60	9987-60	7793	1 Pair	1 Pair	49"
46240-60-IS**	2 x 40W	60	9987-60-IS	7793	1 Pair	1 Pair	49"

*For 25 cycle operation, units with dual frequency 25/60 cycle ballasts will be supplied if specified.
**Instant start.

Hanger Cat. Nos.

Description	Double Stem Adjustable 24" Standard†*	Single Stem Adjustable 8"***	Single Stem Adjustable 24"***
Metallic Grey	9925	7789	7719
White Enamel	9925W	7789W	7719W
Stud mounting strap	9999A	For mounting and connecting chassis with outlet box at chassis coupling.	

*Special length hangers will be supplied if specified.
†Where this hanger is to be used with dual frequency units specify with No. 9925A adapter.



FLUORESCENT SHIELDED UNITS

Day-Brite "Lenox" Units Hangers

"LENOX-2"—CONTINUOUS ROW

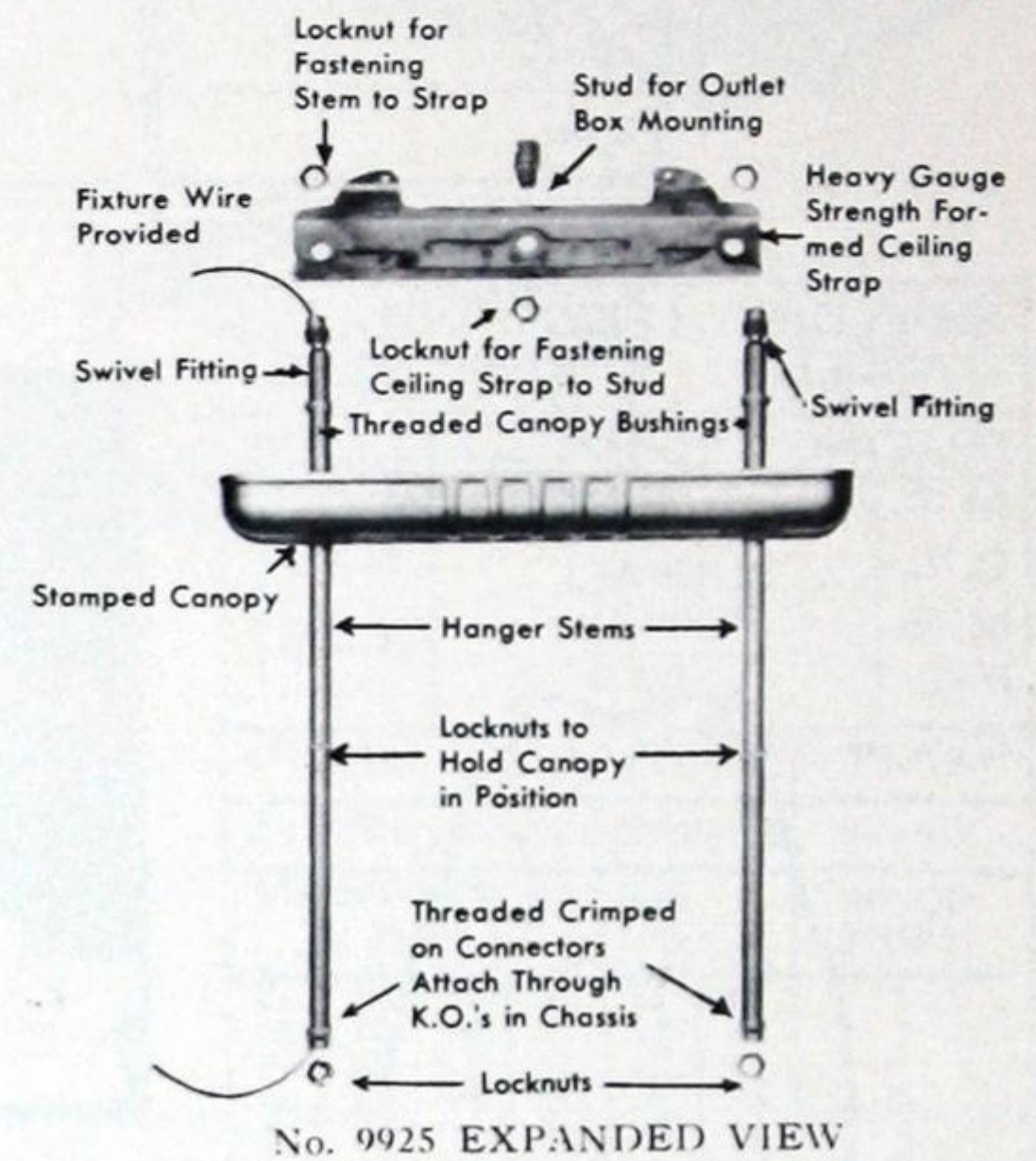
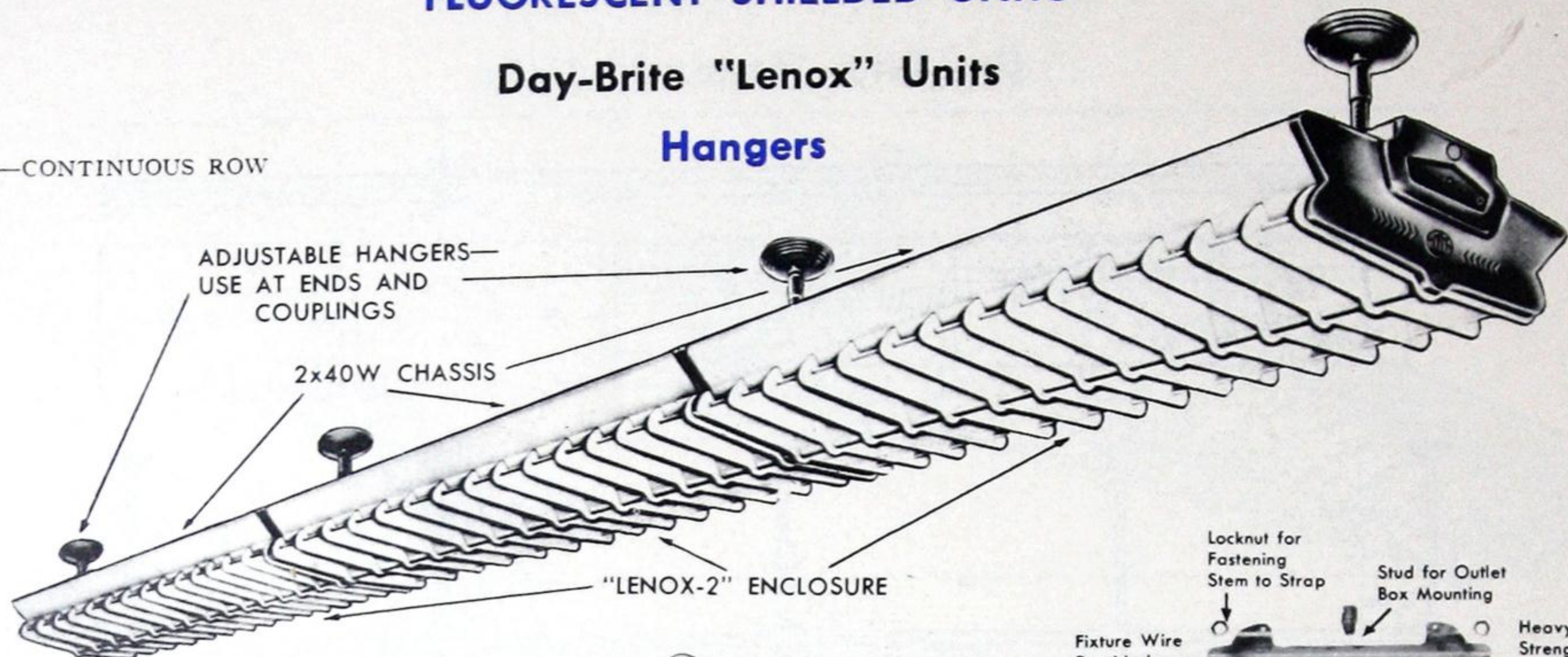

DOUBLE STEM
24" HANGER—STANDARD
No. 9925



For mounting and connecting chassis with outlet box at chassis coupling.

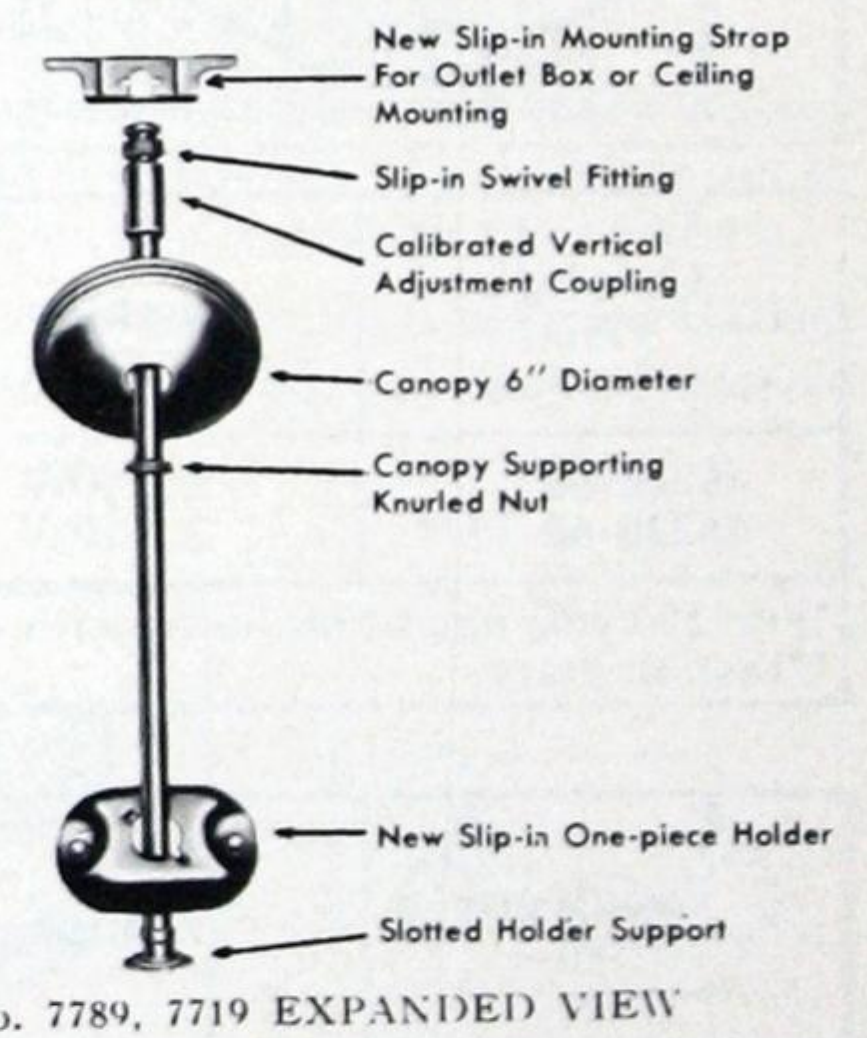

Enclosure is attached to chassis by easily accessible spring tension clips. No tools required.

Side panels are supported at top by rigid bar through full length of fixture ensuring maximum strength and rigidity.

Side panels are supported at the bottom through full length of fixture by lateral louvers.

V-shaped center louver provides additional light output in useful area of illumination.

Metal or plastic side panels

Lateral louvers finished in baked Super-White enamel. Interlocked through V-member and to plastic or metal side panels.

For easy maintenance enclosure is supported by service chains. May be unhooked for complete removal.

TYPICAL "LENOX-2" ENCLOSURE

Detachable End Plates



FLUORESCENT SHIELDED UNITS

Day-Brite "Lenox-4" Units

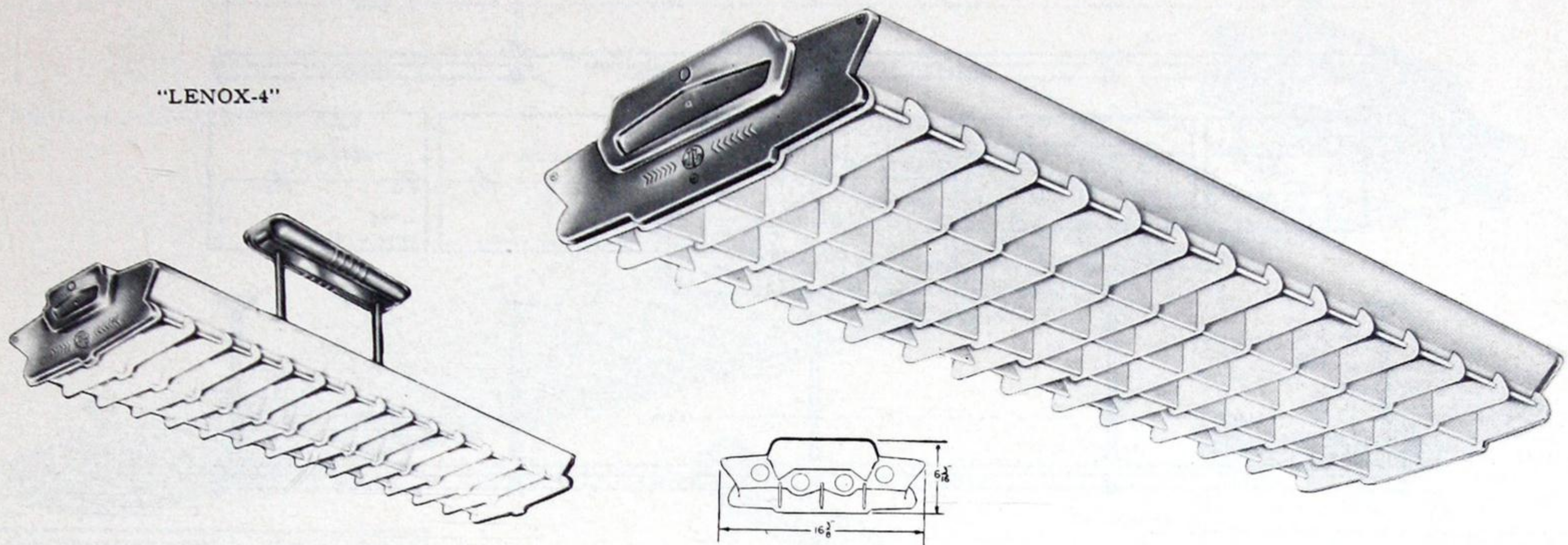

Complete units for four 40 watt fluorescent lamps. These lighting units have many applications. They are efficient and easy to install and maintain. They are designed for both surface and suspension mounting.

CHASSIS—Die-formed and welded steel construction with snap-on wireway cover. Finish baked Super-White enamel.

MOUNTING—Chassis is arranged for either surface or suspension mounting. The chassis is provided with all necessary holes and knockouts for quick fastening to ceiling or for suspension mounting and for wire connections.

"LENOX" ENCLOSURES—These are of an entirely new design supplied with all metal enclosing elements or with plastic side panels. The metal side panels and louver assembly are finished in baked Super-White enamel with the ends in baked Metallic Grey enamel. The longitudinal louvers are of double wall "BOXCO" construction providing extreme strength and stability and enhancing the appearance of the entire louver assembly and fixture.

SERVICING THE "LENOX" UNIT—The snap-on enclosure is supported to the chassis by spring tension clips and is easily lowered without the use of tools. Service chains support the enclosure when it is released from the chassis for cleaning. These chains can be unhooked from the chassis for complete removal of the enclosure if desired. Units can be relamped without disturbing the enclosure.

WIRING—All units are furnished wired and supplied with best quality fully compensated standard 2 x 40 watt ballasts, ensuring efficient starting and maximum lamp life and light output. They are equipped with standard type lamp and starter sockets, and standard starters. Automatic or manual reset starters will be supplied if specified.

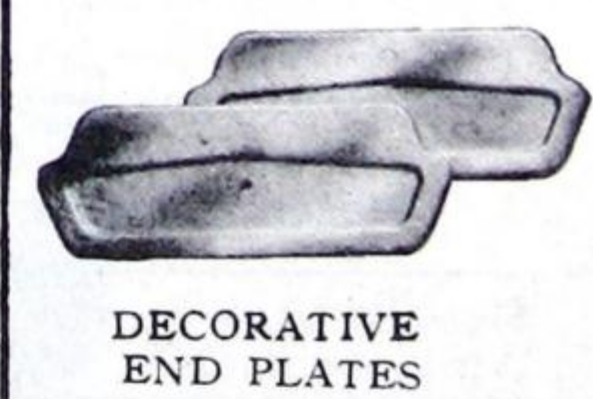
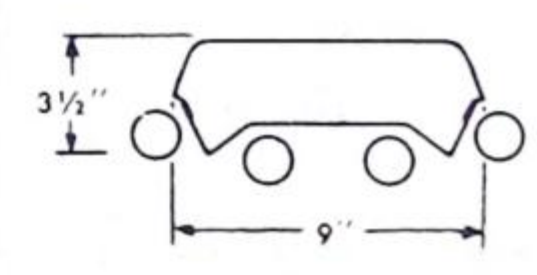
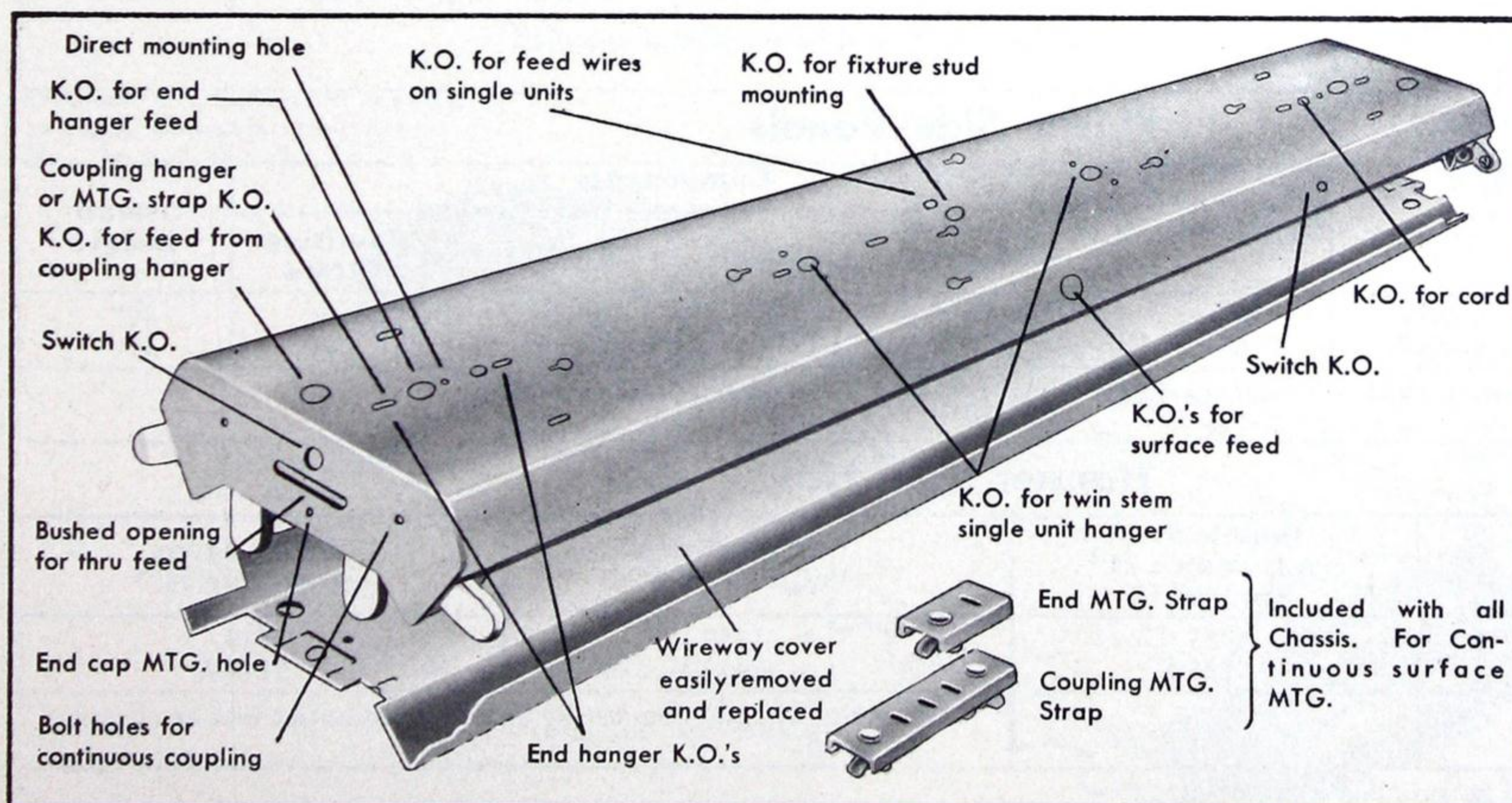

BASIC CHASSIS



FLUORESCENT SHIELDED UNITS

Day-Brite "Lenox-4" Units

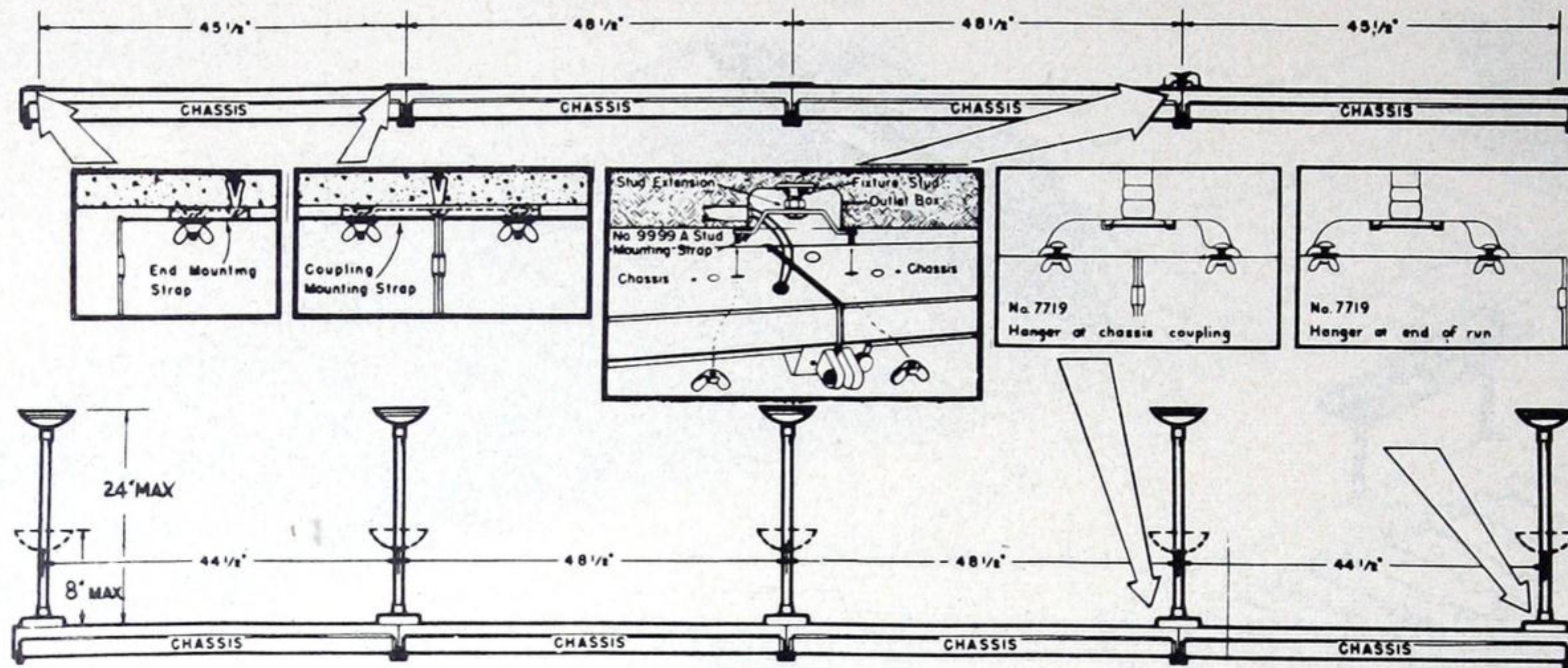

SHIELDING LENGTHWISE 22° ANGLE CROSSWISE 35°							
SPACING 1.25xMH		EFF 61%					
M.F.	"LENOX-4"	5.0% ↑					
G.70	SURFACE	56.0% ↓					
M.65	PLASTIC						
P.60	SIDES						
CEILING	75%	50%					
WALLS	50%	30%	10%	50%	30%	10%	
ROOM INDEX	COEFFICIENT OF UTILISATION						
J	.29	.26	.24	.27	.25	.23	
I	.35	.32	.30	.34	.31	.29	
H	.38	.35	.34	.37	.34	.33	
G	.41	.38	.37	.40	.37	.36	
F	.43	.41	.38	.41	.39	.37	
E	.46	.44	.42	.44	.43	.40	
D	.49	.46	.44	.47	.46	.43	
C	.51	.48	.46	.49	.47	.45	
B	.52	.50	.49	.50	.48	.47	
A	.54	.51	.50	.51	.49	.48	

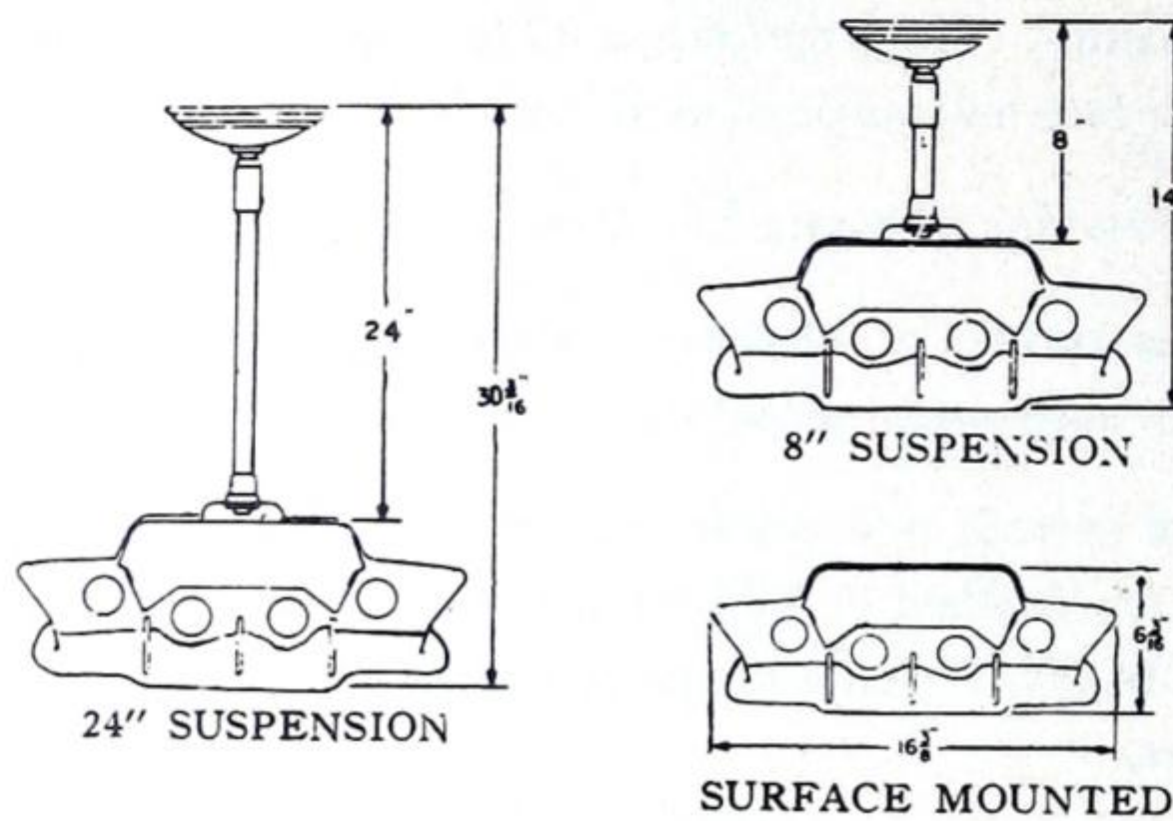

SHIELDING LENGTHWISE 22° ANGLE CROSSWISE 35°							
SPACING 1.25xMH		EFF 70.5%					
M.F.	"LENOX-4"	19.5% ↑					
G.70	SUSPENSION	51.0% ↓					
M.65	PLASTIC						
P.60	SIDES						
CEILING	75%	50%					
WALLS	50%	30%	10%	50%	30%	10%	
ROOM INDEX	COEFFICIENT OF UTILISATION						
J	.30	.27	.24	.28	.25	.24	
I	.36	.33	.31	.34	.31	.29	
H	.39	.36	.35	.37	.34	.33	
G	.42	.40	.38	.40	.38	.36	
F	.45	.43	.40	.41	.40	.38	
E	.49	.46	.43	.45	.43	.41	
D	.52	.49	.47	.48	.46	.44	
C	.54	.51	.48	.50	.47	.45	
B	.56	.53	.52	.51	.49	.48	
A	.57	.54	.53	.53	.50	.49	

Metal Side Panels

Catalogue No.	Lamps	Cycles	Components				Overall Length
			Chassis	Enclosure	End Plates	Mounting Straps	
46420-60*	4 x 40W	60	7790-60	7794	1 Pair	1 Pair	49"
46420-60-IS**	4 x 40W	60	7790-60-IS	7794	1 Pair	1 Pair	49"

*For 25 cycle operation, units with dual frequency 25/60 cycle ballasts will be supplied if specified.
**Instant start.

Plastic Side Panels

Catalogue No.	Lamps	Cycles	Components				Overall Length
			Chassis	Enclosure	End Plates	Mounting Straps	
46440-60*	4 x 40W	60	7790-60	7774	1 Pair	1 Pair	49"
46440-60-IS**	4 x 40W	60	7790-60-IS	7774	1 Pair	1 Pair	49"

*For 25 cycle operation, units with dual frequency 25/60 cycle ballasts will be supplied if specified.
**Instant start.

Hanger Cat. Nos.

Description	Double Stem Adjustable 24" Standard†	Single Stem Adjustable 8"*	Single Stem Adjustable 24"*
Metallic Grey	9925	7789	7719
White Enamel	9925W	7789W	7719W
Stud mounting strap	9999.A	For mounting and connecting chassis with outlet box at chassis coupling.	

*Special length hangers will be supplied if specified.
†Where this hanger is to be used with dual frequency units specify with No. 9925.A adapter.



FLUORESCENT SHIELDED UNITS

Day-Brite "Lenox-4" Units

Hangers

"LENOX-4"—CONTINUOUS ROW

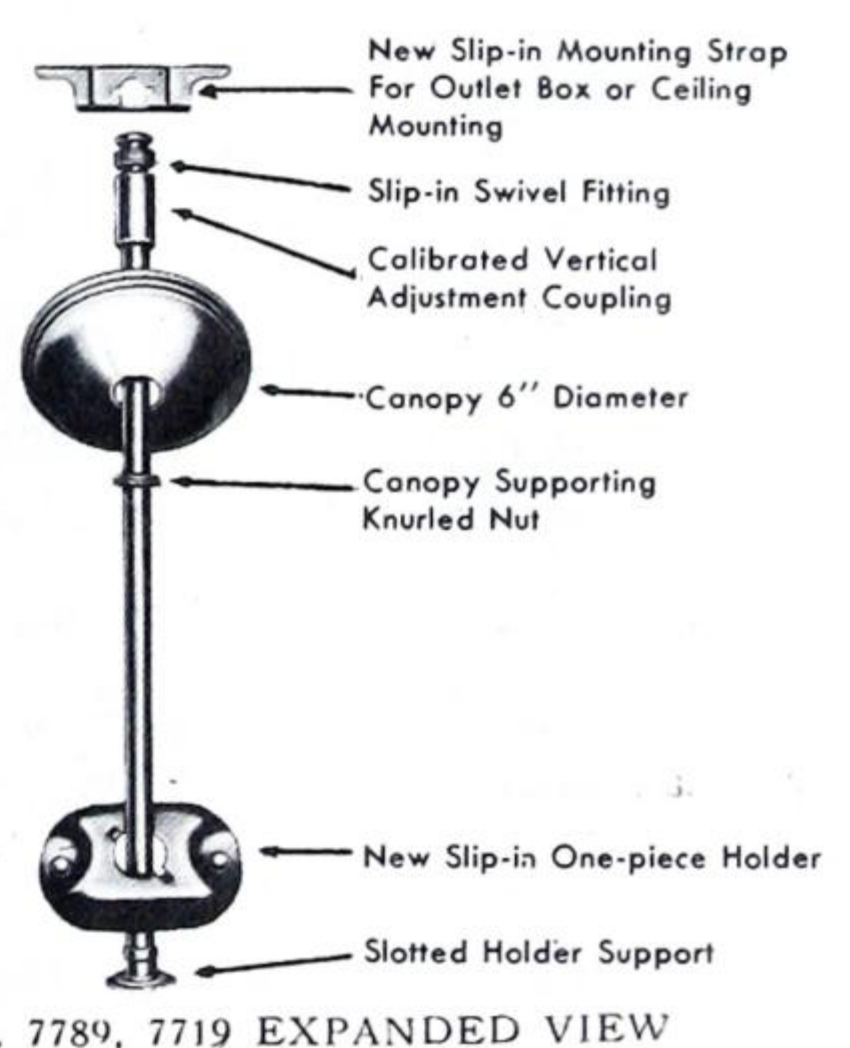
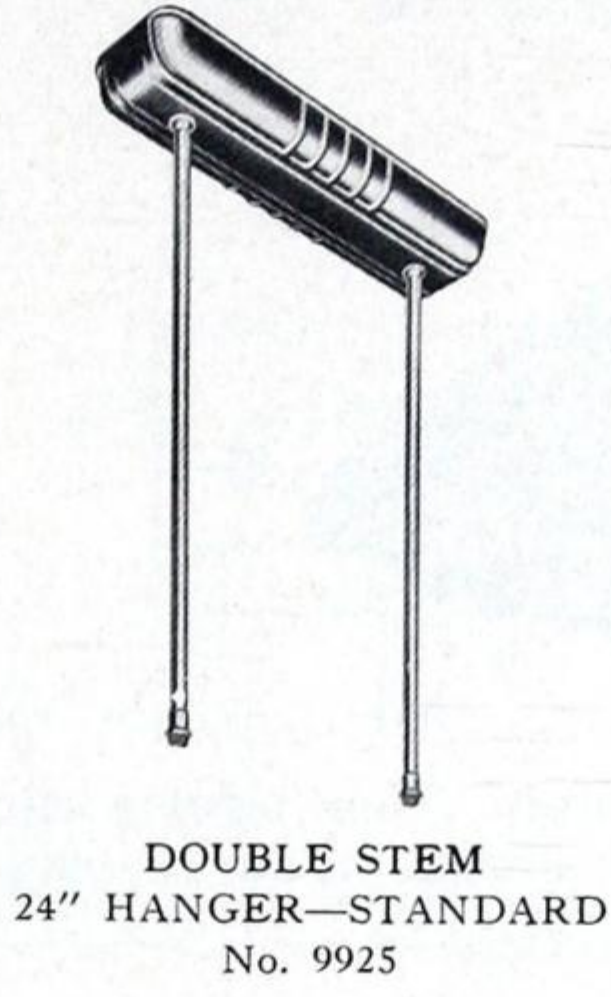
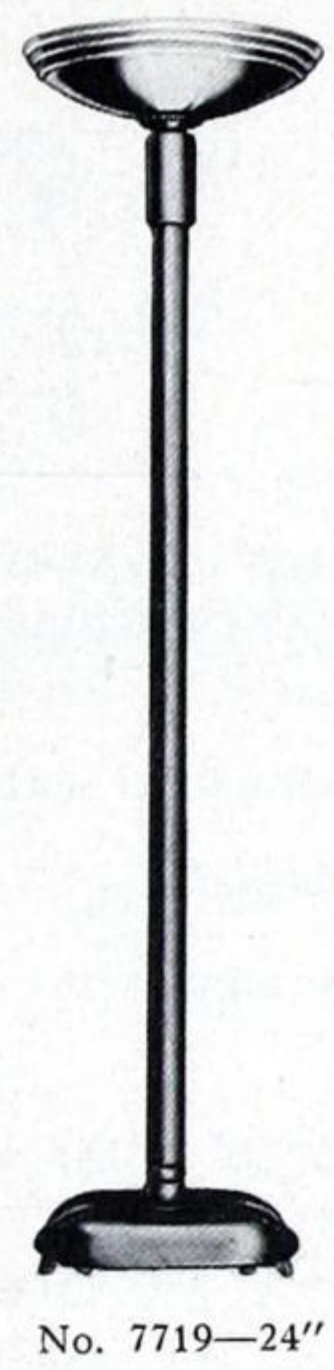
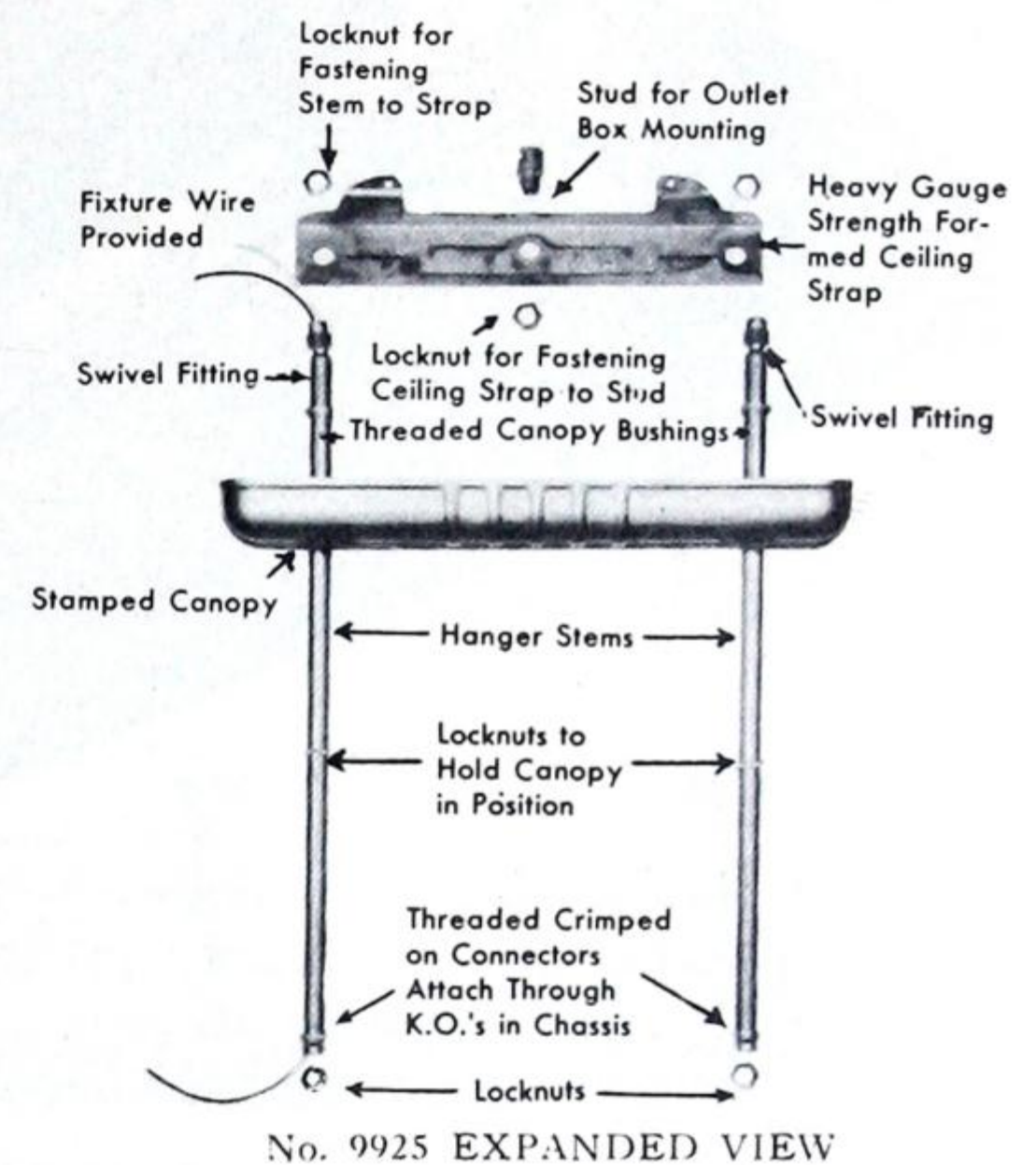
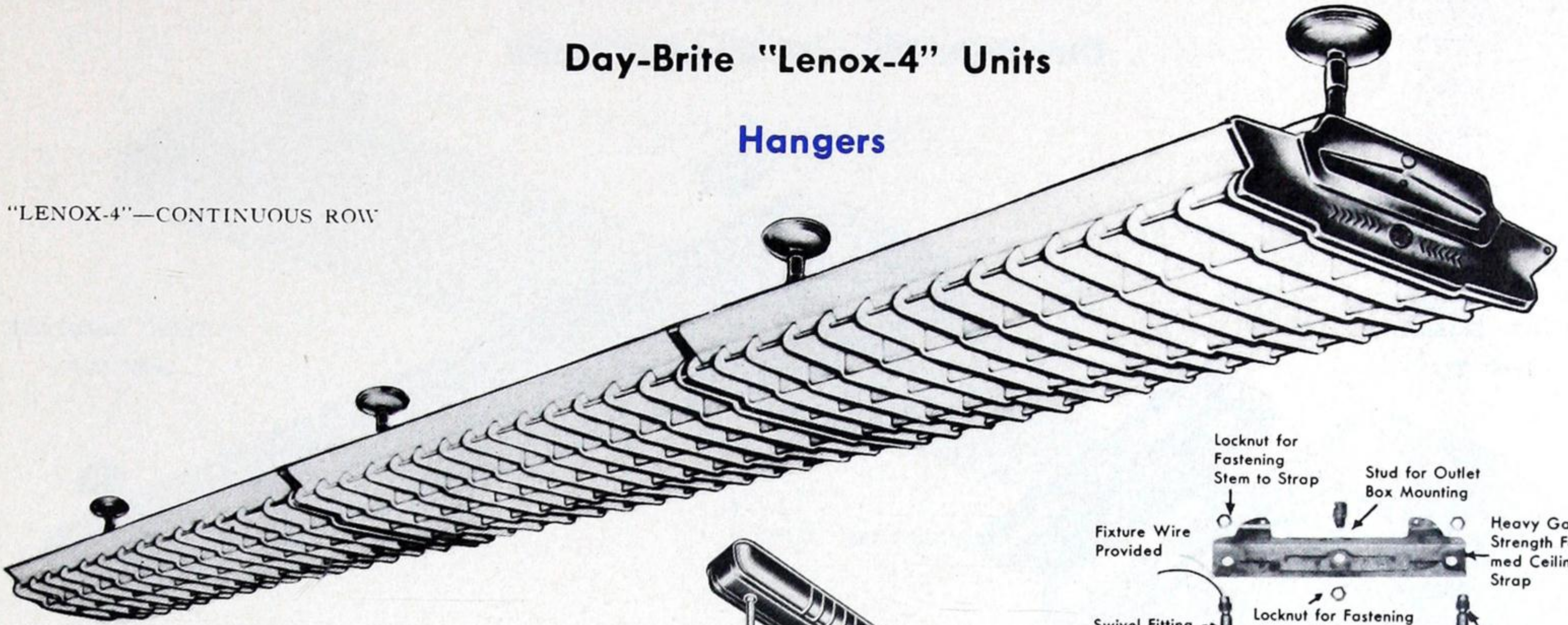

Enclosure is attached to chassis by easily accessible spring tension clips. No tools required.

Side panels are supported at top by rigid bar through full length of fixture ensuring maximum strength and rigidity.

Side panels are supported at bottom through full length of fixture by lateral louvers.

Interlocking Boxco louvers, double wall longitudinal members interlocked through lateral members to metal or plastic side panels.

Metal or plastic side panels.

For easy maintenance enclosure is supported by service chains. May be unhooked for complete removal.

Detachable End Plates

TYPICAL "LENOX-4" ENCLOSURE

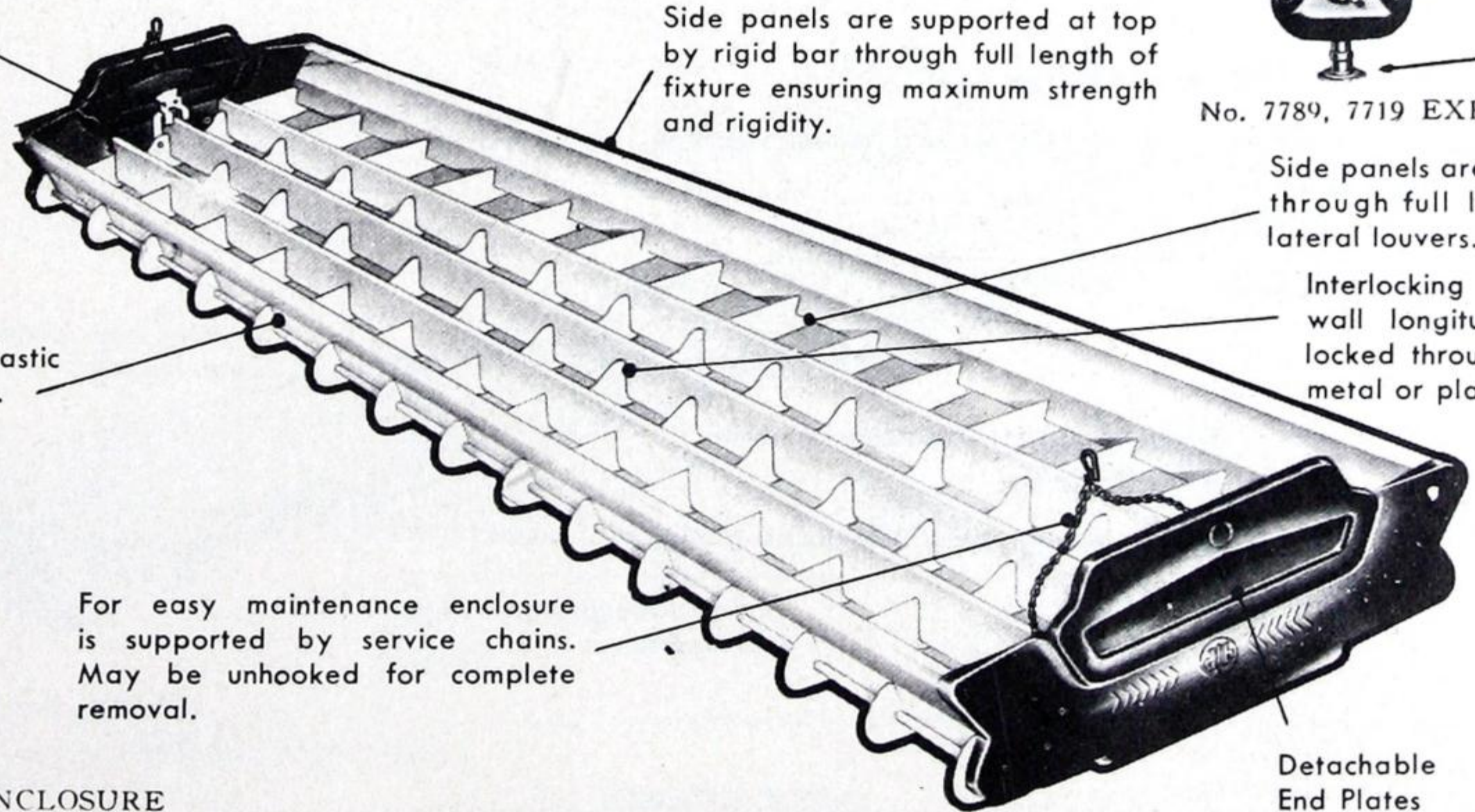



SLIMLINE SHIELDED UNITS Day-Brite "Luvex" Slimline Units

"LUVEX" SLIMLINE
2x48" T12

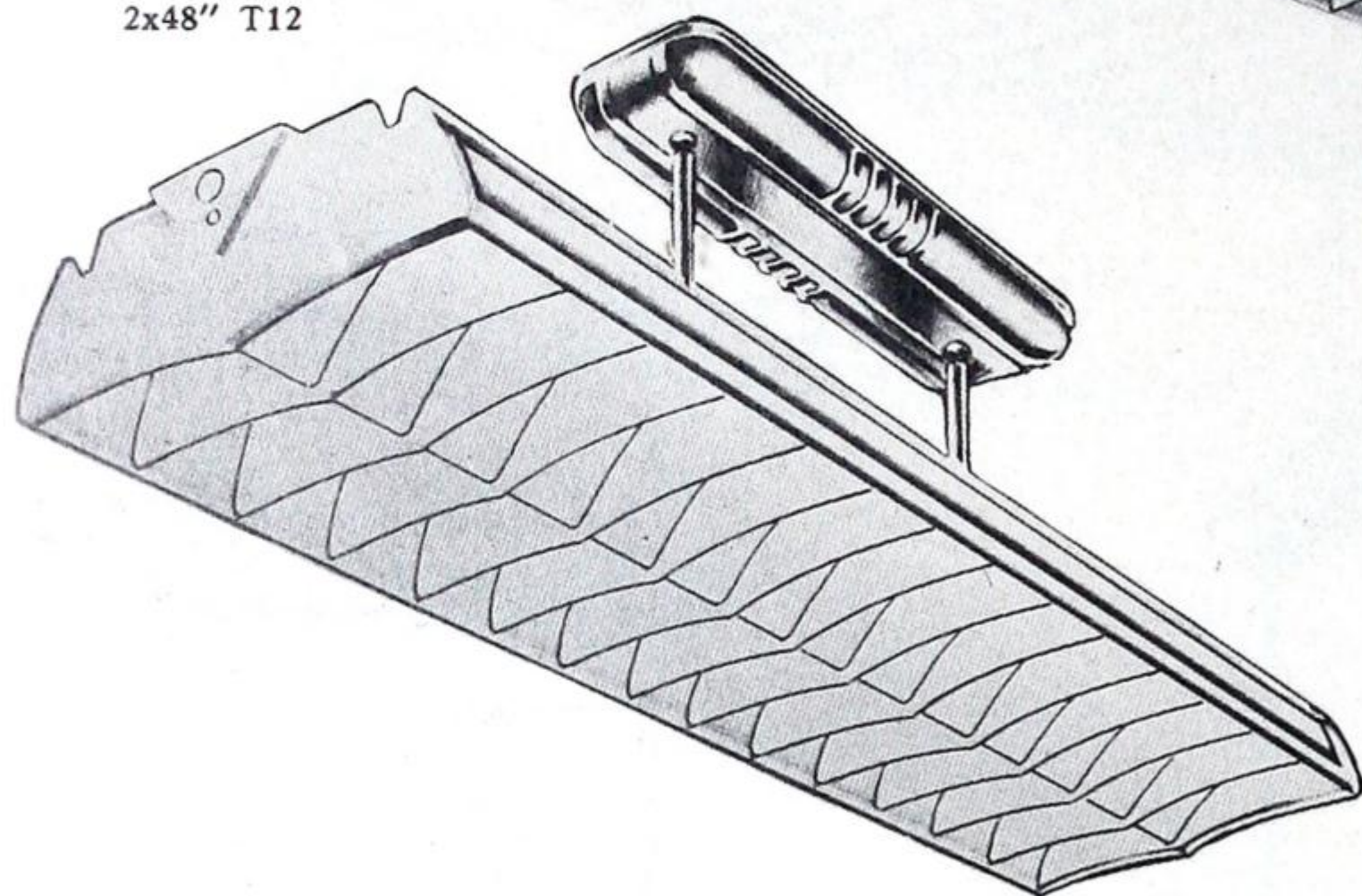

"LUVEX" SLIMLINE
2x96" T12

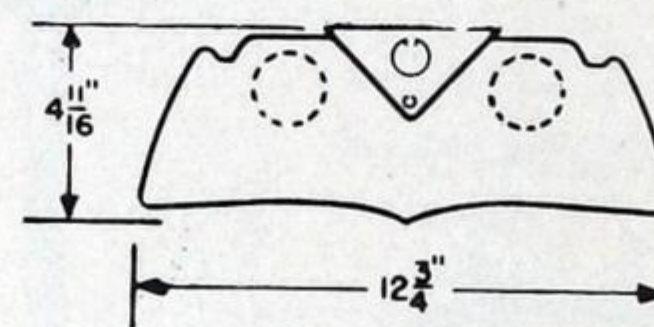
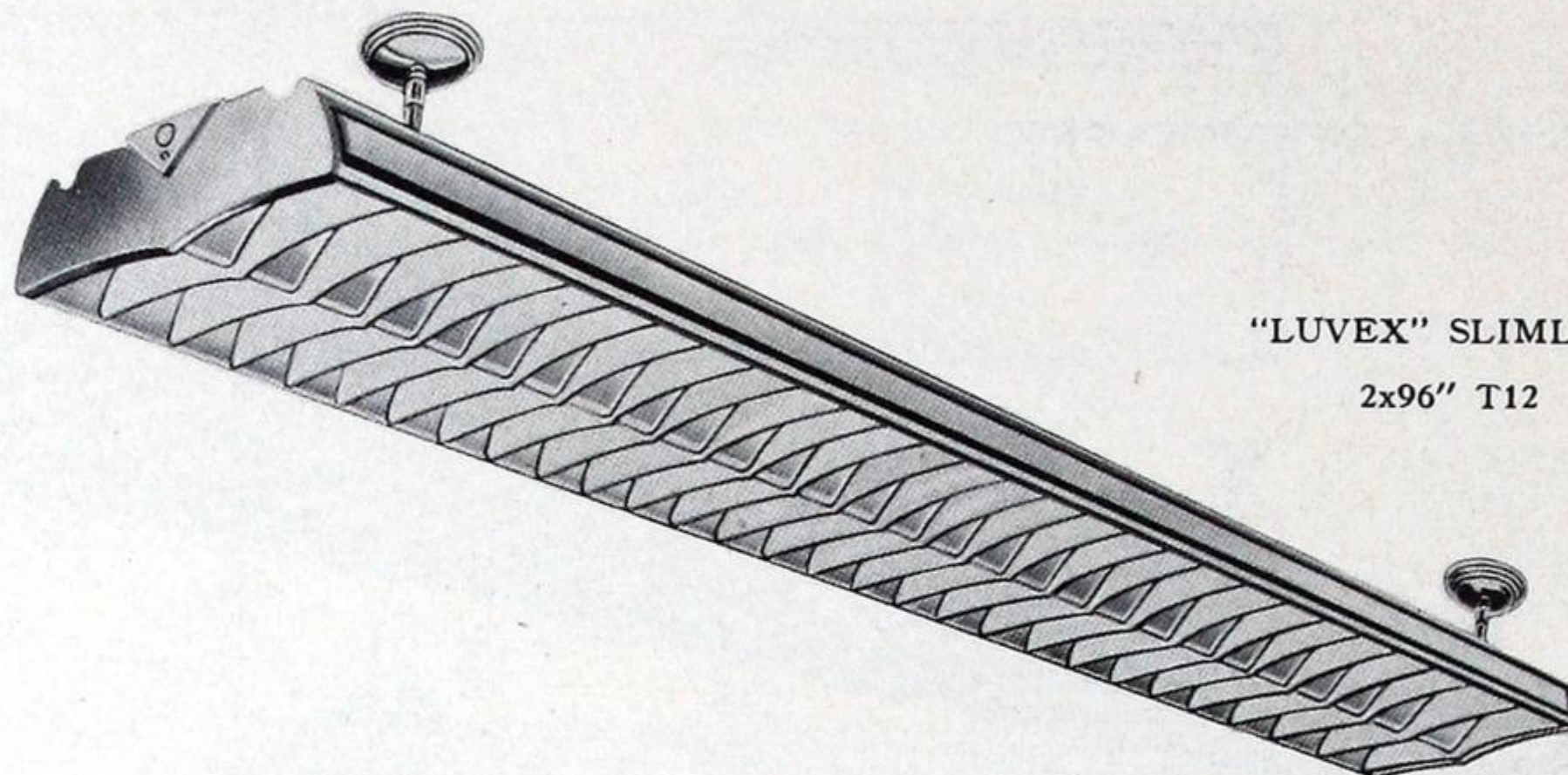

Complete units for two 48" or two 96" T12 slimline lamps. These lighting units have many applications. They are efficient and easy to install and maintain. To ensure the most even light distribution on the ceiling and pleasing brightness contrast the preferred method of installation for this unit is suspension mounted.

CHASSIS—Die-formed and welded steel construction throughout for uniformity and structural stability.

MOUNTING—Chassis is provided with all necessary holes and knockouts for easy installation.

"LUVEX" ENCLOSURES—These are of one-piece construction, ends, sides, centre louver and lateral louvers being completely pre-assembled to provide maximum strength.

SERVICING THE "LUVEX" UNIT—The entire "Luvex" enclosure assembly is supported to the wireway by snap catches. When the catches are released the enclosure is supported by service chains or may be completely removed from the chassis, simplifying installation or servicing of the unit. Maintenance is simple and inexpensive. The "Luvex" can be cleaned and relamped without disturbing a single part of the fixture, or releasing the enclosure assembly.

FINISH—Entire assembly and chassis finished in Super-White enamel.

WIRING—All units are furnished wired and supplied with best quality 2-lamp "Series Sequence" ballasts ensuring efficient starting and maximum lamp life and light output. No starters are required as Slimline lamps provide instant starting.

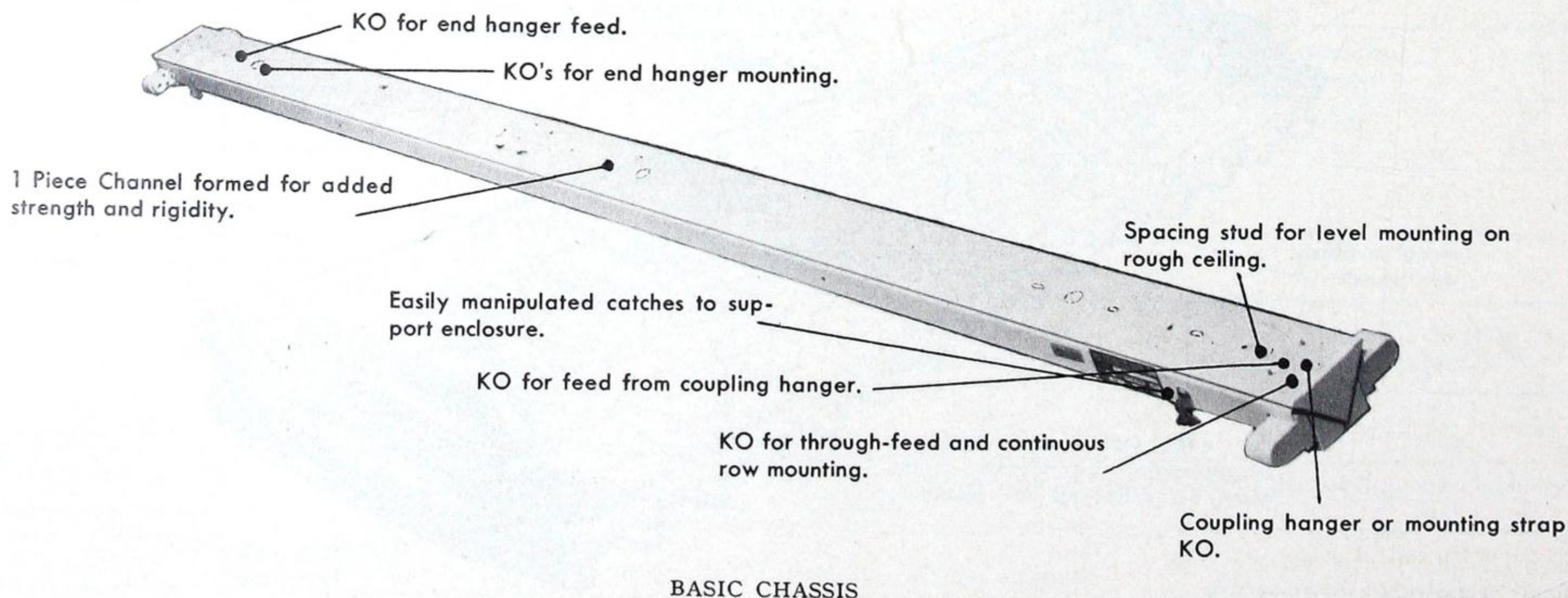



SLIMLINE SHIELDED UNITS

Day-Brite "Luvex" Slimline Units

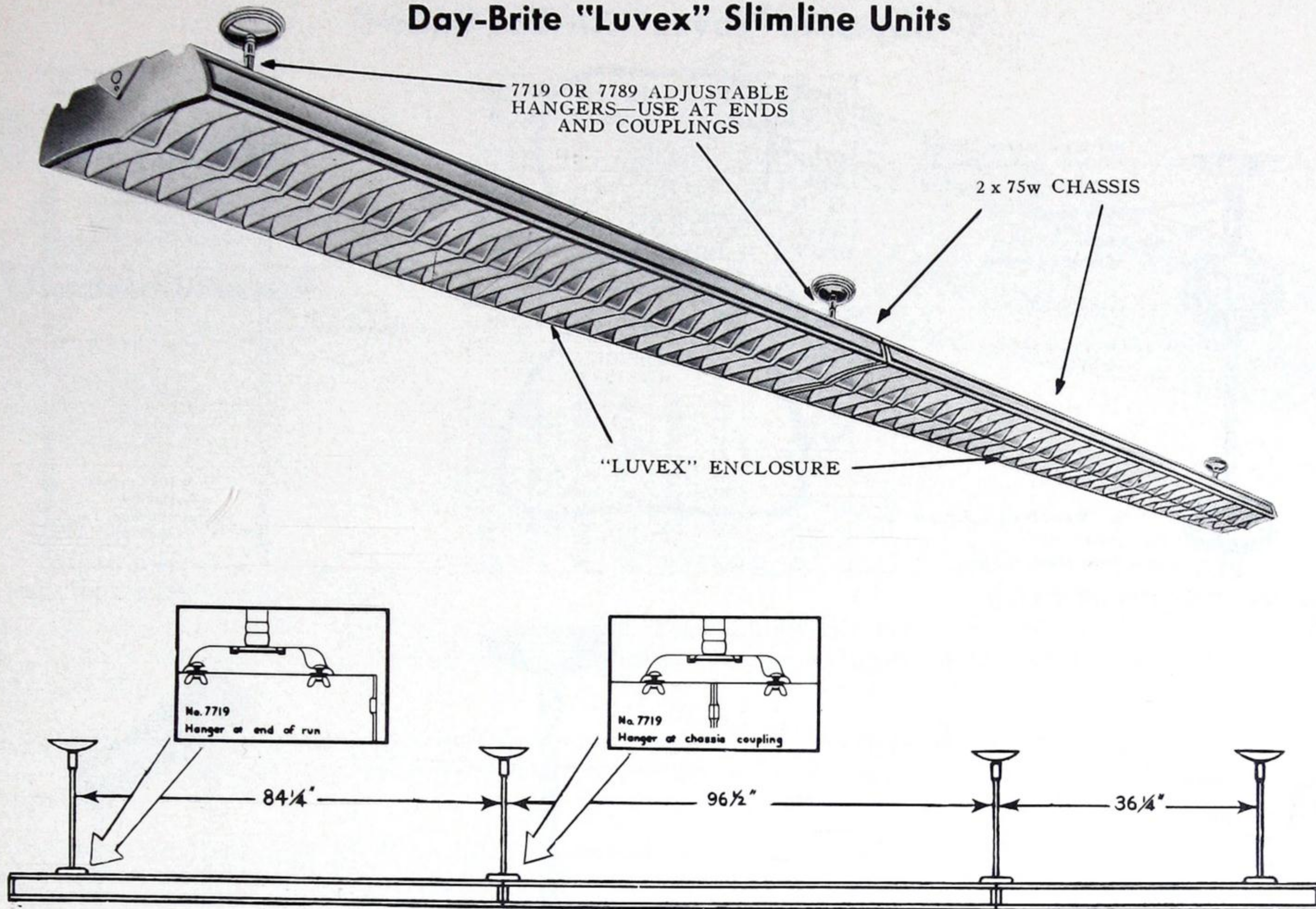

"Luvex" Units* For 48" T12 Slimline Lamps

Catalogue No.	Lamps	Volts	Cycles	ma	Overall Length
46265	2 x 48" T12	118	60	430	48 1/2"

*In addition to being mounted singly, these units may be used on the end of a row of 8 ft. units.

"Luvex" Units For 96" T12 Slimline Lamps

Catalogue No.	Lamps	Volts	Cycles	ma	Overall Length
96265	2 x 96" T12	118	60	430	96 1/2"

Hanger Cat. Nos.

Description	Double Stem Adjustable 24"†*	Single Stem Adjustable 8"*	Single Stem Adjustable 24"*
Metallic Grey White Enamel	9925 9925W	7789 7789W	7719 7719W

*Special length hangers will be supplied if specified.

†Recommended for 4' unit only.



SLIMLINE SHIELDED UNITS

Day-Brite "Luvex" Slimline Units

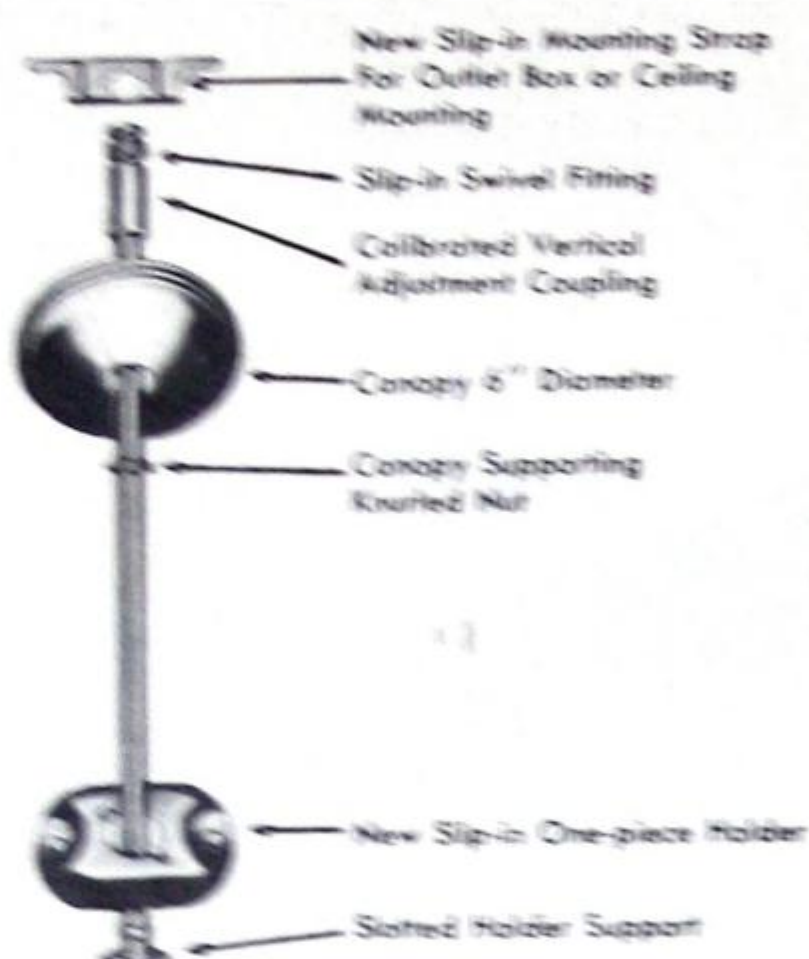

No. 7789, 7719 EXPANDED VIEW

SHIELDING LENGTHWISE 25°		ANGLE CROSSWISE 34°	
SPACING	1.0xMH	EFF	83.0%
M.F.	"LUVEX"		
G.75	96265		±2.5%
M.70	SUSPENSION		±40.5%
P.65			
CEILING	75%	50%	
WALLS	50% 30% 10%	50% 30% 10%	
ROOM INDEX	COEFFICIENT OF UTILISATION		
	.30	.26	.25
	.37	.33	.32
	.40	.38	.36
	.44	.41	.39
	.47	.44	.41
	.51	.46	.45
	.57	.55	.51
	.60	.57	.54
	.61	.59	.57

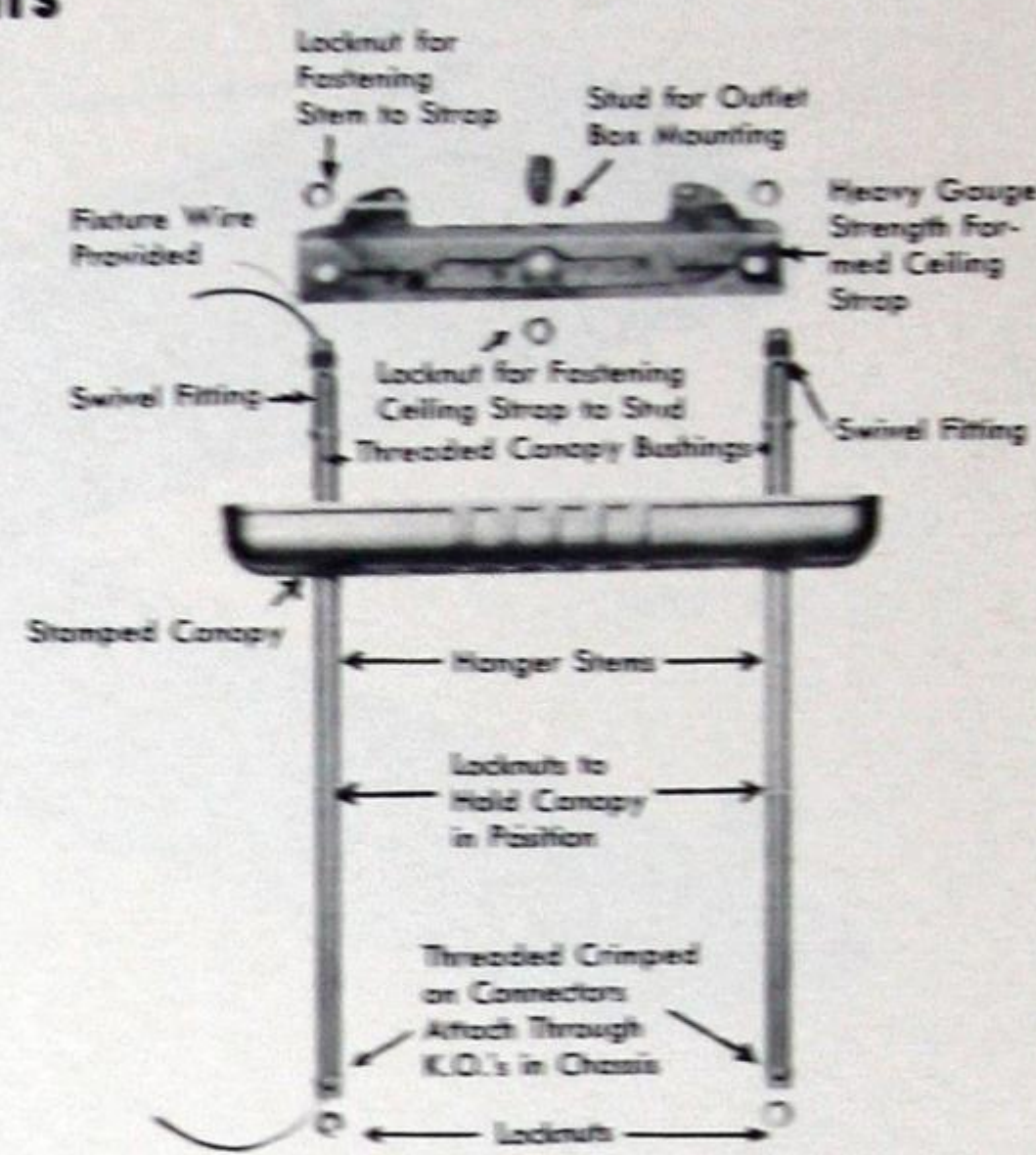

No. 9925 EXPANDED VIEW



No. 7789-8"



24" SUSPENSION



No. 7719-24"



DOUBLE STEM
24" HANGER—STANDARD
No. 9925

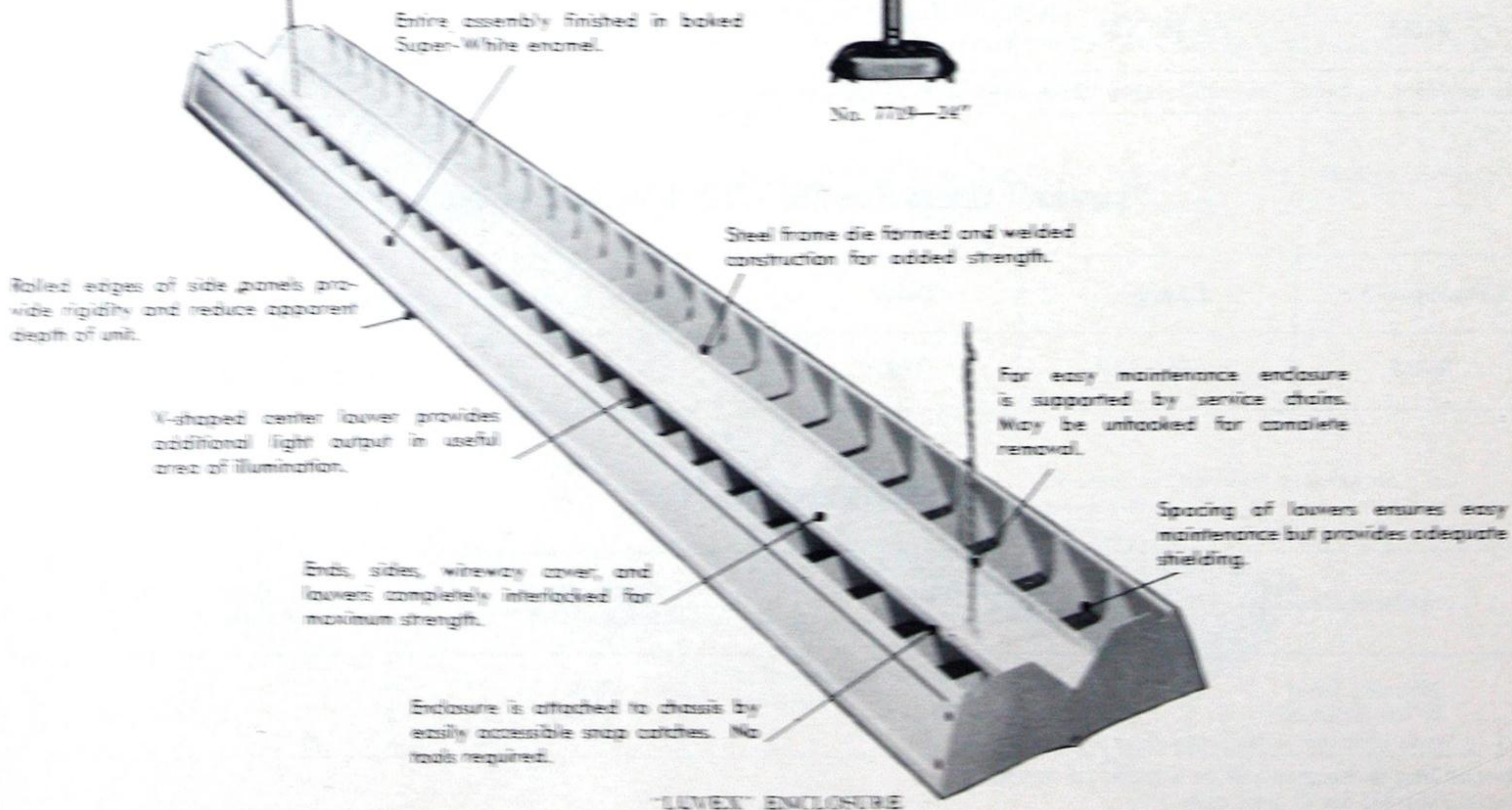

"LUVEX" ENCLOSURE



SLIMLINE SHIELDED UNITS

Day-Brite "Plexoline-2" Slimline Units

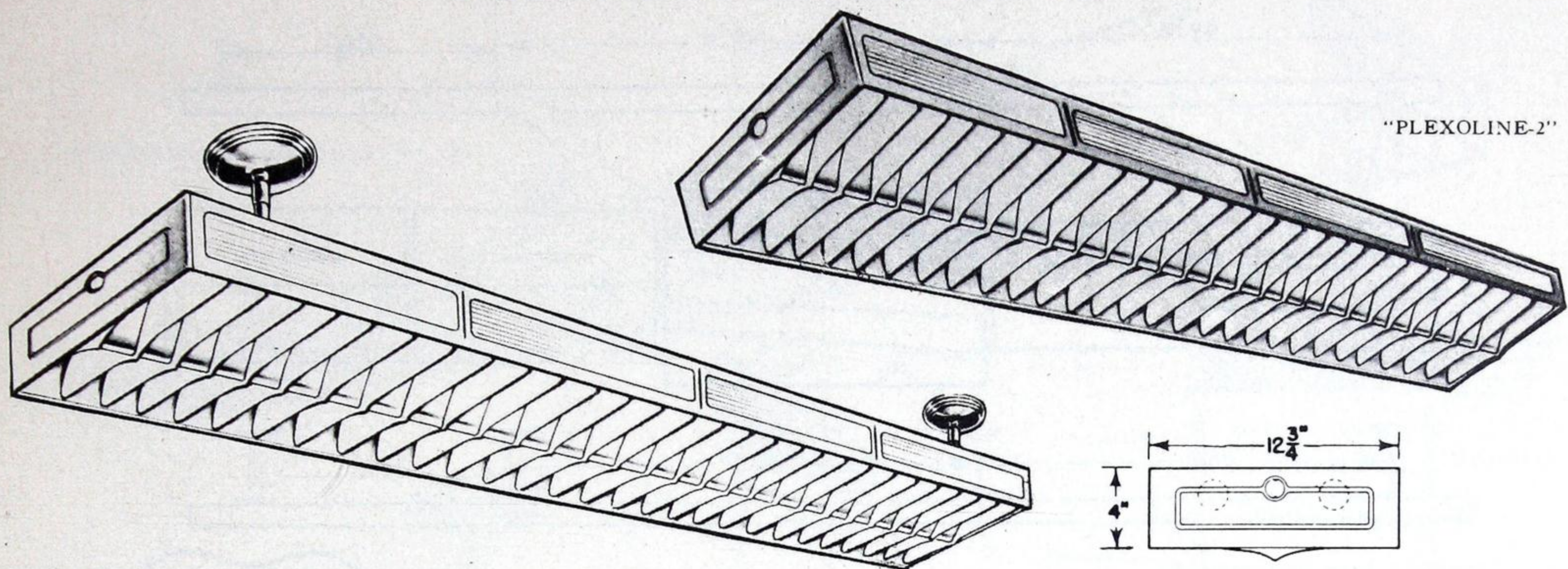

Complete units for two 48" T12 or two 96" T12 Slimline lamps. These lighting units have many applications. They are efficient and easy to install and maintain. They are designed for both surface and suspension mounting. Units for surface mounting are supplied with reflector plates.

CONSTRUCTION—Die-formed and welded steel construction throughout for uniformity and structural stability. Chassis and enclosure are pre-assembled in one piece for maximum strength. Side panels are of ribbed Albalite with low surface brightness and high transmission.

MOUNTING—Chassis is arranged for either surface or suspension mounting. The chassis is provided with all necessary holes and knockouts for quick fastening to ceiling or for suspension mounting and for wire connections.

"PLEXOLINE" LOUVERS—The entire louver assembly is held in position by simple snap catches and is provided with service chains to support the assembly for maintenance purposes. The assembly consists of the center wireway cover, with lateral louvers and side rails to ensure absolute rigidity and correct alignment of the louvers.

SERVICING THE "PLEXOLINE" UNIT—The Plexoline louver assembly is supported by snap catches and service chains, allowing simple and inexpensive maintenance.

FINISH—Enclosure, chassis, and louver assembly finished in Super-White enamel.

WIRING—All units are furnished wired and supplied with best quality 2-lamp "Series Sequence" ballasts ensuring efficient starting, and maximum lamp life and light output. No starters are required as Slimline lamps provide instant starting.

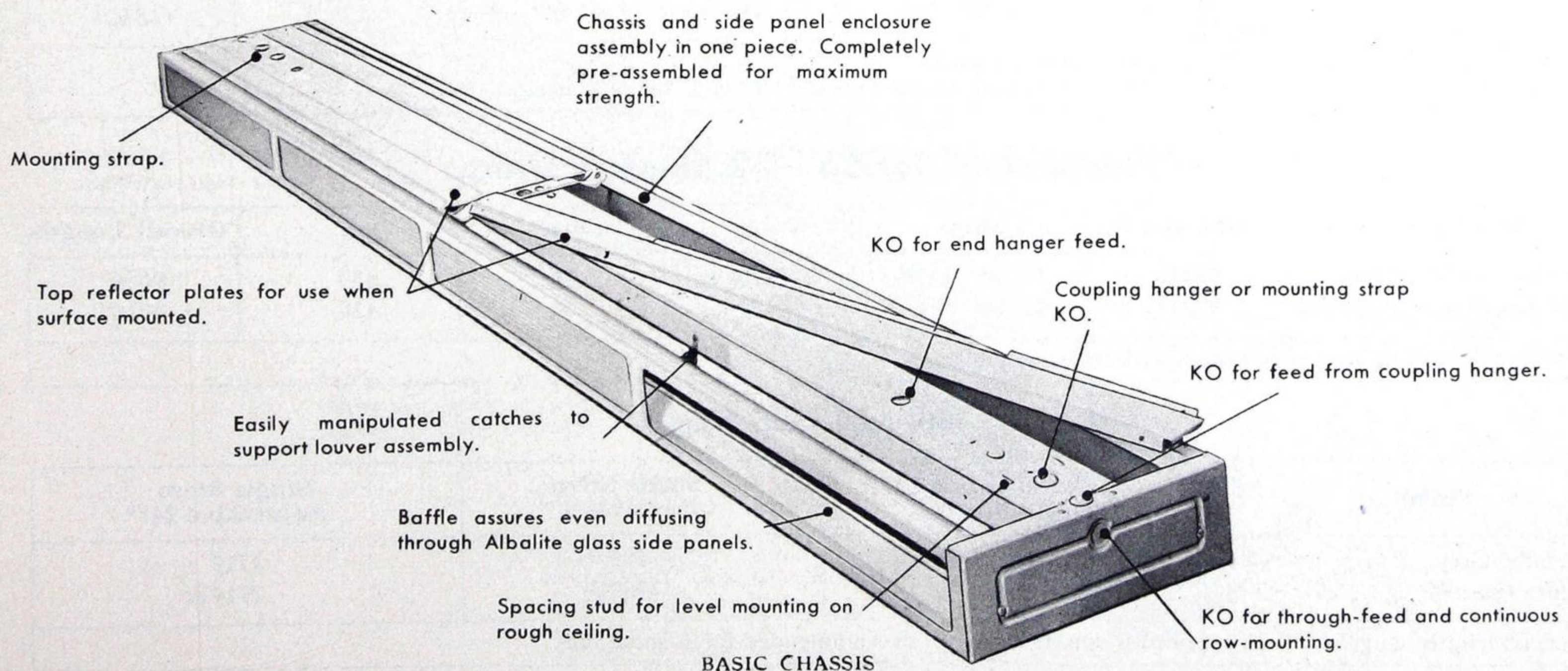



SLIMLINE SHIELDED UNITS

Day-Brite "Plexoline-2" Slimline Units

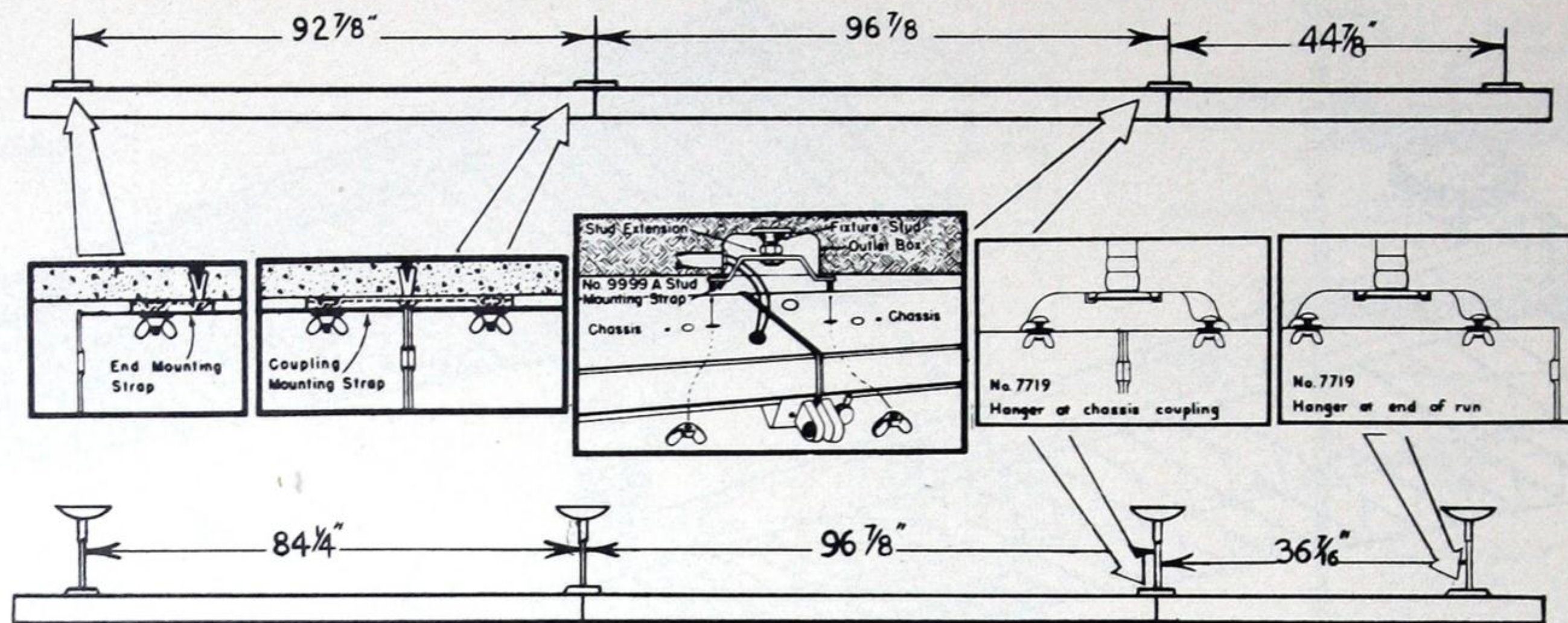

SHIELDING ANGLE		LENGTHWISE 20°		CROSSWISE 31°		
SPACING 1.2xMH		EFF 64.1%				
M.F.	"PLEXOLINE-2"	9.4%				
G.75	97200	54.7%				
M.70	SURFACE					
P.65						
CEILING	75%	50%				
WALLS	50%	30%	10%	50%	30%	10%
ROOM INDEX	COEFFICIENT OF UTILISATION					
J	.28	.25	.22	.27	.23	.22
I	.34	.32	.30	.33	.30	.29
H	.38	.35	.33	.36	.34	.32
G	.41	.38	.36	.39	.37	.35
F	.43	.41	.38	.41	.39	.37
E	.47	.44	.42	.45	.43	.40
D	.50	.47	.45	.48	.45	.43
C	.52	.49	.46	.49	.47	.45
B	.54	.51	.49	.51	.49	.47
A	.56	.53	.51	.53	.50	.48

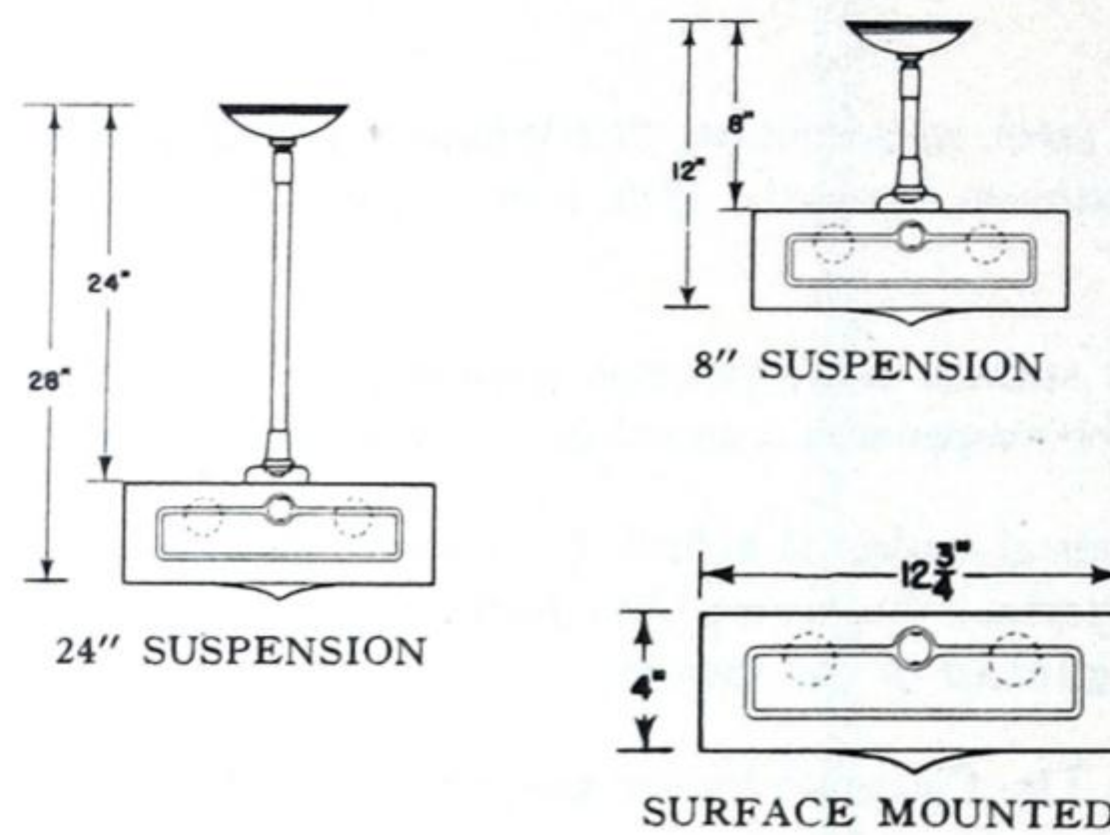

SHIELDING ANGLE		LENGTHWISE 20°		CROSSWISE 31°		
SPACING 1.2xMH		EFF 81.0%				
M.F.	"PLEXOLINE-2"	40.0%				
G.75	97203	41.0%				
M.70	SUSPENSION					
P.65						
CEILING	75%	50%				
WALLS	50%	30%	10%	50%	30%	10%
ROOM INDEX	COEFFICIENT OF UTILISATION					
J	.29	.24	.22	.25	.23	.20
I	.35	.31	.29	.31	.28	.26
H	.39	.35	.33	.34	.32	.30
G	.43	.39	.36	.38	.35	.33
F	.46	.42	.39	.40	.37	.35
E	.50	.46	.43	.44	.41	.38
D	.54	.50	.47	.47	.44	.42
C	.56	.52	.49	.49	.46	.44
B	.59	.56	.54	.51	.49	.46
A	.61	.58	.56	.53	.50	.48

"Plexoline-2" for 48" T12 Slimline Lamps†

Description	Catalogue No.	Lamps	Volts	Cycles	ma	Overall Length
For Surface Mounting*	47200	2 x 48" T12	118	60	430	48 7/8"
For Suspension Mounting	47203	2 x 48" T12	118	60	430	48 7/8"

*Surface Mounting unit is equipped with reflector plates.
†In addition to being mounted singly these units may be used on the end of a row of 8' units.

"Plexoline-2" for 96" T12 Slimline Lamps

Description	Catalogue No.	Lamps	Volts	Cycles	ma	Overall Length
For Surface Mounting*	97200	2 x 96" T12	118	60	430	96 7/8"
For Suspension Mounting	97203	2 x 96" T12	118	60	430	96 7/8"

*Surface Mounting unit is equipped with reflector plates.

Hanger Cat. Nos.

Finish	Double Stem Adjustable 24"†*	Single Stem Adjustable 8"*	Single Stem Adjustable 24"†*
Metallic Grey	9925	7789	7719
White Enamel	9925W	7789W	7719W

*Special length hangers will be supplied if specified. †Recommended for 4' units only.



SLIMLINE SHIELDED UNITS

Day-Brite "Plexoline-2" Slimline Units

Hangers

"PLEXOLINE-2"—CONTINUOUS ROW

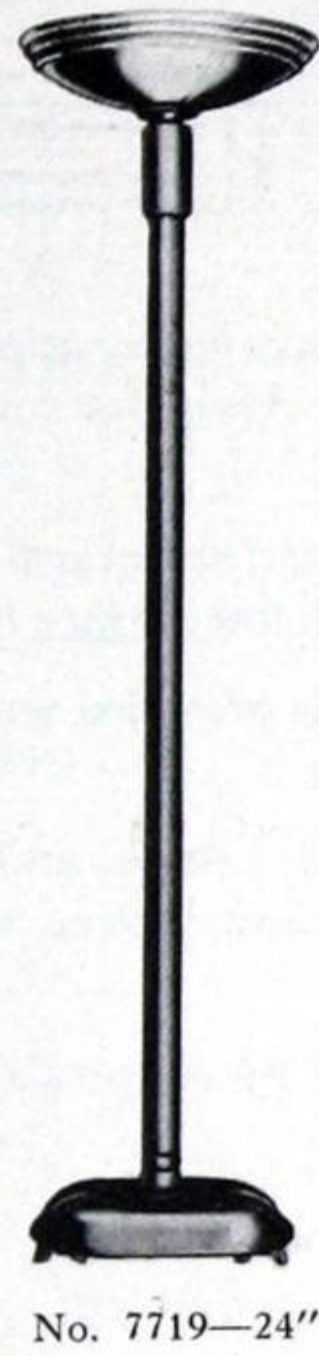
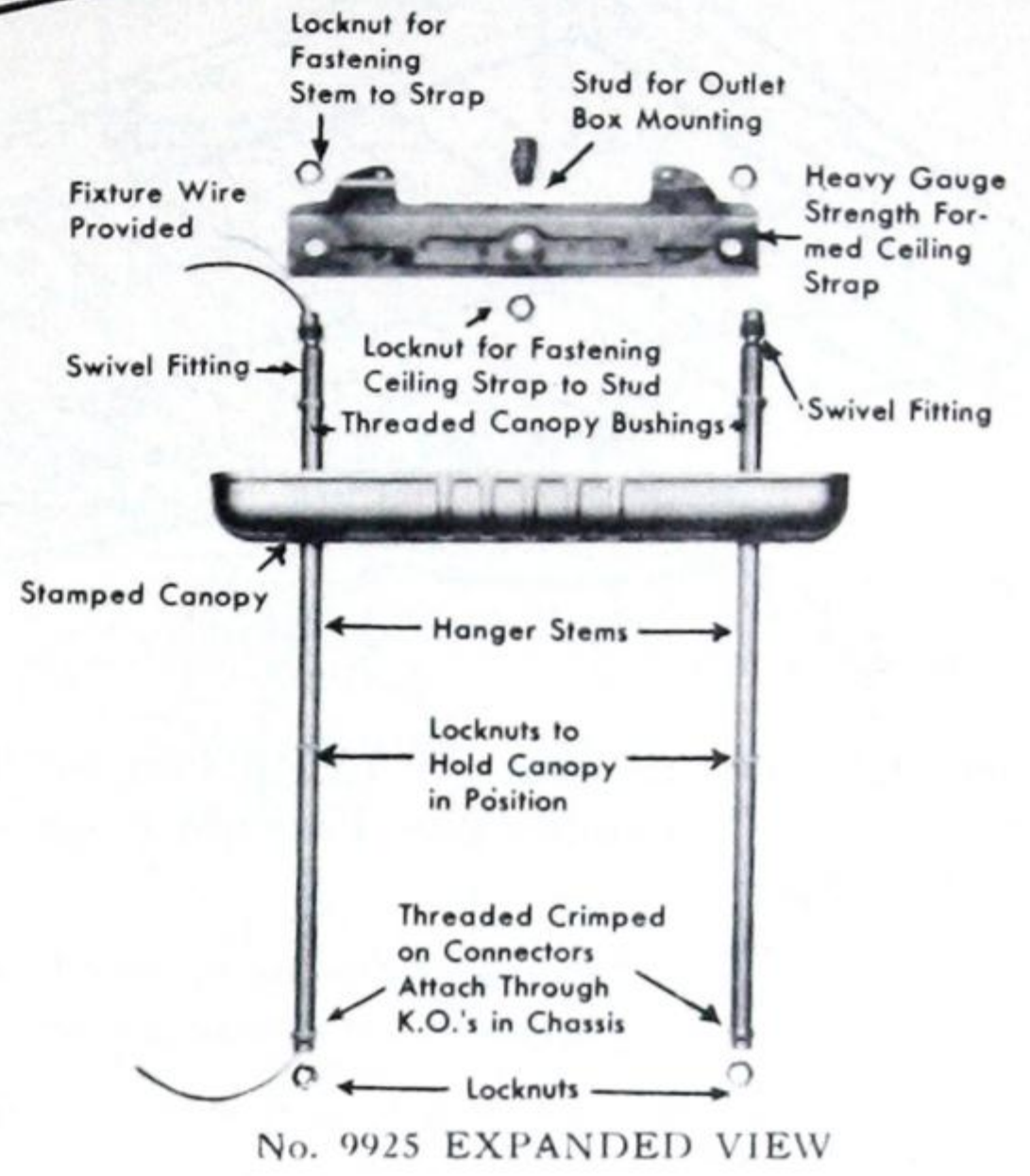

DOUBLE STEM
24" HANGER—STANDARD
No. 9925

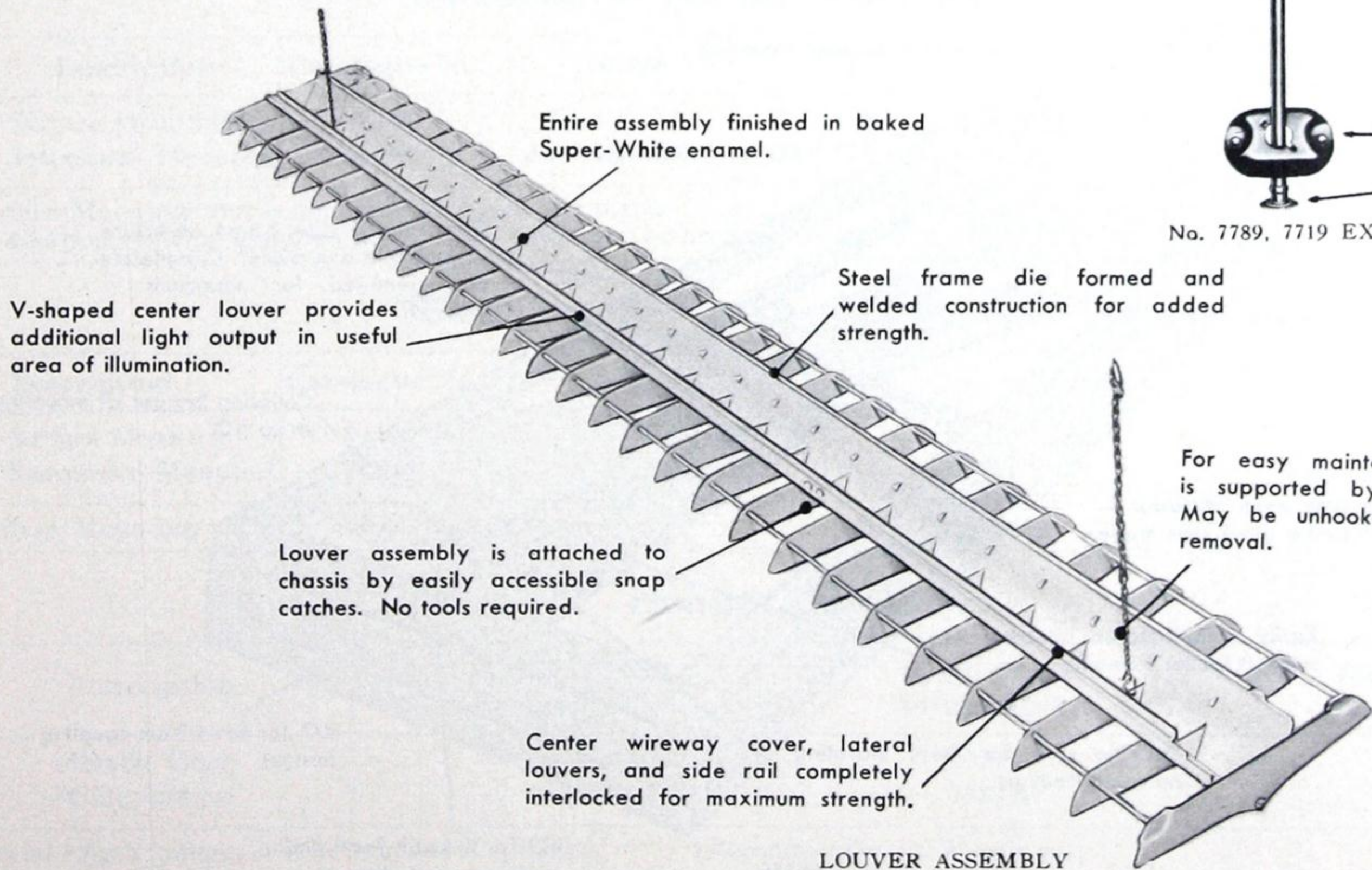
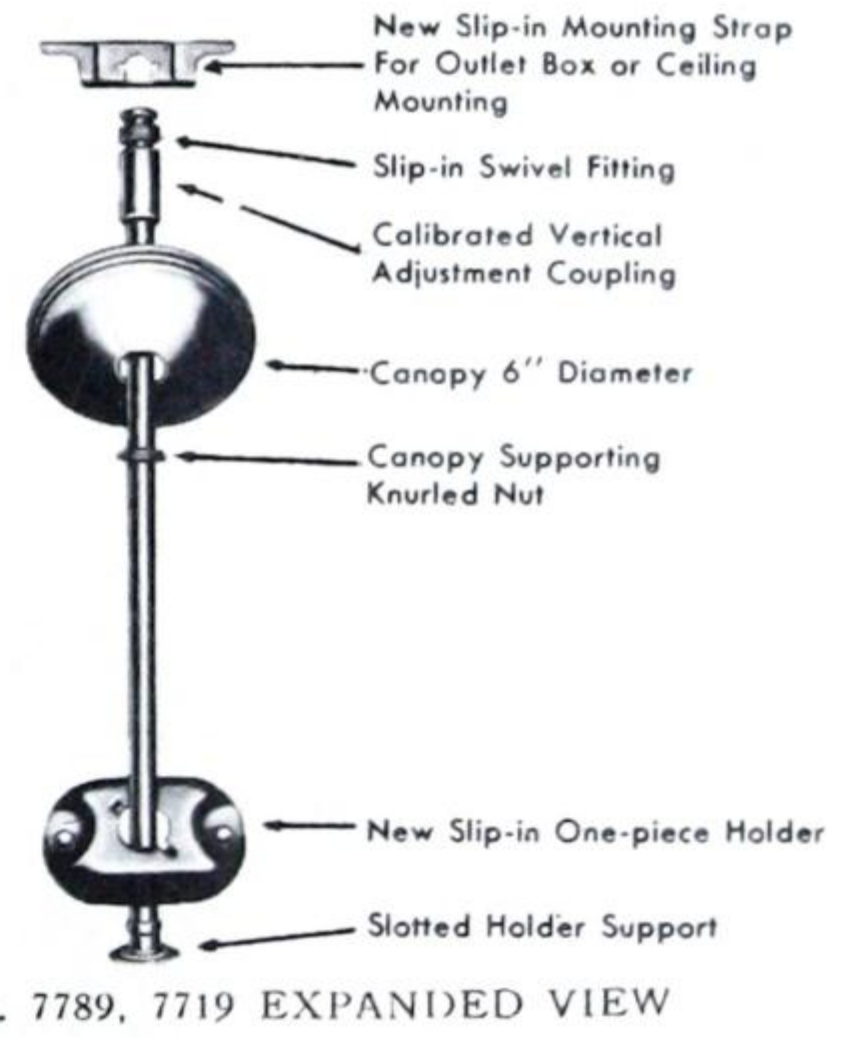



SLIMLINE SHIELDED UNITS

Day-Brite "Plexoline-4" Slimline Units

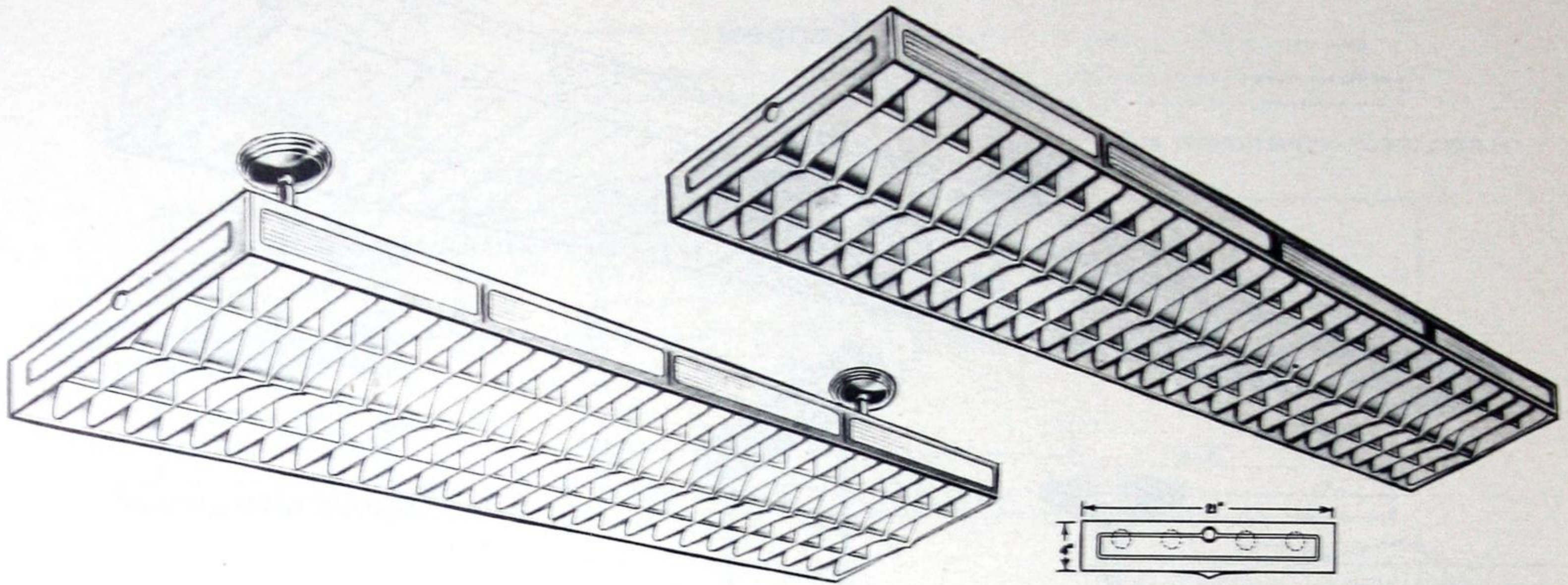

Complete units for four 48" T12 or four 96" T12 Slimline lamps. These lighting units have many applications. They are efficient and easy to install and maintain. They are designed for both surface and suspension mounting. Units for surface mounting are supplied with reflector plates.

CONSTRUCTION—Die-formed and welded steel construction throughout for uniformity and structural stability. Chassis and enclosure are pre-assembled in one piece for maximum strength. Side panels are of ribbed Albalite with low surface brightness and high transmission.

MOUNTING—Chassis is arranged for either surface or suspension mounting. The chassis is provided with all necessary holes and knock-outs for quick fastening to ceiling or for suspension mounting and for wire connections.

"PLEXOLINE" LOUVERS—The entire louver assembly is held in position by simple snap catches and is provided with service chains to support the assembly for maintenance purposes. The assembly consists of the center wireway cover, with lateral louvers and side rails to ensure absolute rigidity and correct alignment of the louvers.

SERVICING THE "PLEXOLINE" UNIT—The Plexoline louver assembly is supported by snap catches and service chains, allowing simple and inexpensive maintenance.

FINISH—Enclosure, chassis, and louver assembly finished in Super-White enamel.

WIRING—All units are furnished wired and supplied with best quality 2-lamp "Series Sequence" ballasts ensuring efficient starting and maximum lamp life and light output. No starters are required as Slimline lamps provide instant starting.

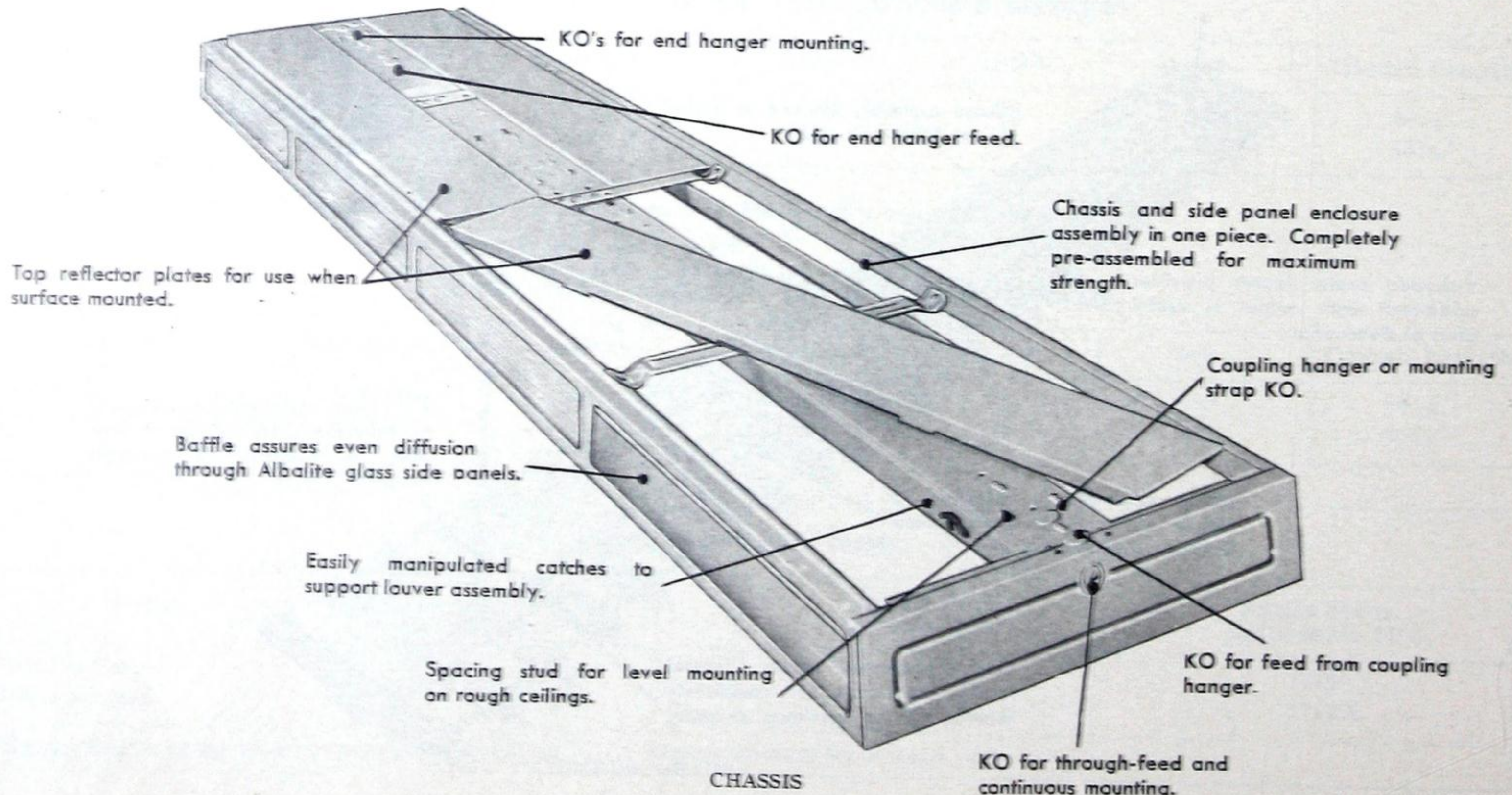



SLIMLINE SHIELDED UNITS

Day-Brite "Plexoline-4" Slimline Units

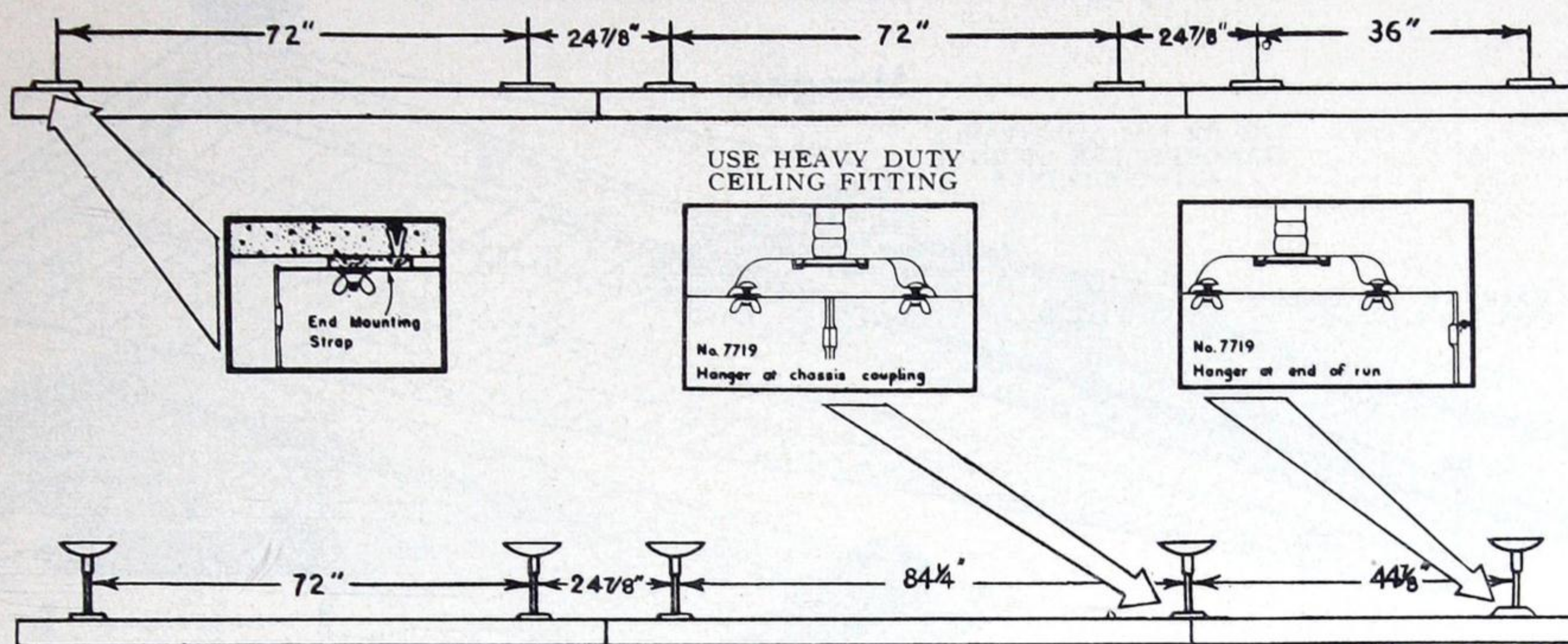

SHIELDING LENGTHWISE 19° ANGLE CROSSWISE 30°	
SPACING 1.2xMH	EFF 65.4%
M.F. "PLEXOLINE-4"	6.0%
G.75 97400	59.4%
M.70 SURFACE	
P.65	
CEILING	75% 50%
WALLS	50% 30% 10% 50% 30% 10%
ROOM INDEX	COEFFICIENT OF UTILISATION
J	.29 .25 .23 .28 .25 .23
I	.35 .32 .30 .34 .31 .29
H	.38 .36 .34 .38 .33 .33
G	.42 .40 .37 .41 .38 .36
F	.45 .42 .39 .43 .41 .38
E	.47 .46 .43 .46 .44 .42
D	.51 .48 .46 .49 .47 .46
C	.53 .50 .48 .51 .49 .47
B	.55 .52 .51 .53 .51 .49
A	.56 .54 .52 .54 .52 .50

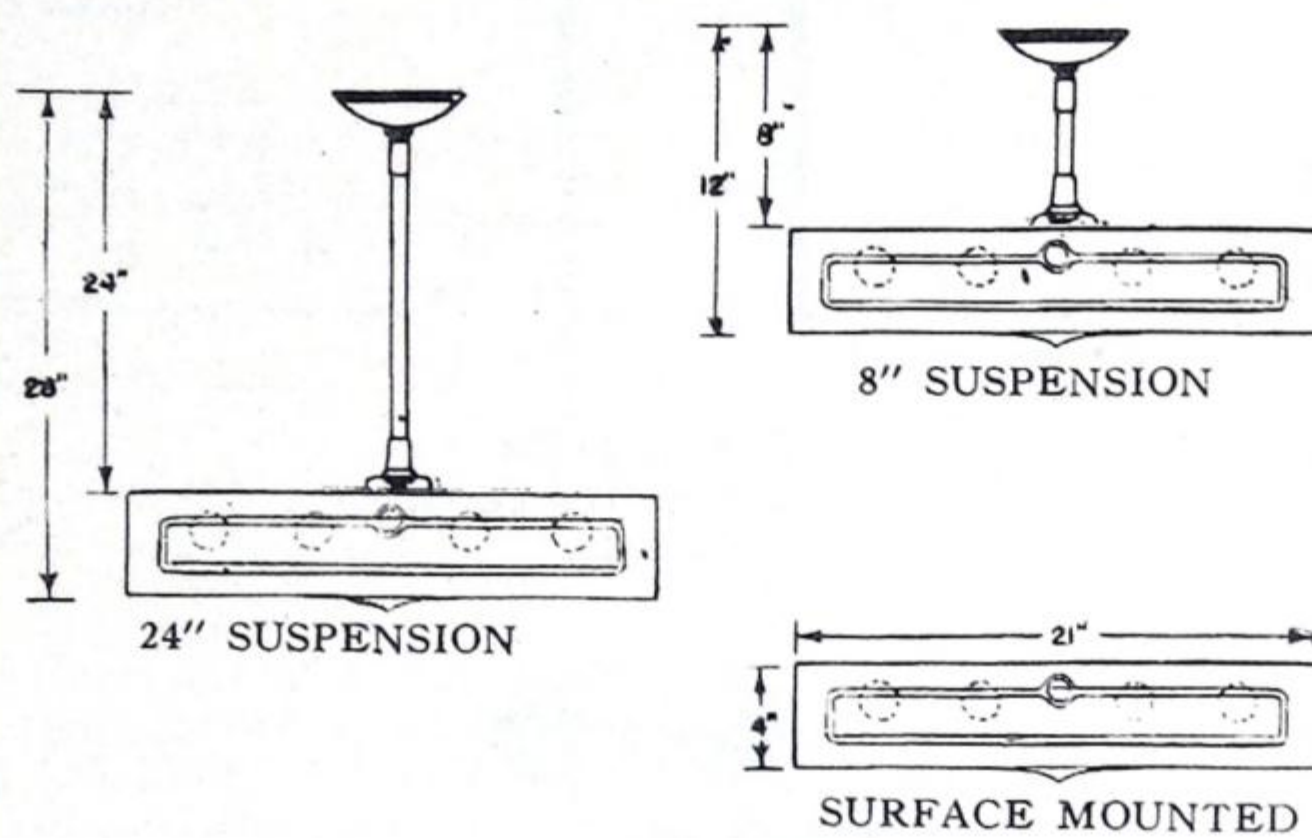

SHIELDING LENGTHWISE 19° ANGLE CROSSWISE 30°	
SPACING 1.2xMH	EFF 81.5%
M.F. "PLEXOLINE-4"	42.5%
G.75 97403	39.0%
M.70 SUSPENSION	
P.65	
CEILING	75% 50%
WALLS	50% 30% 10% 50% 30% 10%
ROOM INDEX	COEFFICIENT OF UTILISATION
J	.29 .25 .23 .26 .23 .21
I	.35 .32 .30 .32 .29 .27
H	.40 .36 .33 .35 .32 .29
G	.43 .40 .37 .38 .35 .33
F	.46 .43 .40 .40 .37 .36
E	.50 .47 .44 .44 .41 .39
D	.54 .50 .48 .47 .44 .42
C	.56 .53 .50 .49 .46 .44
B	.59 .56 .54 .51 .49 .47
A	.60 .58 .56 .53 .50 .48

"Plexoline-4" For 48" T12 Slimline Lamps†

Description	Catalogue No.	Lamps	Volts	Cycles	m.a.	Overall Length
For Surface Mounting*	47400	4 x 48" T12	118	60	430	48 7/8"
For Suspension Mounting	47403	4 x 48" T12	118	60	430	48 7/8"

*Surface Mounting unit is equipped with reflector plates.

†In addition to being mounted singly these units may be used on the end of a row of 8' units.

"Plexoline-4" For 96" T12 Slimline Lamps

Description	Catalogue No.	Lamps	Volts	Cycles	m.a.	Overall Length
For Surface Mounting*	97400	4 x 96" T12	118	60	430	96 7/8"
For Suspension Mounting	97403	4 x 96" T12	118	60	430	96 7/8"

*Surface Mounting unit is equipped with reflector.

Hanger Cat. Nos.

Description	Double Stem Adjustable 24"†*	Single Stem Adjustable 8"***	Single Stem Adjustable 24"***
Metallic Grey	9925	7789	7719
White Enamel	9925W	7789W	7719W

*Special length hangers will be supplied if specified.

†Recommended for 4' unit only.

SLIMLINE SHIELDED UNITS

Day-Brite "Plexoline-4" Slimline Units

Hangers

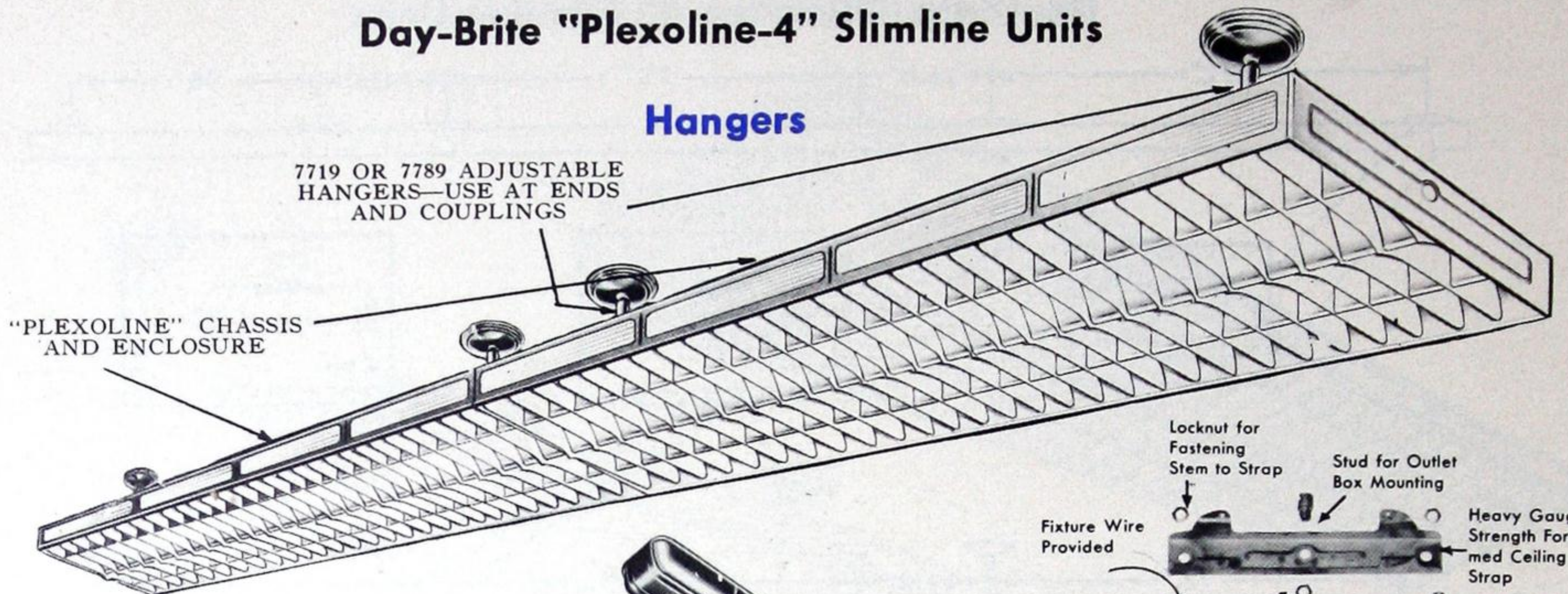

No. 7789—8"



No. 7719—24"

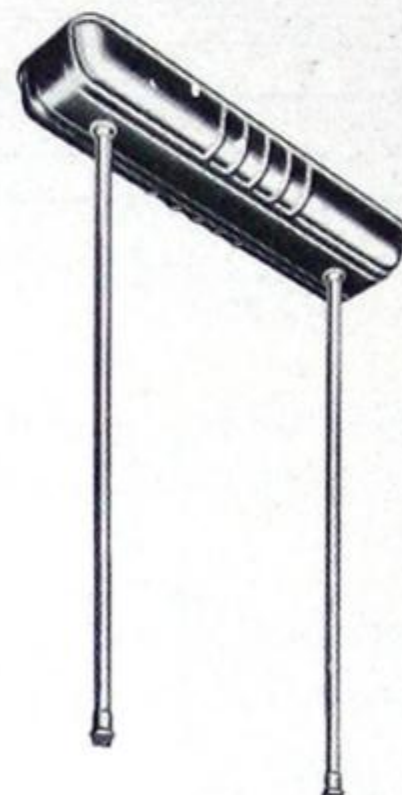

DOUBLE STEM
24" HANGER—STANDARD
No. 9925



No. 9999-A—
STUD MOUNTING STRAP
For mounting and connecting
chassis with outlet box at
chassis coupling.

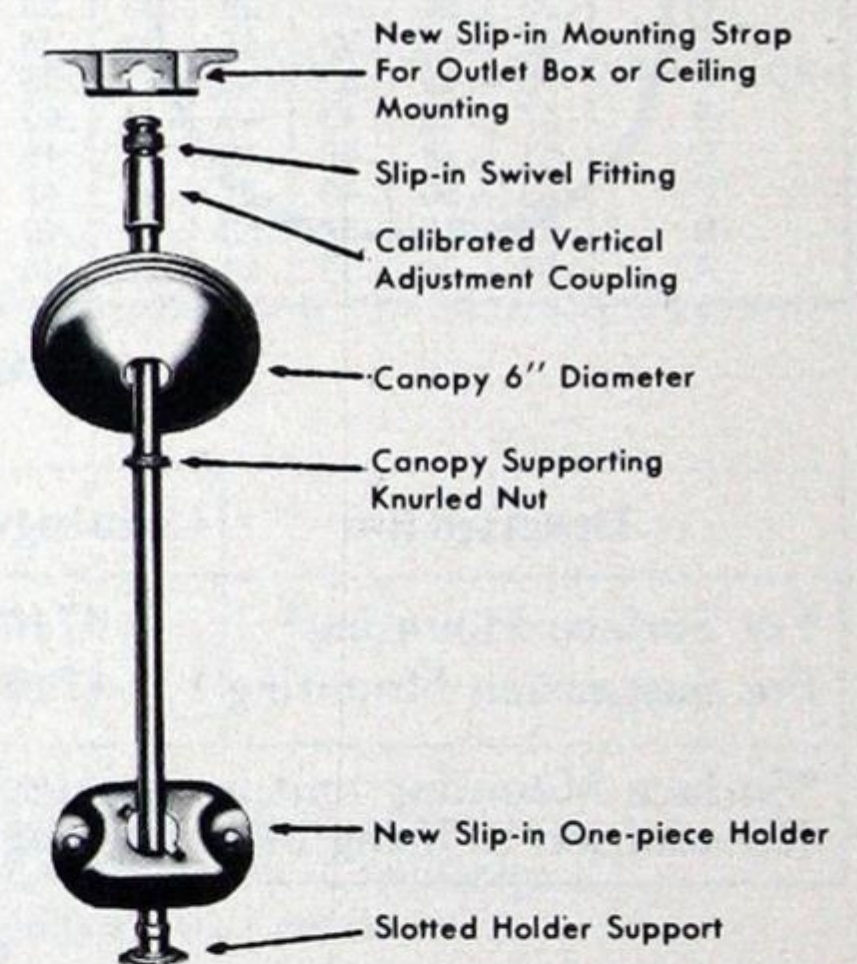
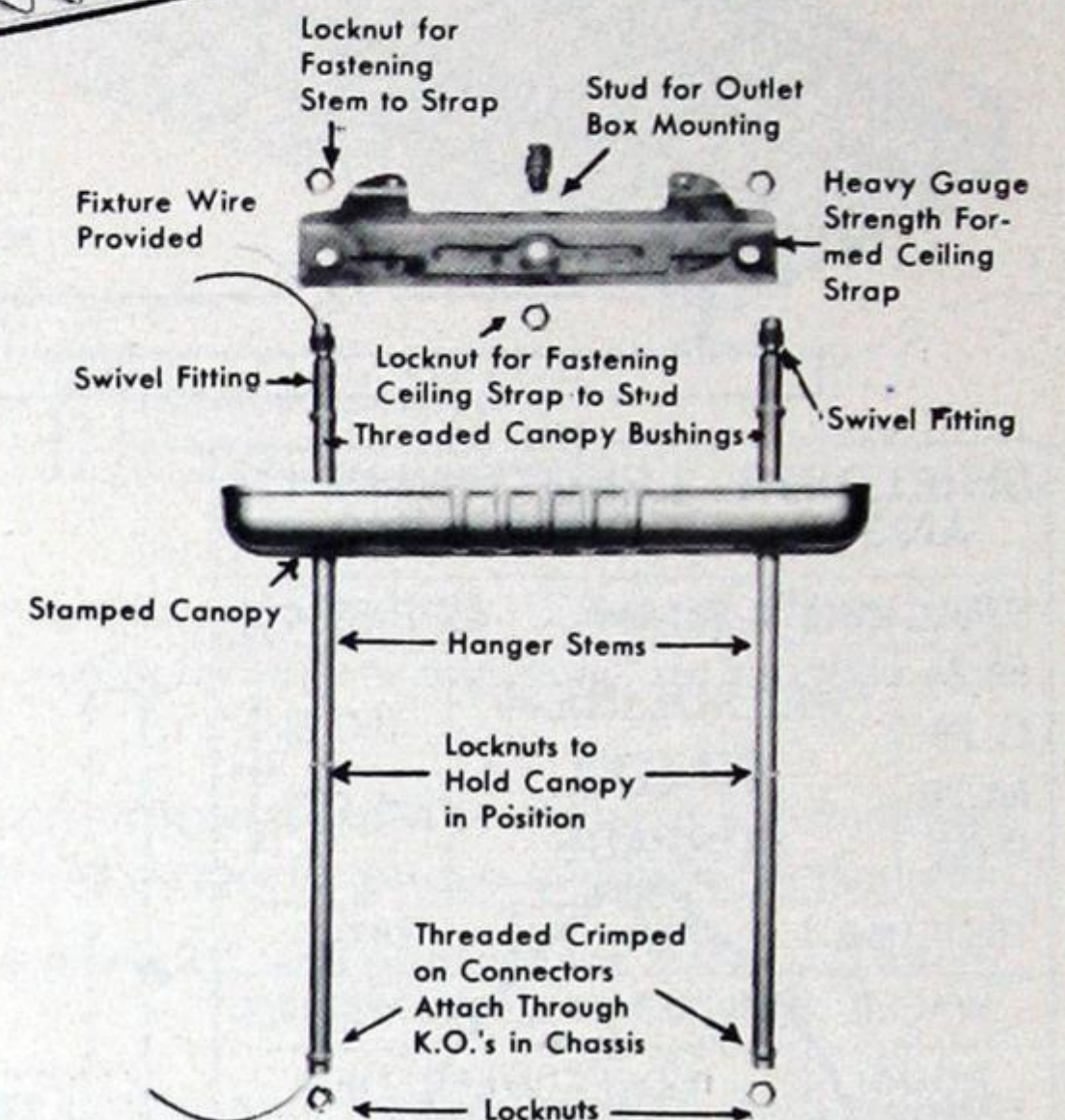

V-shaped longitudinal louvers provide additional light output in useful area of illumination, and provide maximum strength and rigidity.

Louver assembly is attached to chassis by easily accessible snap catches. No tools required.

Center wireway cover, lateral and longitudinal louvers, and side rail completely interlocked for maximum strength.

Entire assembly finished in baked Super-White enamel.

Steel frame die formed and welded construction for added strength.

For easy maintenance assembly is supported by service chains. May be unhooked for complete removal.



FLUORESCENT AND SLIMLINE SHIELDED UNITS
Electrolier "Neptune" Units

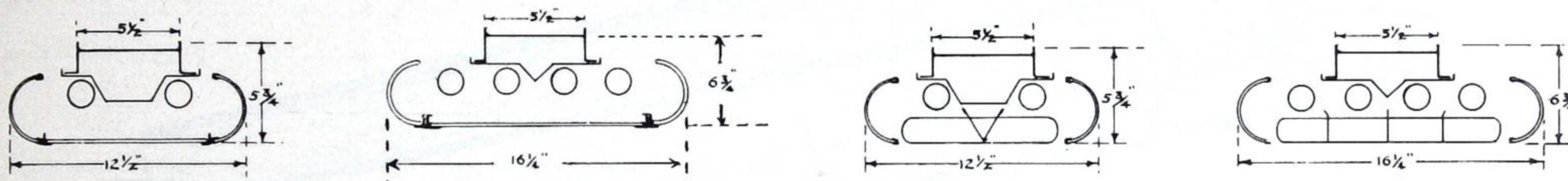
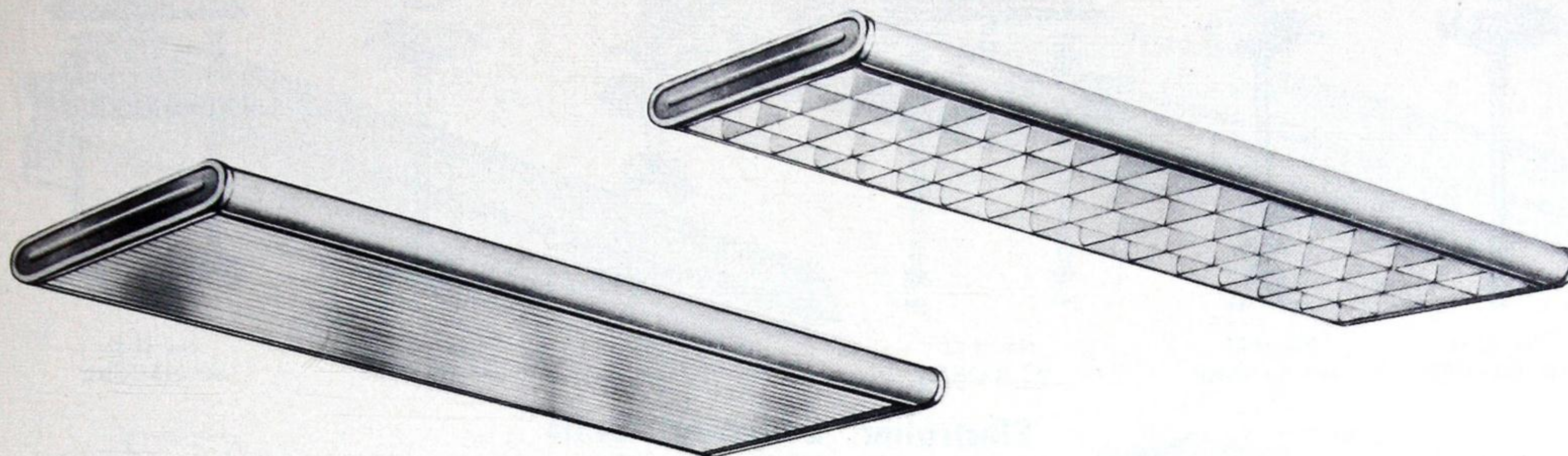

SHIELDING ANGLE		LENGTHWISE 23°		CROSSWISE 35°		
SPACING 1.0xMH		EFF 65.0%				
M.F.	"NEPTUNE" KP-882-48 LOUVERED	15.9%				
G.70		49.1%				
M.65						
P.60						
CEILING	75%		50%			
WALLS	50%	30%	10%	50%	30%	10%
ROOM INDEX	COEFFICIENT OF UTILISATION					
J	.29	.27	.25	.27	.26	.24
I	.35	.32	.31	.33	.31	.30
H	.38	.36	.35	.36	.34	.33
G	.41	.39	.38	.39	.37	.36
F	.43	.41	.39	.40	.39	.37
E	.46	.44	.43	.44	.42	.40
D	.49	.46	.45	.46	.44	.43
C	.50	.48	.46	.47	.45	.44
B	.52	.50	.48	.49	.47	.46
A	.53	.52	.49	.50	.48	.47

Complete units for suspension or surface mounting, as single units or in continuous rows.
CONSTRUCTION—All units are equipped with plastic side panels, and are available with either hinged metal louvers or hinged Albalite glass panels.
MOUNTING—Chassis is arranged for either surface or suspension mounting. When mounting in continuous rows on hangers use No. H-11 hangers on ends of rows, and No. H-21 hangers at junctions. Use No. H-11 single stem, or No. H-22 double stem hangers for mounting individual units. See next page for illustrations of hangers.
FINISH—All metal parts finished in baked white enamel.
WIRING—40W units are supplied with best quality fully compensated 2 x 40W ballasts. Standard starters are supplied. Automatic or manual reset starters will be furnished if specified. Slimline or instant start units may be supplied with either standard or "Series-Sequence" type ballasts.

SHIELDING ANGLE		LENGTHWISE 23°		CROSSWISE 35°		
SPACING 1.0xMH		EFF 65.1%				
M.F.	"NEPTUNE" KP-884-48 LOUVERED	23.5%				
G.70		41.6%				
M.65						
P.60						
CEILING	75%		50%			
WALLS	50%	30%	10%	50%	30%	10%
ROOM INDEX	COEFFICIENT OF UTILISATION					
J	.26	.24	.21	.25	.23	.21
I	.32	.30	.28	.30	.28	.27
H	.35	.33	.32	.33	.31	.30
G	.38	.36	.34	.36	.34	.32
F	.40	.38	.36	.37	.36	.34
E	.43	.41	.39	.40	.38	.37
D	.47	.44	.42	.43	.41	.39
C	.48	.46	.43	.44	.43	.41
B	.50	.48	.46	.46	.44	.43
A	.51	.49	.47	.47	.45	.44

Catalogue No.	Description	Lamps	Dimensions		
			Length	Depth	Width
KP-882-48†	"Neptune"—Louvered	2x40W	49 3/4"	5 3/4"	12 1/2"
KP-884-48†	"Neptune"—Louvered	4x40W	49 3/4"	6 3/4"	16 1/4"
SLP-882-48	Slimline "Neptune"—Louvered	2x48" T12	49 3/4"	5 3/4"	12 1/2"
SLP-884-48	Slimline "Neptune"—Louvered	4x48" T12	49 3/4"	6 3/4"	16 1/4"
SLP-882-96*	Slimline "Neptune"—Louvered	2x96" T8 or T12	96 1/4"	5 3/4"	12 1/2"
SLP-884-96*	Slimline "Neptune"—Louvered	2x96" T8 or T12	96 1/4"	6 3/4"	16 1/4"

*Specify for use with T8 or T12 lamps; if for use with T8 lamp, state also whether for 200 or 300 ma operation. Units for use with T12 lamp will be supplied for 430 ma operation.
 †For instant start operation add suffix "IS" to Catalogue No.



FLUORESCENT SHIELDED UNITS

Electrolier Hangers

STANDARD HANGERS

CLAMP TYPE HANGERS

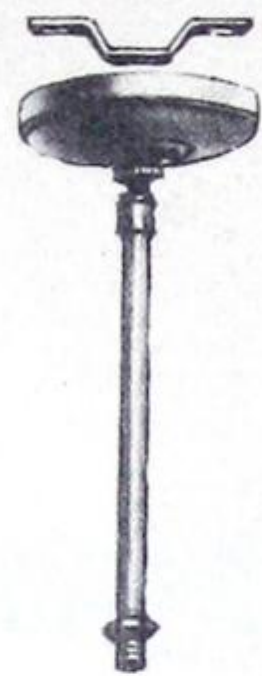

No. H-11
24" HANGER



No. H-21
24" HANGER

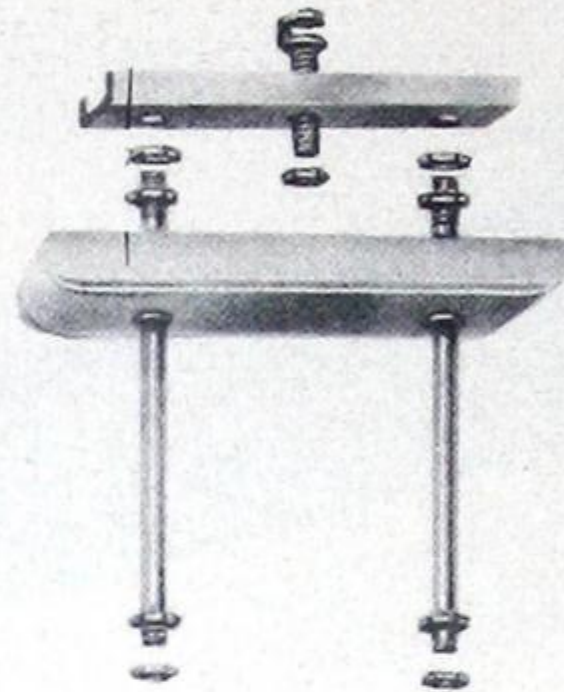

No. H-22
24" HANGER

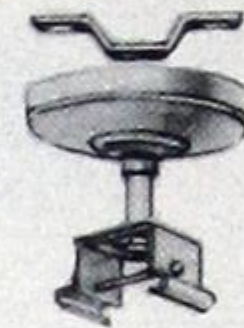

No. H-41
4" HANGER

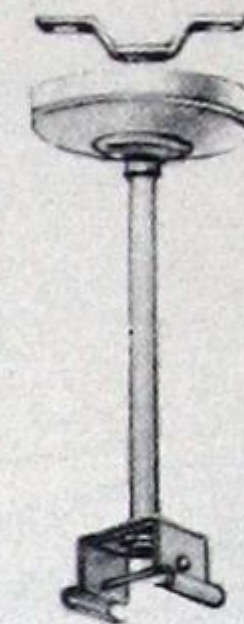

No. H-31
24" HANGER

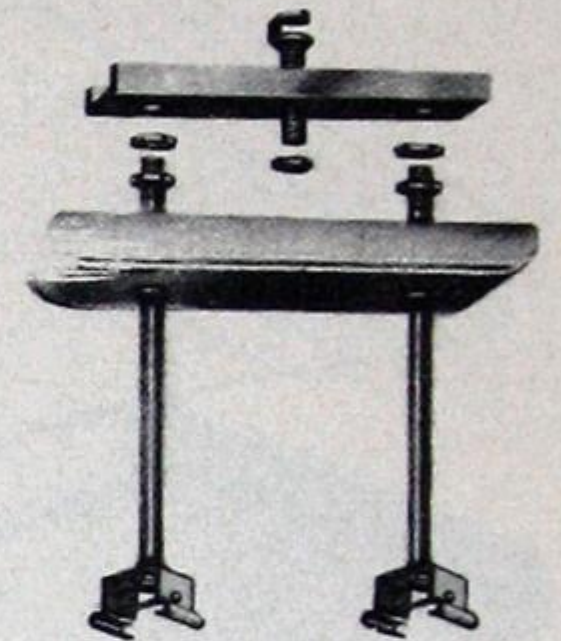

No. H-42
24" HANGER

Electrolier "Educator" Units

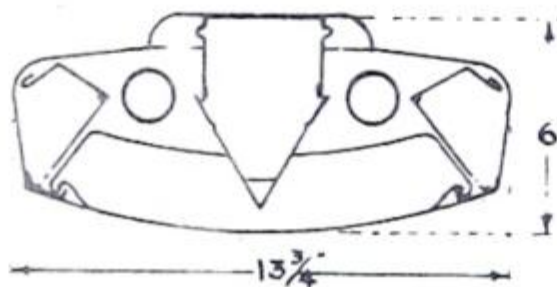
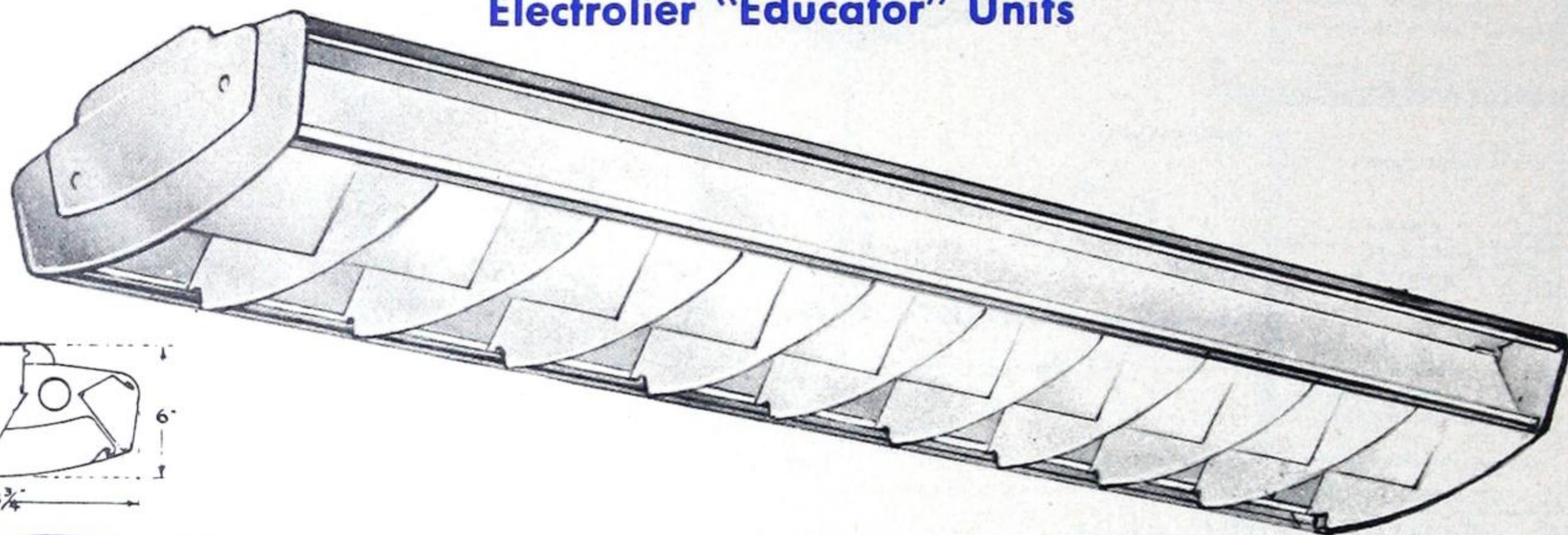

SHIELDING LENGTHWISE 33°		ANGLE CROSSWISE 40°	
SPACING 1.1xMH		EFF 78.4%	
M.F.	"EDUCATOR"	40.0% ↑	
G.70	K-512-48	38.4% ↓	
M.65			
P.60			
CEILING	75%	50%	
WALLS	50%	30%	10%
ROOM INDEX	COEFFICIENT OF UTILISATION		
J	.28	.25	.23
I	.34	.31	.30
H	.37	.35	.33
G	.41	.39	.36
F	.42	.40	.38
E	.47	.44	.43
D	.50	.47	.45
C	.52	.50	.47
B	.55	.52	.50
A	.56	.54	.52

Complete units recommended for suspension mounting as individual units or in continuous rows.

CONSTRUCTION—Units are provided with hinged and removable metal louvers for ease of servicing, and metal side panels.

MOUNTING—Recommended for suspension mounting using No. H-31 single stem or No. H-42 double stem clamp type hangers, or No. H-41 close-to ceiling-clamp type canopy.

FINISH—All metal parts finished in baked white enamel.

WIRING—Cat. No. K-512-48 is supplied with best quality fully compensated 2 x 40W ballast.

Cat. No. K-512-24 is available with either Low Power Factor or High Power Factor ballast.

Catalogue No.	Description	Lamps	Dimensions		
			Length	Depth	Width
K-512-48*	"Educator"	2 x 40W	49 1/4"	6"	13 3/4"

*For Instant Start, operation add suffix "IS" to Catalogue No. Available with Standard or "Series-Sequence" ballast.



FLUORESCENT AND SLIMLINE SHIELDED UNITS

Electrolier "Astralite" Units

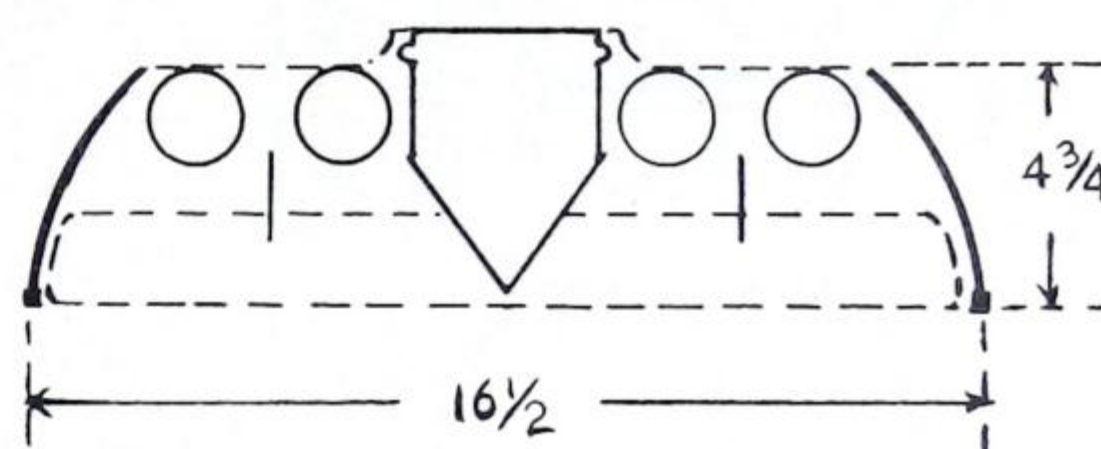
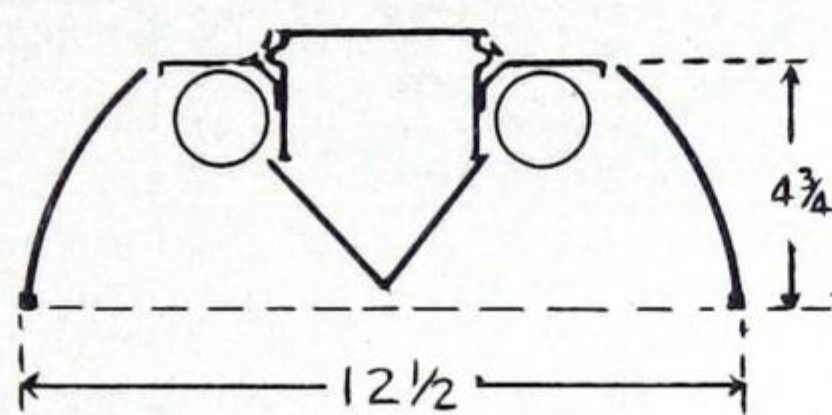
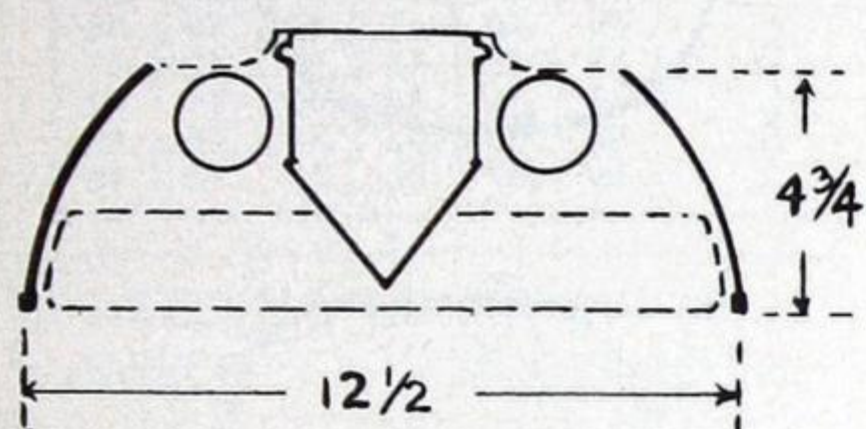
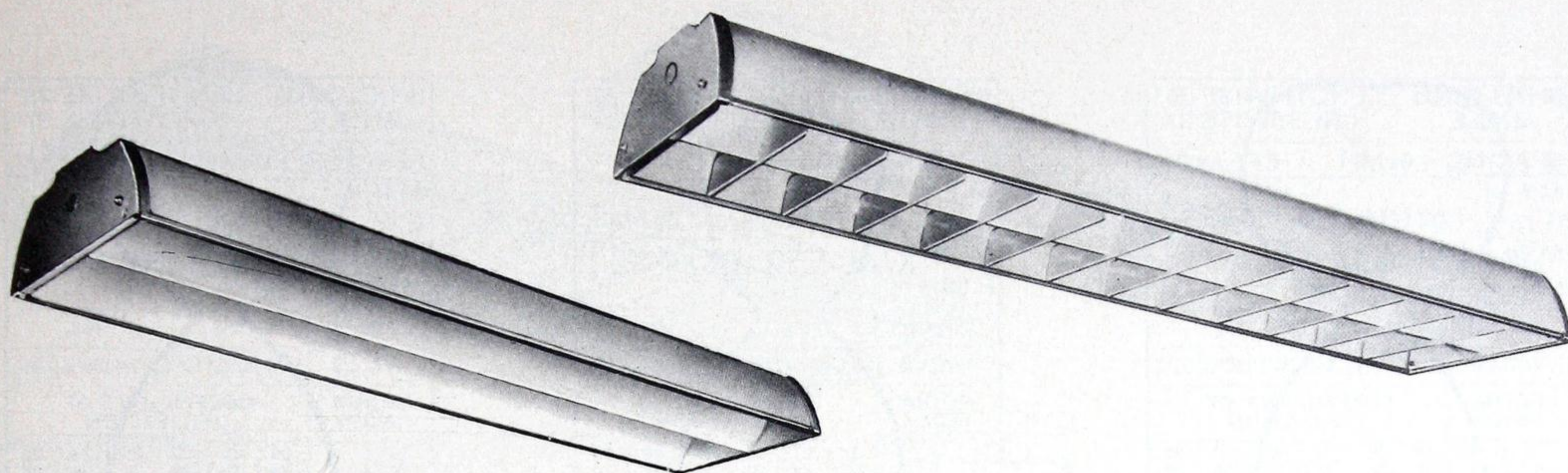

Complete 2 lamp and 4 lamp 20 watt and 40 watt units. Available with or without louvers, for suspension or surface mounting, as individual units or in continuous rows.

CONSTRUCTION—The choice of open or louvered units with glass, plastic or metal side panels is offered. Where fixtures are to be surface mounted, top reflector plates should be specified. On shielded units louvers may be hinged down from either side or removed completely for ease of servicing.

MOUNTING—No. H-41 Close ceiling (4") clamp type canopy or Nos. H-31 single stem or H-42 double stem (24") clamp type hangers may be used for individual or continuous mounting. No. H-22 double stem rod hanger may also be used.

FINISH—All metal parts are finished in baked white enamel.

WIRING—40W units are supplied with best quality fully compensated 2 x 40W ballasts. 20W units are available with either Low Power Factor or High Power Factor ballasts. Standard starters are supplied. Automatic or manual reset starters will be furnished if specified. Slimline and Instant Start units may be supplied with either standard or "Series-Sequence" type ballasts.

SHIELDING LENGTHWISE 0° ANGLE CROSSWISE 35°	
SPACING 1.0xMH EFF 68.0%	
M.F.	"ASTRALITE"*
G.75	KG-552-48 7.0% ↑
M.70	KP-552-48 61.0% ↓
P.65	
CEILING	75% 50%
WALLS	50% 30% 10% 50% 30% 10%
ROOM INDEX	COEFFICIENT OF UTILISATION
J	.34 .33 .32 .33 .32 .31
I	.41 .39 .38 .39 .38 .37
H	.44 .43 .42 .43 .42 .41
G	.48 .47 .46 .46 .45 .44
F	.51 .48 .47 .48 .47 .46
E	.54 .53 .52 .53 .51 .49
D	.57 .55 .53 .54 .52 .51
C	.58 .56 .54 .55 .53 .52
B	.60 .59 .57 .57 .55 .54
A	.61 .60 .58 .58 .57 .56

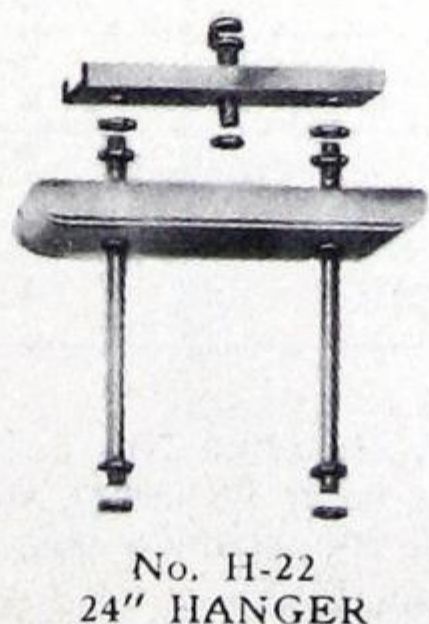

SHIELDING LENGTHWISE 25° ANGLE CROSSWISE 38°	
SPACING 1.0xMH EFF 82.0%	
M.F.	"ASTRALITE" 43.5% ↑
G.75	KGL-552-48 38.5% ↓
M.70	
P.65	
CEILING	75% 50%
WALLS	50% 30% 10% 50% 30% 10%
ROOM INDEX	COEFFICIENT OF UTILISATION
J	.29 .25 .24 .25 .23 .22
I	.35 .32 .30 .31 .29 .27
H	.39 .36 .34 .34 .32 .30
G	.42 .40 .37 .37 .35 .33
F	.45 .42 .39 .39 .37 .35
E	.49 .46 .44 .43 .40 .38
D	.53 .49 .47 .45 .43 .41
C	.55 .52 .49 .47 .44 .42
B	.58 .55 .52 .49 .47 .45
A	.59 .57 .55 .51 .48 .47

*With K-52-48 Reflector Plates.



FLUORESCENT AND SLIMLINE SHIELDED UNITS

Electrolier "Astralite" Units

SHIELDING LENGTHWISE 25° ANGLE CROSSWISE 37°	
SPACING 1.0xMH	EFF 82.0%
M.F.	"ASTRALITE" 46.0% ↑
G.75	KGL-554-48 36.0% ↓
M.70	
P.65	
CEILING	75% 50%
WALLS	50% 30% 10% 50% 30% 10%
ROOM INDEX	COEFFICIENT OF UTILISATION
J	.29 .25 .23 .25 .23 .21
I	.35 .32 .30 .31 .28 .27
H	.39 .36 .34 .34 .32 .30
G	.42 .39 .38 .37 .35 .33
F	.45 .42 .40 .39 .37 .35
E	.49 .46 .44 .43 .40 .38
D	.53 .49 .47 .45 .43 .41
C	.55 .52 .49 .47 .45 .43
B	.58 .55 .53 .49 .47 .45
A	.59 .57 .55 .51 .48 .47

SHIELDING LENGTHWISE 25° ANGLE CROSSWISE 37°	
SPACING 1.0xMH	EFF 78.0%
M.F.	"ASTRALITE" 36.5% ↑
G.75	KML-552-48 41.5% ↓
M.70	
P.65	
CEILING	75% 50%
WALLS	50% 30% 10% 50% 30% 10%
ROOM INDEX	COEFFICIENT OF UTILISATION
J	.31 .27 .26 .27 .26 .24
I	.36 .34 .32 .33 .31 .30
H	.40 .38 .37 .36 .34 .34
G	.44 .42 .39 .39 .37 .36
F	.47 .44 .41 .41 .39 .38
E	.50 .47 .45 .44 .42 .41
D	.54 .50 .48 .47 .45 .43
C	.55 .53 .50 .48 .46 .45
B	.58 .55 .53 .50 .48 .47
A	.59 .57 .55 .52 .50 .48

SHIELDING LENGTHWISE 25° ANGLE CROSSWISE 37°	
SPACING 1.0xMH	EFF 81.5%
M.F.	"ASTRALITE" 44.5% ↑
G.75	KML-554-48 37.0% ↓
M.70	
P.65	
CEILING	75% 50%
WALLS	50% 30% 10% 50% 30% 10%
ROOM INDEX	COEFFICIENT OF UTILISATION
J	.29 .25 .24 .25 .23 .22
I	.35 .32 .30 .31 .28 .27
H	.39 .36 .34 .34 .32 .30
G	.42 .40 .37 .37 .34 .33
F	.45 .42 .39 .39 .36 .35
E	.49 .46 .43 .42 .40 .38
D	.53 .49 .46 .45 .42 .41
C	.55 .51 .48 .46 .44 .42
B	.58 .55 .52 .48 .46 .45
A	.59 .57 .55 .50 .48 .46

"Astralite" Units—Glass Side Panels

Catalogue No.	Description	Lamps	Reflector Plates*	Overall Length
KG-552-24	Open Unit	2 x 20W	1 Pr. K-52-24	24 1/4"
KG-552-48†	Open Unit	2 x 40W	1 Pr. K-52-48	48 1/4"
KGL-552-24	Louvered Unit	2 x 20W	1 Pr. K-52-24	24 1/4"
KGL-552-48†	Louvered Unit	2 x 40W	1 Pr. K-52-48	48 1/4"
KGL-554-24	Louvered Unit	4 x 20W	1 Pr. K-54-24	24 1/4"
KGL-554-48†	Louvered Unit	4 x 40W	1 Pr. K-54-48	48 1/4"
SLG-552-96	Slimline Louvered Unit**	2 x 96"	1 Pr. SL-52-96	96 1/4"
SLG-554-96	Slimline Louvered Unit**	4 x 96"	1 Pr. SL-54-96	96 1/4"

"Astralite" Units—Metal Side Panels

Catalogue No.	Description	Lamps	Reflector Plates*	Overall Length
KM-552-24	Open Unit	2 x 20W	1 Pr. K-52-24	24 1/4"
KM-552-48†	Open Unit	2 x 40W	1 Pr. K-52-48	48 1/4"
KML-552-24	Louvered Unit	2 x 20W	1 Pr. K-52-24	24 1/4"
KML-552-48†	Louvered Unit	2 x 40W	1 Pr. K-52-48	48 1/4"
KML-554-24	Louvered Unit	4 x 20W	1 Pr. K-54-24	24 1/4"
KML-554-48†	Louvered Unit	4 x 40W	1 Pr. K-54-48	48 1/4"
SLM-552-96	Slimline Louvered Unit**	2 x 96"	1 Pr. SL-52-96	96 1/4"
SLM-554-96	Slimline Louvered Unit**	4 x 96"	1 Pr. SL-54-96	96 1/4"

"Astralite" Units—Plastic Side Panels

Catalogue No.	Description	Lamps	Reflector Plates*	Overall Length
KP-552-24	Open Unit	2 x 20W	1 Pr. K-52-24	24 1/4"
KP-552-48†	Open Unit	2 x 40W	1 Pr. K-52-48	48 1/4"
KPL-552-24	Louvered Unit	2 x 20W	1 Pr. K-52-24	24 1/4"
KPL-552-48†	Louvered Unit	2 x 40W	1 Pr. K-52-48	48 1/4"
KPL-554-24	Louvered Unit	4 x 20W	1 Pr. K-54-24	24 1/4"
KPL-554-48†	Louvered Unit	4 x 40W	1 Pr. K-54-48	48 1/4"
SLP-552-96	Slimline Louvered Unit**	2 x 96"	1 Pr. SL-52-96	96 1/4"
SLP-554-96	Slimline Louvered Unit**	4 x 96"	1 Pr. SL-54-96	96 1/4"

*Specify separately, for surface mounted units.

†For Instant Start operation and suffix "IS" to Catalogue No.

**Specify for use with T8 or T12 lamps; if for use with T8 lamp, state also whether for 200 or 300 ma operation. Units for use with T12 lamps will be supplied for 430 ma operation.

Note: 45° x 45° Shielding can be supplied if specified.



FLUORESCENT AND SLIMLINE SHIELDED AND OPEN TYPE UNITS

Electrolier "Pacemaker" and "Horizon" Units

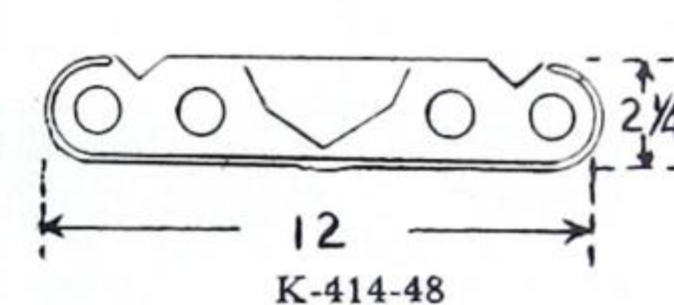
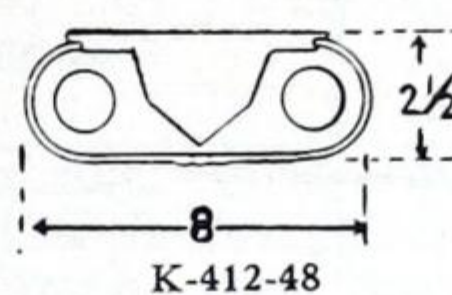
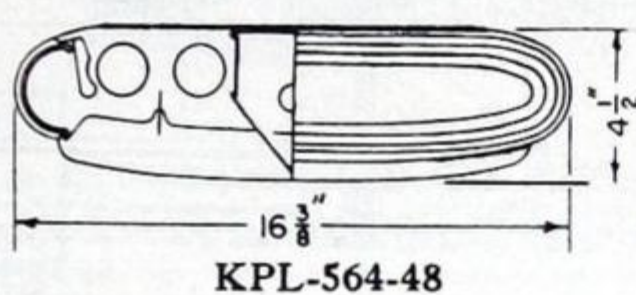
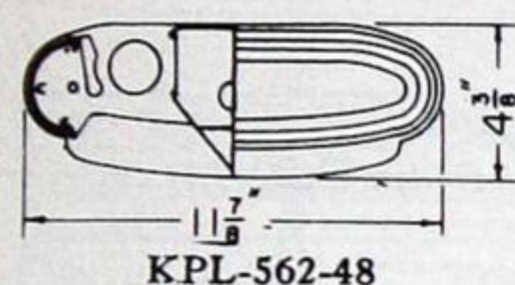
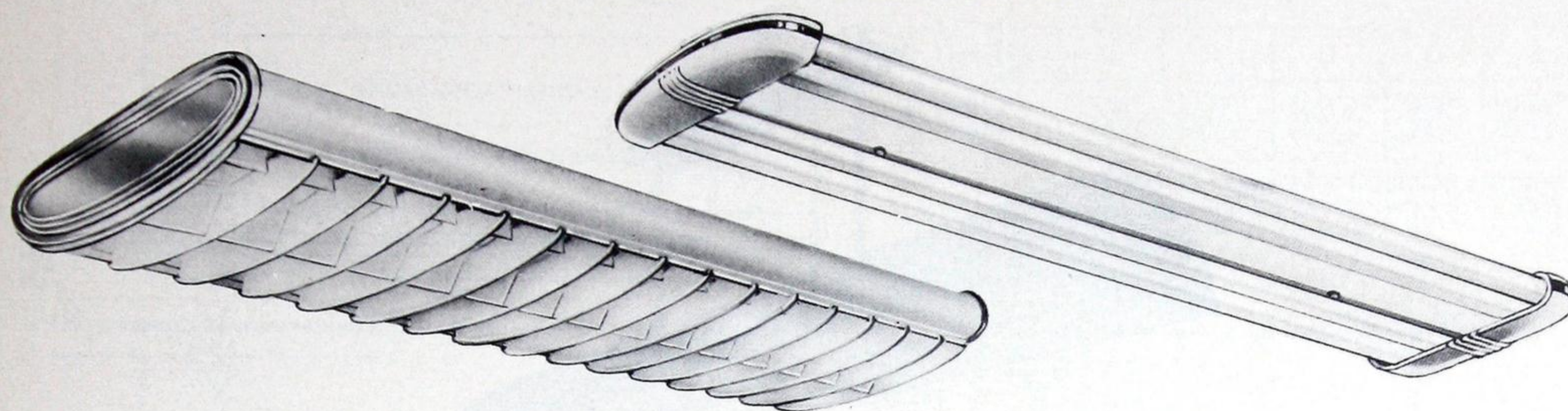

"Pacemaker"

Complete units for suspension or surface mounting, as individual units or in continuous rows.
CONSTRUCTION—The Pacemaker comes complete with metal louver secured by clips which may be lowered on chains for servicing. The translucent removable plastic side panels are engaged by each of the transverse louvers assuring rigidity and permanent positioning.
MOUNTING—No. H-41 close ceiling (4") clamp type canopy or No. H-31 single stem or H-42 double stem (24") clamp type hangers may be used for individual or continuous mounting. No. H-22 double stem rod hanger may also be used. For hanger illustrations see previous pages.
FINISH—All metal parts are finished in baked white enamel.
WIRING—40W units are supplied with best quality fully compensated 2 x 40W ballasts. 20W units are available with either Low Power Factor or High Power Factor ballasts. Standard starters are supplied. Automatic or manual reset starters will be furnished if specified. Slimline and Instant Start units may be supplied with either standard or "Series-Sequence" type ballasts.

SHIELDING LENGTHWISE 25°		ANGLE CROSSWISE 35°	
SPACING 0.9xMH		EFF 85.5%	
M.F.	"PACEMAKER"	47.0%	
G.75	KPL-562-48	38.5%	
M.70			
P.65			
CEILING	75%	50%	
WALLS	50%	30%	10%
ROOM INDEX	COEFFICIENT OF UTILISATION		
J	.29	.25	.24
I	.35	.32	.30
H	.39	.36	.34
G	.42	.40	.37
F	.45	.42	.39
E	.49	.46	.44
D	.53	.49	.47
C	.55	.52	.49
B	.58	.55	.52
A	.59	.57	.55

SHIELDING LENGTHWISE 25°		ANGLE CROSSWISE 35°	
SPACING 0.9xMH		EFF 85.0%	
M.F.	"PACEMAKER"	50.0%	
G.75	KPL-564-48	35.0%	
M.70			
P.65			
CEILING	75%	50%	
WALLS	50%	30%	10%
ROOM INDEX	COEFFICIENT OF UTILISATION		
J	.29	.25	.23
I	.35	.32	.30
H	.39	.36	.34
G	.42	.39	.37
F	.45	.42	.39
E	.49	.46	.44
D	.53	.49	.47
C	.55	.52	.49
B	.58	.55	.53
A	.59	.57	.55

Catalogue No.	Description	Lamps	Overall Length
KPL-562-48*	"Pacemaker"	2 x 40W	49 3/4"
KPL-564-48*	"Pacemaker"	4 x 40W	49 3/4"
SLP-562-48†	Slimline "Pacemaker"	2 x 48"	48 7/8"
SLP-562-96†	Slimline "Pacemaker"	2 x 96"	98 1/2"
SLP-564-48†	Slimline "Pacemaker"	4 x 48"	48 7/8"
SLP-564-96†	Slimline "Pacemaker"	4 x 96"	98 1/2"

"Horizon"

Complete open type two and four lamp units with moulded translucent white glass ends with chrome trim. Recommended for surface mounting as individual units or in continuous rows. When ordering for continuous mounting state quantity of fixtures in each row, so that correct number of ends and joining straps will be furnished. Finished in baked white enamel. 40W units are supplied with highest quality fully compensated 2 x 40W ballasts. 20W units are available with Low Power Factor or High Power Factor ballasts. Slimline units may be supplied with either standard or "Series Sequence" type ballasts.

Catalogue No.	Description	Lamps	Dimensions		
			Length	Depth	Width
K-412-48*	"Horizon"	4 x 20W	50"	2 1/2"	8"
K-414-48*	"Horizon"	4 x 40W	50"	2 1/2"	12"
SL-412-96†	Slimline "Horizon"	2 x 96"	99 1/2"	5 3/4"	8"
SL-414-96†	Slimline "Horizon"	4 x 96"	99 1/2"	5 3/4"	12"

*For Instant Start Operation add "IS" to Catalogue No.

†Specify for use with T8 or T12 lamps; if for use with T8 lamp, state also whether for 200 or 300 ma operation. Units for use with T12 lamps will be supplied for 430 ma operation.



FLUORESCENT SHIELDED UNITS

Curtis "Forty-Sixty" and "Forty-Sixty-One" Units

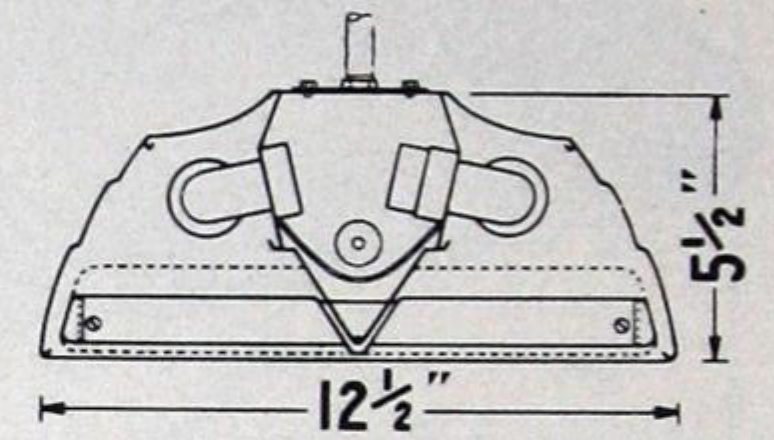
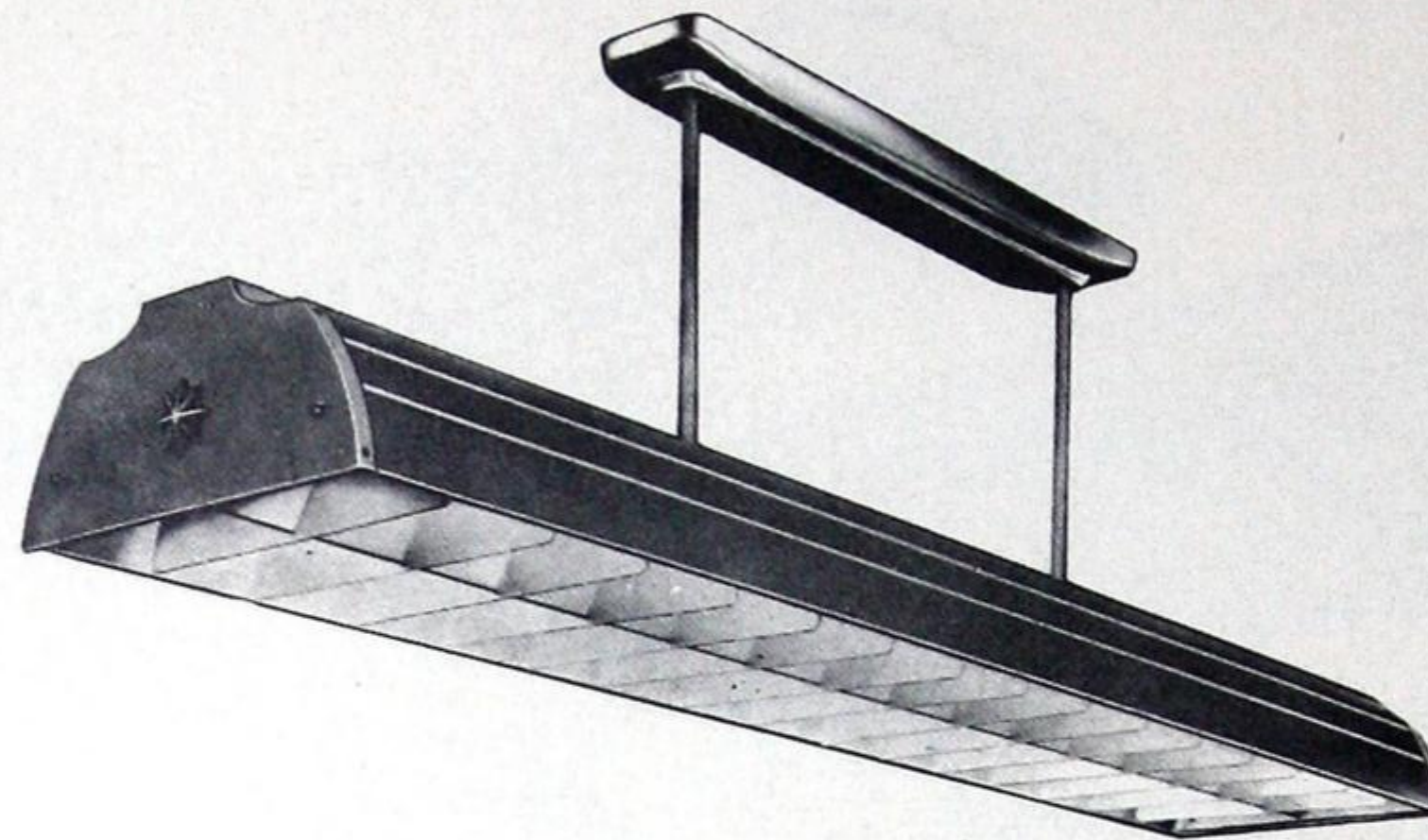

SHIELDING LENGTHWISE 25° ANGLE CROSSWISE 35°		EFF 75.7%				
SPACING 1xMH						
M.F.	FLURACITE "4060" WHITE	33.7%				
G.75		42.0%				
M.65						
P.50						
CEILING	75%		50%			
WALLS	50%	30%	10%	50%	30%	10%
ROOM INDEX	COEFFICIENT OF UTILISATION					
J	.30	.27	.26	.28	.26	.25
I	.36	.34	.33	.33	.32	.31
H	.40	.38	.36	.36	.35	.33
G	.43	.41	.39	.40	.37	.36
F	.46	.43	.41	.41	.39	.38
E	.49	.47	.45	.44	.42	.41
D	.52	.49	.47	.46	.45	.43
C	.54	.51	.49	.47	.46	.44
B	.56	.53	.52	.50	.48	.47
A	.57	.55	.53	.51	.49	.48

"Forty-Sixty" units for 2 x 40W lamps are designed to provide excellent, well shielded, general illumination for schools, offices, stores, etc.

"Forty-Sixty-One" units for 2 x 85W 60" lamps are designed to provide higher levels of well shielded general illumination for drafting rooms, sewing rooms and similar interiors where critical seeing tasks are performed.

All luminaires equipped with hinged louver that swings down for cleaning, re-lamping, replacement of starters or access to wiring channel.

Hangers illustrated on the following page.

Luminaires regularly supplied wired for 110-125 volt, 60 cycle AC circuits with best quality fully compensated ballasts and automatic re-set starters. Units are also available for Instant Start or 25 cycle operation if specified.

SHIELDING LENGTHWISE 25° ANGLE CROSSWISE 35°		EFF 79.1%				
SPACING 1xMH						
M.F.	ALZAK "4060A" ALUMINUM	32.2%				
G.75		46.9%				
M.65						
P.55						
CEILING	75%		50%			
WALLS	50%	30%	10%	50%	30%	10%
ROOM INDEX	COEFFICIENT OF UTILISATION					
J	.32	.28	.27	.29	.27	.25
I	.37	.36	.34	.36	.33	.32
H	.43	.40	.38	.39	.36	.35
G	.46	.44	.42	.42	.40	.38
F	.49	.47	.44	.44	.42	.40
E	.53	.51	.48	.48	.45	.44
D	.57	.53	.51	.50	.48	.47
C	.59	.56	.53	.52	.50	.48
B	.61	.58	.56	.54	.52	.51
A	.63	.60	.58	.56	.54	.52

"FLURACITE"*

Catalogue No.	Description	Lamps	Dimensions		
			Length	Depth	Width
4060-C	Unit with one No. 631 hanger	2x40W	48 3/4"	5 1/2"	12 1/2"
4060-CB	Basic unit with set of No. 629 hangers	2x40W	48 3/4"	5 1/2"	12 1/2"
4060-CE	Extension unit with one No. 630 hanger	2x40W	48 3/4"	5 1/2"	12 1/2"
4060-CLH	Unit less hanger	2x40W	48 3/4"	5 1/2"	12 1/2"
4061-C	Unit with one No. 628 hanger	2x85W	60 3/4"	5 1/2"	12 1/2"
4061-CB	Basic unit with set of No. 629 hangers	2x85W	60 3/4"	5 1/2"	12 1/2"
4061-CE	Extension unit with one No. 630 hanger	2x85W	60 3/4"	5 1/2"	12 1/2"
4061-CLH	Unit less hanger	2x85W	60 3/4"	5 1/2"	12 1/2"

*Finish—Reflectors, Wiring channel, end plates white "Fluracite". Louver "Alzak Aluminum".

"ALZAK ALUMINUM"†

Catalogue No.	Description	Lamps	Dimensions		
			Length	Depth	Width
4060-AC	Unit with one No. 631 hanger	2x40W	48 3/4"	5 1/2"	12 1/2"
4060-ACB	Basic unit with set of No. 629 hangers	2x40W	48 3/4"	5 1/2"	12 1/2"
4060-ACE	Extension unit with one No. 630 hanger	2x40W	48 3/4"	5 1/2"	12 1/2"
4060-ACLH	Unit less hanger	2x40W	48 3/4"	5 1/2"	12 1/2"
4061-AC	Unit with one No. 628 hanger	2x85W	60 3/4"	5 1/2"	12 1/2"
4061-ACB	Basic unit with set of No. 629 hangers	2x85W	60 3/4"	5 1/2"	12 1/2"
4061-ACE	Extension unit with one No. 630 hanger	2x85W	60 3/4"	5 1/2"	12 1/2"
4061-ACLH	Unit less hanger	2x85W	60 3/4"	5 1/2"	12 1/2"

†Finish—Reflectors and Louver "Alzak Aluminum" wiring channel "White Fluracite".



FLUORESCENT SHIELDED UNITS

Curtis Hangers and Installation Data

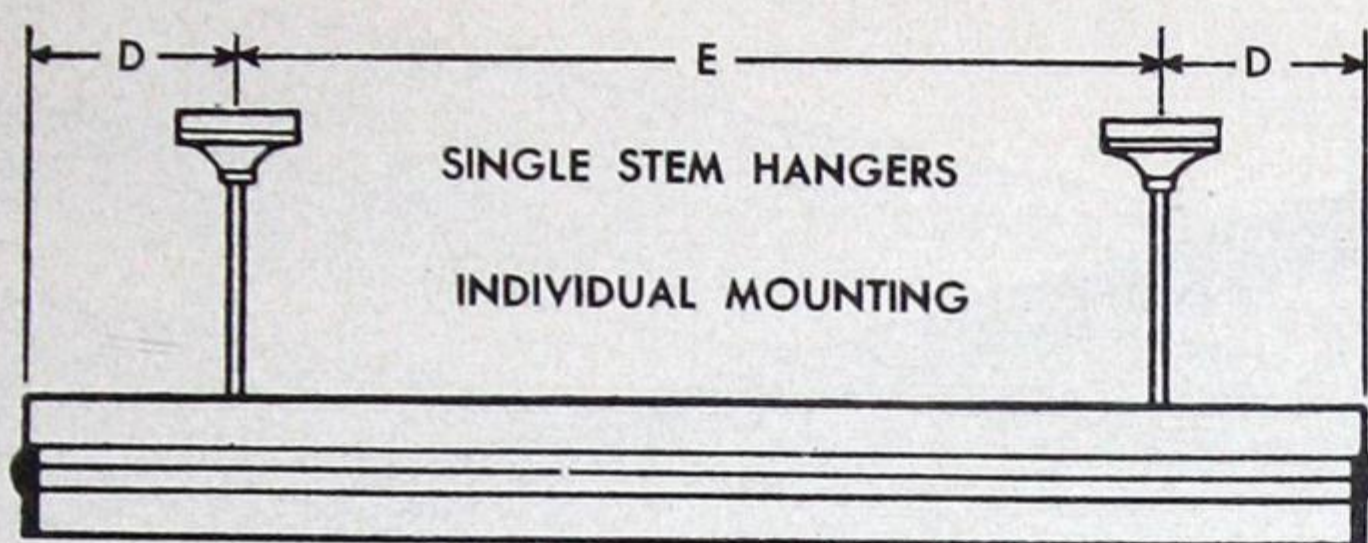

Cat. No.	A	B	C	D	E
4060	3 3/4"	44 7/16"	48 3/16"	3 3/4"	40 5/8"
4061	3 3/4"	56 7/16"	60 3/16"	3 3/4"	52 5/8"

When using double stem hangers for mounting continuous rows, the distance between hanger centers will be 48 3/16" for Cat. No. 4060 and 60 3/16" for 4061.

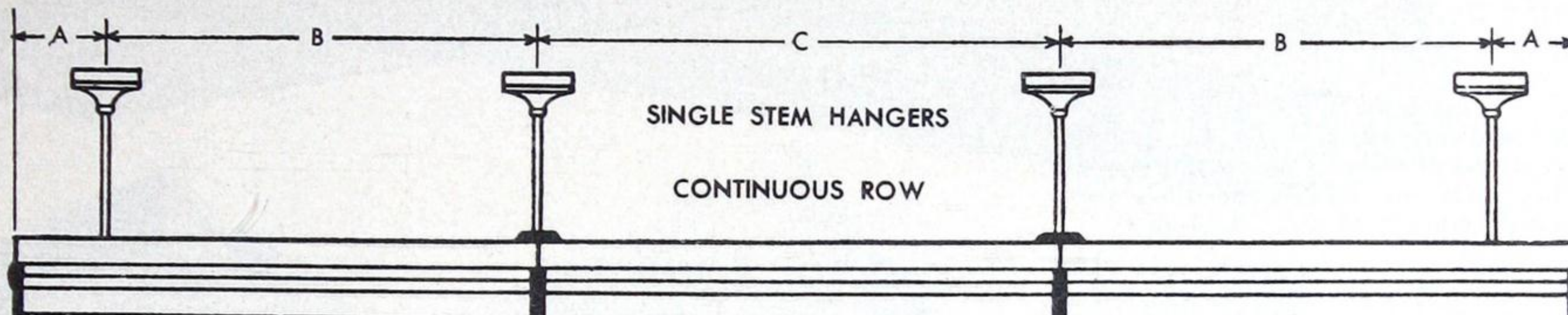

No. 631

CAT. No. 631—Two stem hanger for use with the "4060" luminaires is supplied with 12" stems spaced on 7 1/2" centers.

CAT. No. 628—Two stem hanger for use with the "4061" luminaires is supplied with 12" stems spaced on 21" centers.

Stems for both these hangers are also available in 18", 24", 36" and 48" lengths if specified. Two stem hangers are furnished complete with extension nipple, lock units and lead wires. Necessary connecting fittings for joining luminaires end to end are also supplied. Canopy and stems are finished grey.

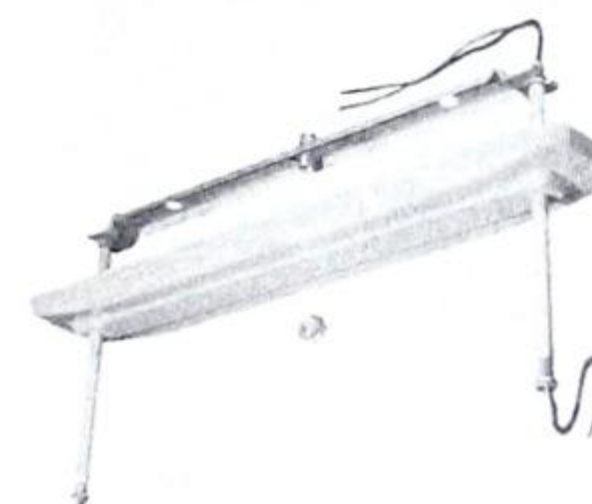

No. 628

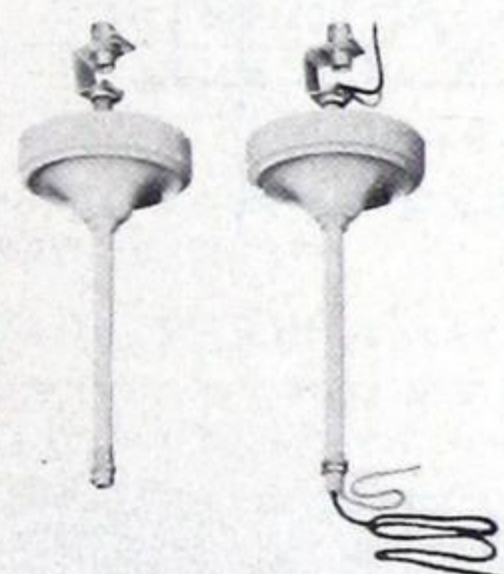

No. 629

CATALOGUE No. 629 (Set of 2 Hangers)—Single-stem hanger set for use with the "4060" and "4061" luminaires is regularly supplied with 12-inch stems. Stems are also available in 18-inch, 24-inch, 36-inch and 48-inch lengths if specified. Single-stem hanger sets are supplied complete with extension nipple, lock nuts and lead wires. Canopy and stems are finished grey.

When luminaires are to be suspended in continuous lines, order one set Catalogue No. 629 for each continuous line, and one Intermediate Hanger, Catalogue No. 630, wherever two luminaires are joined end to end.



No. 630

CATALOGUE No. 630—Intermediate Single-Stem Hanger for use with the "4060" and "4061" luminaires is regularly supplied in 12-inch lengths. Hanger is also available in 18-inch, 24-inch, 36-inch and 48-inch lengths if specified. Intermediate hanger is regularly supplied with hickey lock nuts. Necessary connecting fittings for joining luminaires end to end also supplied. Canopy and stems are finished grey.

When luminaires are to be suspended in continuous lines, order one set Catalogue No. 629 for each continuous line, and one Intermediate Hanger, Catalogue No. 630, where two luminaires are to be joined end to end.

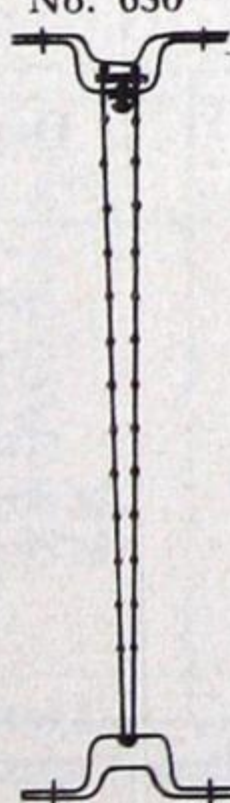

No. 680

CATALOGUE No. 680—The Slimwire Hanger is for use in joining fixtures of the "4060" and "4061" series in continuous lines. Wire entrance to be made through rod hangers. Order one set Catalogue No. 629 for ends, and one Slimwire Hanger, Catalogue No. 680, where two luminaires are to be joined end to end.

Slimwire Hanger comes in 36-inch lengths. If shorter lengths are required, wire can be cut with shears. Supplied complete with adjusting screw, floating bar and lock nut. Hanger is finished grey.



FLUORESCENT AND SLIMLINE SHIELDED UNITS

Curtis "Store-Liter" Units

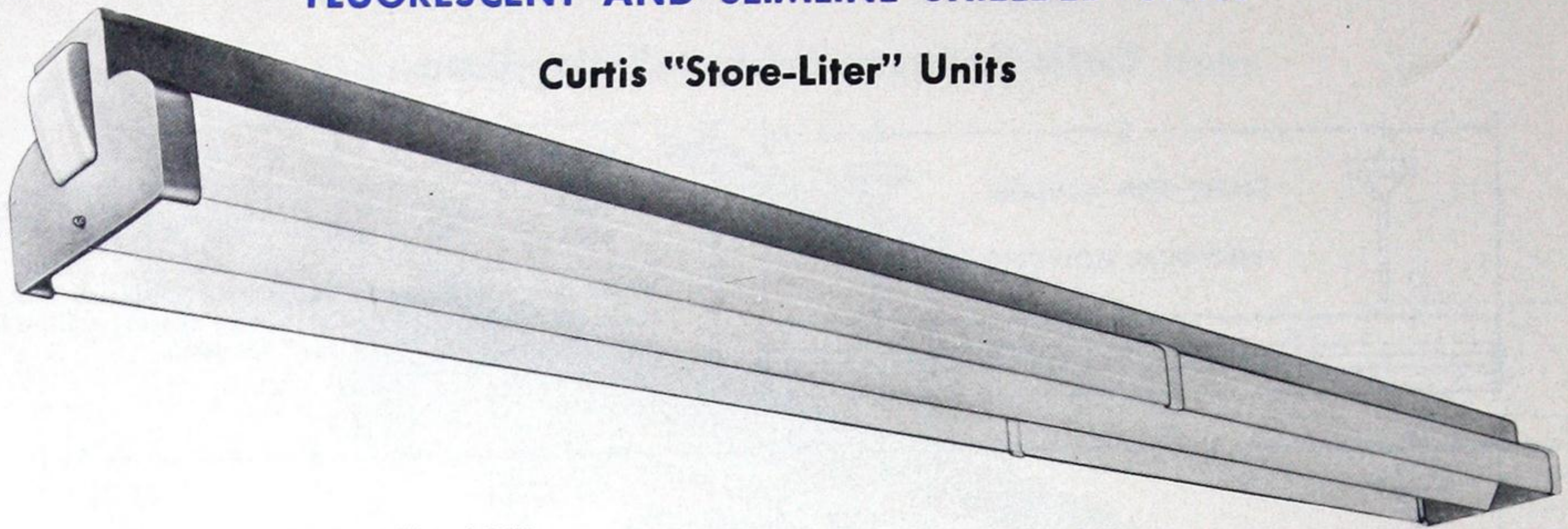

"Store-Liter" units are available for 48" and 96" T12 slimline lamps or 40W standard fluorescent lamps. They may be surface or suspension mounted continuously or as individual units.

CONSTRUCTION—Wire channel and longitudinal V-bar reflectors are constructed of heavy gauge steel, the channel is finished in light grey baked enamel and the V-bar reflector in baked white "Fluracite" of high reflection factor. The high transmission polystyrene plastic side panels have small lengthwise ribs which refract and diffuse the light, providing high levels of uniform illumination on vertical surfaces. Side panels are quickly and easily removed for cleaning, without the use of tools by simply sliding them back into the end plate until disengaged from the mid-point flange and then lifting out.

MOUNTING—"Store-Liter" units may be mounted individually or in continuous rows, either on the surface or suspended using Hangers as shown on the previous page. Sliding clamp No. 1009 may be used for surface or pendent mounting. This clamp permits by-passing of building construction obstacles, such as beams, sprinkler heads, etc., making hanger placement flexible.

WIRING—For 110-125V 60 cycle operation, "Store-Liter" units are supplied wired with High Power Factor 430 m.a. two-lamp ballasts for slimline units and High Power Factor best quality standard two-lamp ballasts for fluorescent units. Starters are not supplied.

INCANDESCENT SPOTS—"Store-Liter" units may be used in conjunction with No. 2241 In-Line Downlight and No. 2235 Corner Downlight to provide concentrated highlights on merchandise displays. These Downlights utilize 150W PAR-38 side prong projectors spot or flood lamps. No. 2241 In-Line Downlight has the same cross-section as the "Store-Liter" and is used in continuous rows. No. 2235 Corner Downlight allows the formation of decorative geometric patterns.

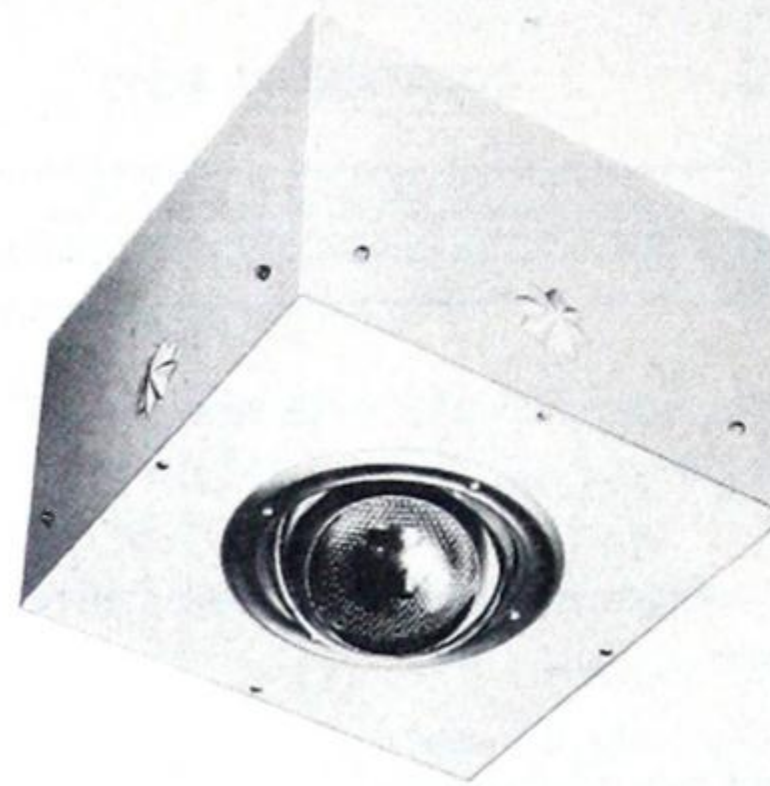

No. 2235

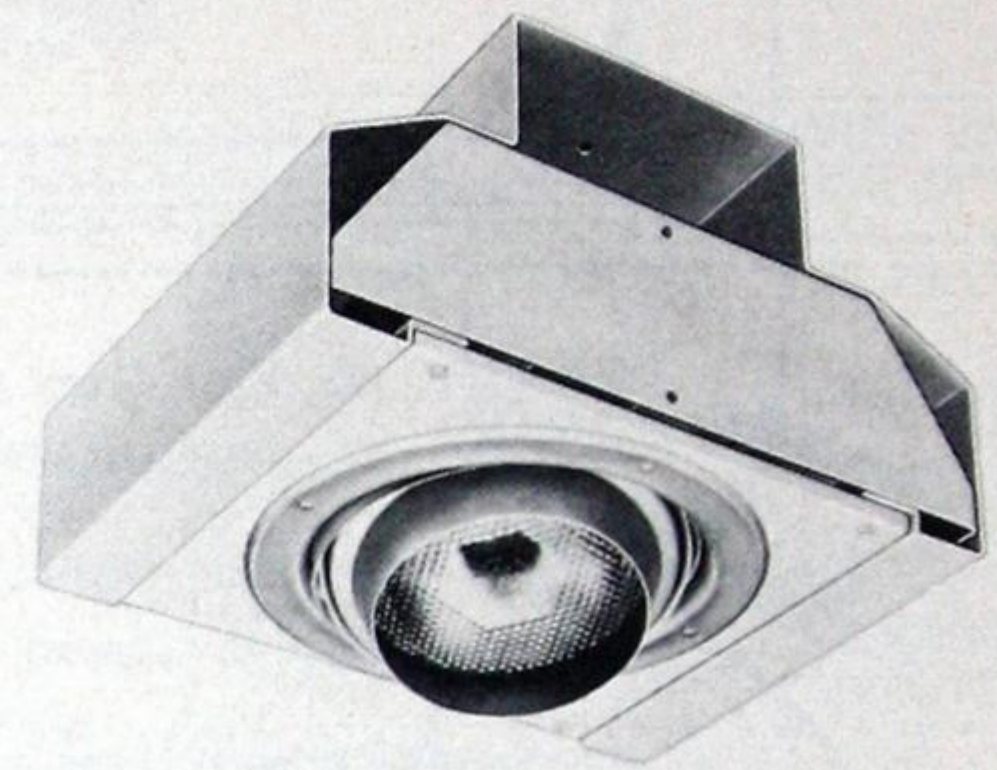

No. 2241

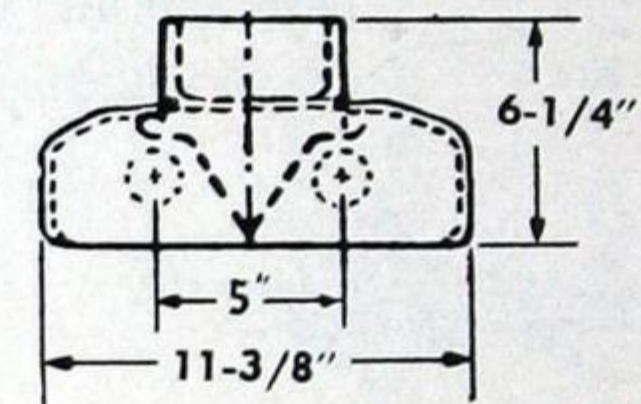

SHIELDING ANGLE	LENGTHWISE 0°	CROSSWISE 25°
SPACING	.75xMH	EFF 86.0%
M.F.	"STORE-LITER"	19.0%
G.75	7502-CLH	67.0%
M.65		
P.55		
CEILING	75%	50%
WALLS	50% 30% 10%	50% 30% 10%
ROOM INDEX	COEFFICIENT OF UTILISATION	
J	.33	.27 .24 .31 .27 .23
I	.40	.35 .32 .38 .34 .31
H	.44	.40 .37 .42 .39 .36
G	.49	.45 .41 .46 .42 .39
F	.53	.48 .44 .49 .45 .42
E	.57	.53 .49 .54 .50 .47
D	.62	.57 .53 .57 .54 .51
C	.64	.60 .55 .60 .56 .53
B	.68	.64 .60 .63 .59 .57
A	.70	.66 .63 .65 .61 .59

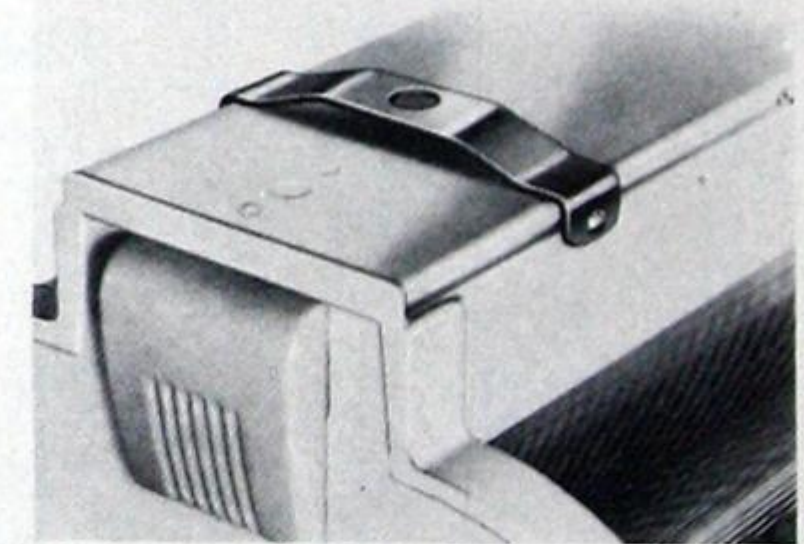

No. 1009

Catalogue No.**	Description	Lamps	Dimensions		
			Length	Width	Depth
7502-CLH*	Slimline "Store-Liter"	2 x 96" T8 or T12	96 3/8"	11 3/8"	6 1/4"
7504-CLH	Slimline "Store-Liter"	2 x 48" T12	48 3/8"	11 3/8"	6 1/4"
7507-CLH†	"Store-Liter"	2 x 40 W	48 3/8"	11 3/8"	6 1/4"
2241	In-Line Downlight	150W PAR-38 Side Prong	12"	11 1/8"	6 1/4"
2235	Corner Downlight		12 3/4"	12 3/4"	7 1/8"
1009	Sliding Clamp		—	—	—

*Units normally equipped with 430 ma ballasts or T12 lamps. 120, 200 or 300 ma ballasts for 96" T8 lamps supplied if specified.

†Available with Instant Start ballasts if specified.

**Specify hangers separately—See previous page.



FLUORESCENT SHIELDED UNITS

"Statesman" Units

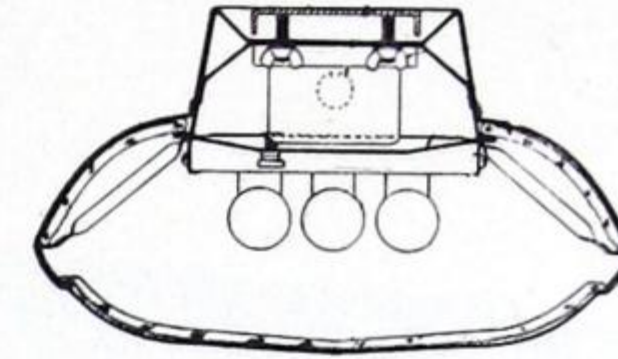
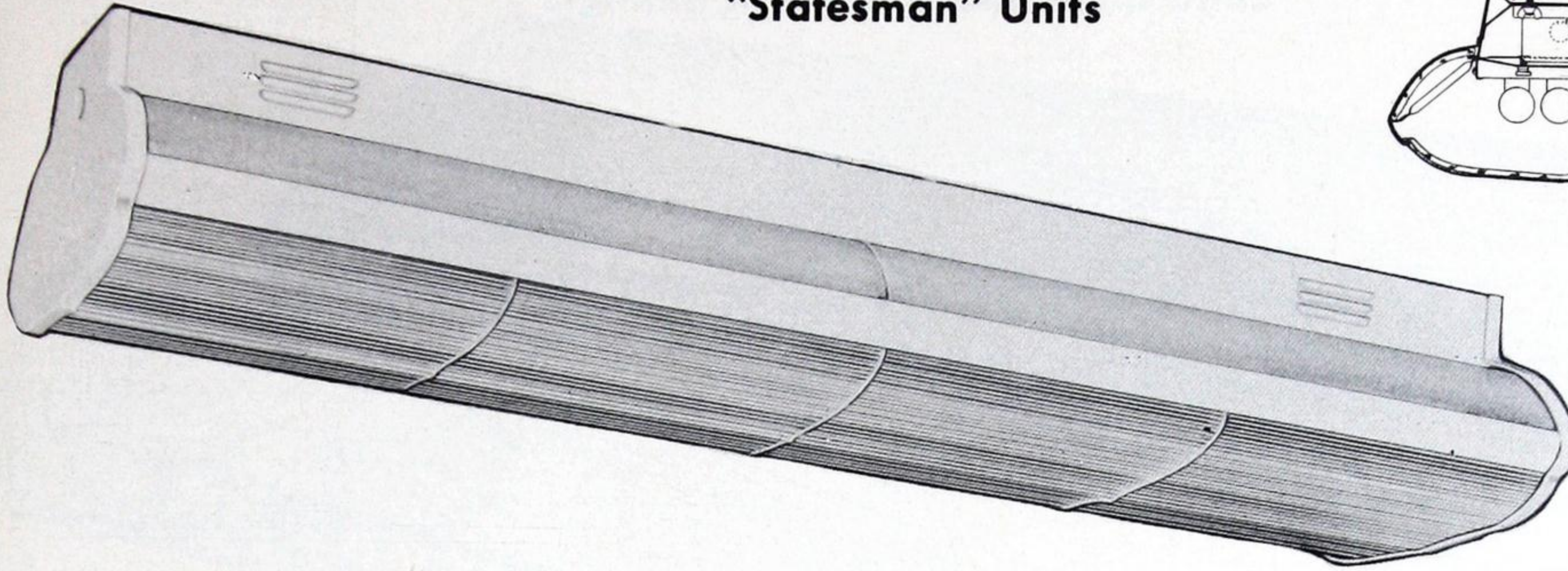

SPACING 1.25xMH EFF 73.5%						
M.F.	"STATESMAN"					16.0%
G.75	9110-A					57.5%
M.70						
P.65						
CEILING	75%		50%			
WALLS	50%	30%	10%	50%	30%	10%
ROOM INDEX	COEFFICIENT OF UTILISATION					
J	.32	.27	.25	.30	.27	.25
I	.38	.35	.33	.36	.34	.32
H	.41	.38	.36	.40	.37	.35
G	.45	.42	.40	.43	.41	.39
F	.48	.46	.44	.45	.43	.41
E	.51	.49	.47	.49	.47	.45
D	.55	.51	.49	.52	.49	.47
C	.57	.54	.52	.54	.52	.50
B	.59	.57	.55	.55	.54	.52
A	.61	.58	.56	.57	.55	.53

SPACING 1.25xMH EFF 63.8%						
M.F.	"STATESMAN"					11.9%
G.75	9111-A					51.9%
M.70						
P.65						
CEILING	75%		50%			
WALLS	50%	30%	10%	50%	30%	10%
ROOM INDEX	COEFFICIENT OF UTILISATION					
J	.29	.26	.24	.28	.26	.24
I	.35	.32	.30	.33	.31	.29
H	.38	.35	.33	.37	.35	.33
G	.41	.38	.36	.39	.37	.35
F	.43	.41	.39	.41	.39	.37
E	.46	.45	.43	.43	.42	.40
D	.49	.47	.45	.47	.44	.42
C	.50	.48	.46	.48	.47	.45
B	.52	.50	.48	.50	.48	.46
A	.54	.53	.51	.51	.50	.48

SPACING 1.25xMH EFF 61.6%						
M.F.	"STATESMAN"					14.0%
G.70	9112-A					47.6%
M.65						
P.60						
CEILING	75%		50%			
WALLS	50%	30%	10%	50%	30%	10%
ROOM INDEX	COEFFICIENT OF UTILISATION					
J	.27	.24	.23	.26	.23	.22
I	.32	.30	.28	.31	.29	.27
H	.35	.33	.32	.34	.32	.30
G	.38	.36	.33	.36	.34	.32
F	.40	.38	.35	.38	.36	.34
E	.43	.41	.37	.41	.39	.37
D	.46	.44	.41	.44	.42	.40
C	.48	.46	.43	.45	.43	.41
B	.50	.47	.44	.47	.44	.41
A	.51	.49	.46	.48	.46	.44

"Statesman" units are available for two, three, or four 40W fluorescent lamps for surface or suspension mounting as individual units or in continuous rows.

LIGHTING PERFORMANCE—The "Statesman" unit is equipped with four individual No. 9100 Controlens (R) butted together so as to function as one continuous lens. This lens directs and transmits 66% of the light from the unit into the useful 0-60 degree zone. The result is a highly efficient production of illumination and a notable absence of glare.

The upper glass member has a double function; i.e., that of a reflector to augment the light directed from the lamps to the lens, thus, adding to the downward component of the unit; and that of a refractor which, permitting certain light rays to pass through, spreads them widely across the ceiling furnishing a luminous background to the unit. All glass parts are carefully fitted to prevent the collection of dust on the inside of the unit.

FINISH—All metal parts finished in baked white enamel.

MOUNTING—Units may be surface mounted or suspended on No. 9199 double stem 24" rod hanger.

WIRING—All units are wired and furnished complete with best quality fully compensated ballasts and automatic reset starters.

Catalogue No.	Description	Lamps	Cycles	Dimensions		
				Length	Width	Depth
9110-A	Refracting Glass Top Panels	2 x 40W	60	48 1/8"	14 1/4"	8 1/2"
9110-S*	Refracting Glass Top Panels	2 x 40W	60	48 1/8"	14 1/4"	8 1/2"
9111-A	Refracting Glass Top Panels	3 x 40W	60	48 1/8"	14 1/4"	8 1/2"
9112-A	Refracting Glass Top Panels	4 x 40W	60	48 1/8"	14 1/4"	8 1/2"
9112-S*	Refracting Glass Top Panels	4 x 40W	60	48 1/8"	14 1/4"	8 1/2"
9110-B	Refracting Glass Top Panels	2 x 40W	25	48 1/8"	14 1/4"	8 1/2"
9112-B	Refracting Glass Top Panels	4 x 40W	25	48 1/8"	14 1/4"	8 1/2"
9110-BM	Metal Top Panels	2 x 40W	25	48 1/8"	14 1/4"	8 1/2"
9112-BM	Metal Top Panels	4 x 40W	25	48 1/8"	14 1/4"	8 1/2"
9199	Two Stem Hanger	—	—	24"	—	—

*Instant Start.

(R) The Holophane Co. Ltd.



FLUORESCENT SHIELDED UNITS

Holoflux(R) Units

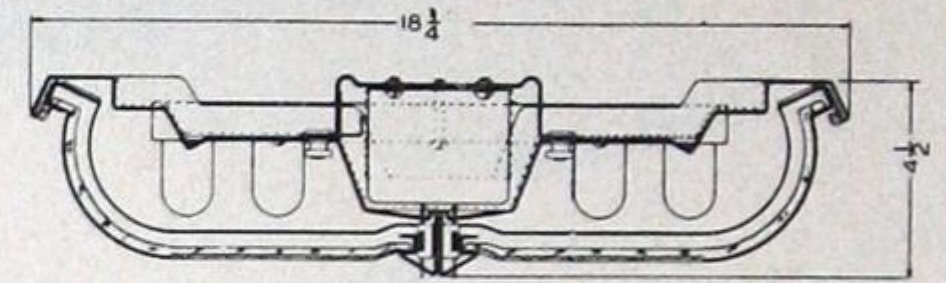
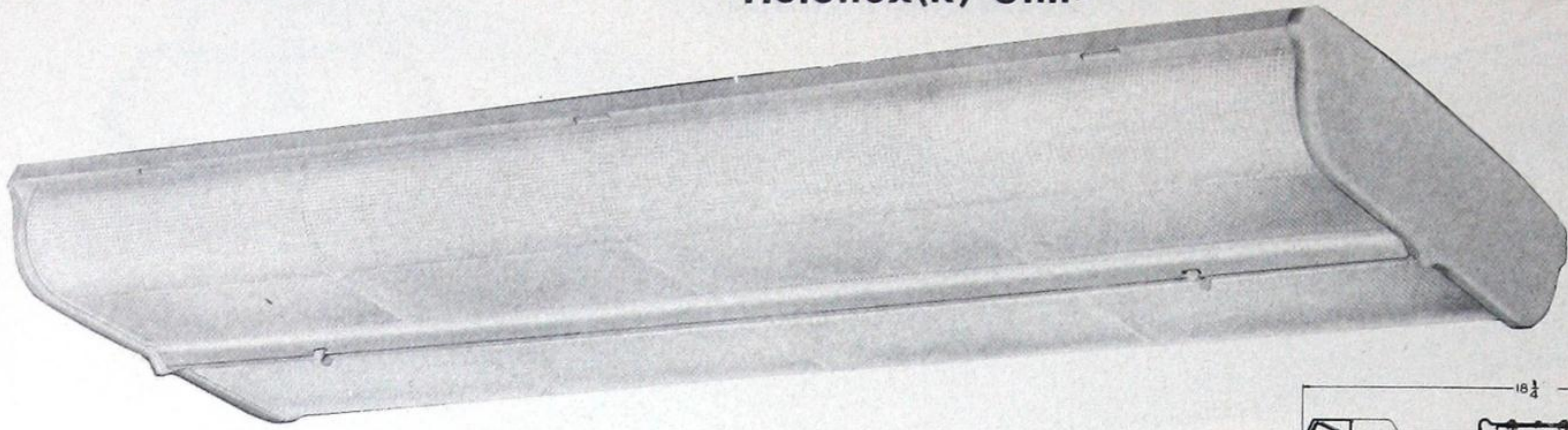

SPACING 1.25xM.H. EFF 61.7%

M.F.	HOL		5.2%			
G.85	104		↑			
M.75			↓			
P.65			56.5%			
CEILING	75%		50%			
WALLS	50%	30%	10%	50%	30%	10%
ROOM INDEX	COEFFICIENT OF UTILISATION					
	.30	.28	.26	.30	.27	.26
	.36	.34	.33	.36	.34	.32
	.40	.38	.37	.39	.37	.36
	.43	.41	.40	.41	.40	.38
	.45	.43	.41	.43	.42	.40
	.48	.46	.44	.47	.45	.43
	.51	.48	.47	.49	.47	.46
	.52	.50	.48	.51	.49	.47
	.54	.52	.50	.52	.50	.49
	.55	.53	.51	.53	.51	.50

The unit consists of a ceiling channel which serves as a mounting base for lamps and high power factor type ballasts, the wiring cover enclosing the ballasts, two lampholder pans, two end plates and two hinged doors. Unit sections can be mounted end to end to form continuous runs.

Access to the lamp chamber is provided by doors, each holding four glass lenses. Each door is attached to the ceiling pan by means of three slot type hinges, evenly spaced along the length of the unit, and are held in a closed position by two spring type latches. The lenses are held in the doors by means of a continuous channel along one flange and removable metal angle strips along the opposite flange. Each door may be removed from the slot type hinges when in open position.

The glass assembly consists of four crystal glass lenses per door.

The lampholders are secured to the lampholder pans which are, in turn, secured to the ceiling pan.

Steel parts are bonderized and finished with prime and white enamel coatings.

Unit Catalogue No.	End Plate Catalogue No.*	Lamps	Dimensions			
			Length		Height	Width
			With End Plate	Less End Plate		
FLUORESCENT						
HOL-104	099	4x40W	50"	48"	4 1/2"	18 1/4"
SLIMLINE						
HOL-114	099	4 x 48" T12	50"	48"	4 1/2"	18 1/4"
HOL-124	099	4 x 96" T12	98"	96"	4 1/2"	18 1/4"

*Specify separately—Two per individual unit or continuous row.
Note—Replacement lenses—Catalogue No. 100, 4 per 4' length of fixture.

SUGGESTED INSTALLATION PROCEDURE

For continuous runs fasten ceiling channel by means of four screw anchors, expansion shields, or toggle bolts through four 1/2" holes, 2 3/4" x 34" on centers, as shown at "A". Wires may be brought into fixtures through knockouts "B" or by exposed metal moulding through end plate knockout at "C".

Mount remaining channels with ends butting. Bolt together through holes "D", screws and nuts provided.

Fasten cover pan to ceiling channel with lock nuts. Pan should seat against bottom flange of ceiling channel and at the same time the edges of the pan should clear or just touch the ceiling. If necessary, drop ceiling channel slightly so that pan can be mounted without distortion.

Install end plates. Fasten to cover pan through holes "E", screws provided.

Place No. 100 lenses in doors and hook doors to cover pan. Swing up and latch.

FOR SINGLE UNITS—Proceed as outlined above.

FOR UNITS USING 8 FT. LAMPS—Unit is shipped in two 4 ft. sections. Mount and assemble same as for continuous rows, except lampholders are 8 ft. apart. Splice wires between 4 ft. sections. Wires to be spliced are identified by identical numbers. Connectors are provided.

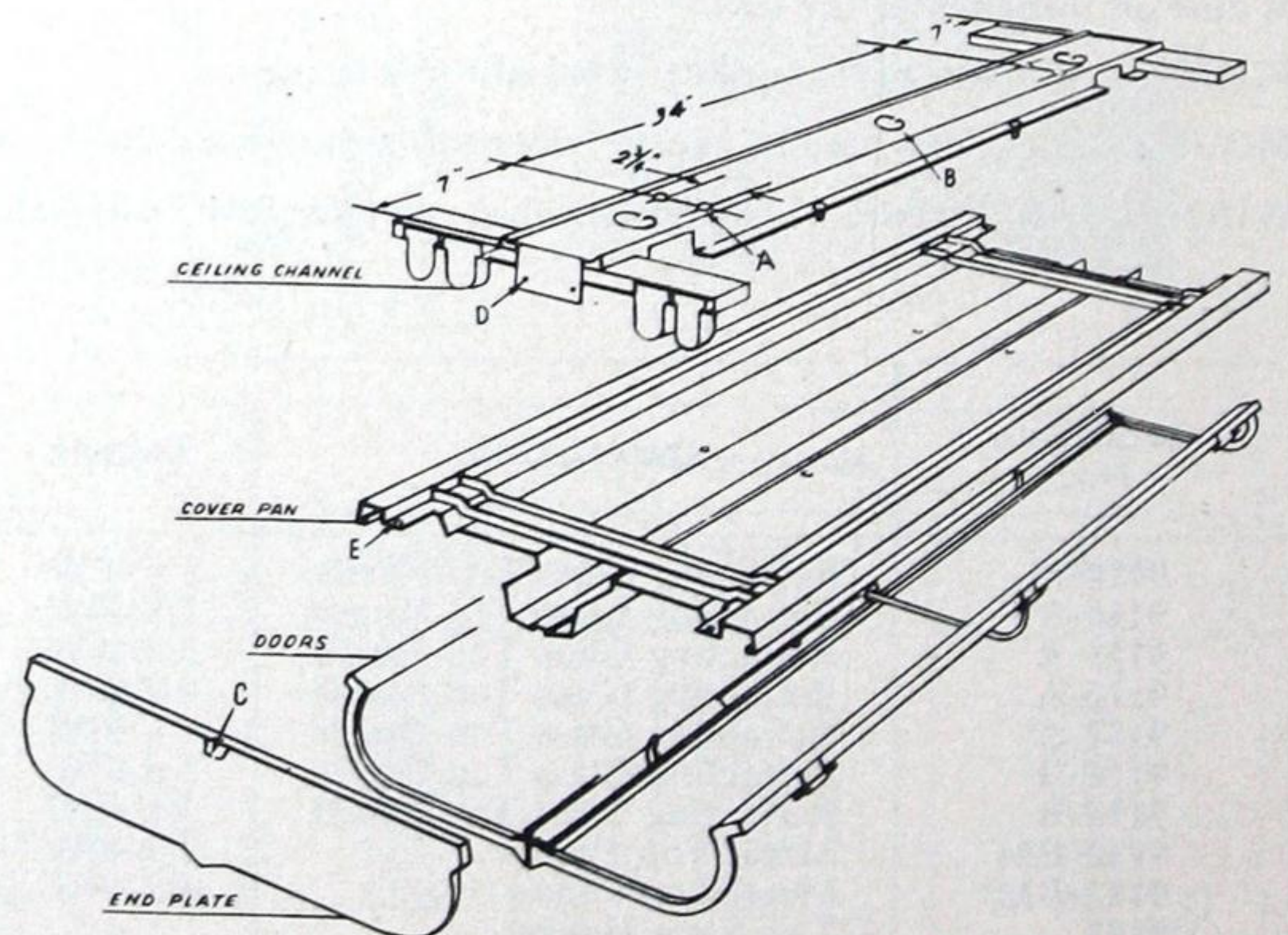

(R) The Holophane Co. Ltd.



FLUORESCENT SHIELDED UNITS

Lighting Materials Aluminum Units

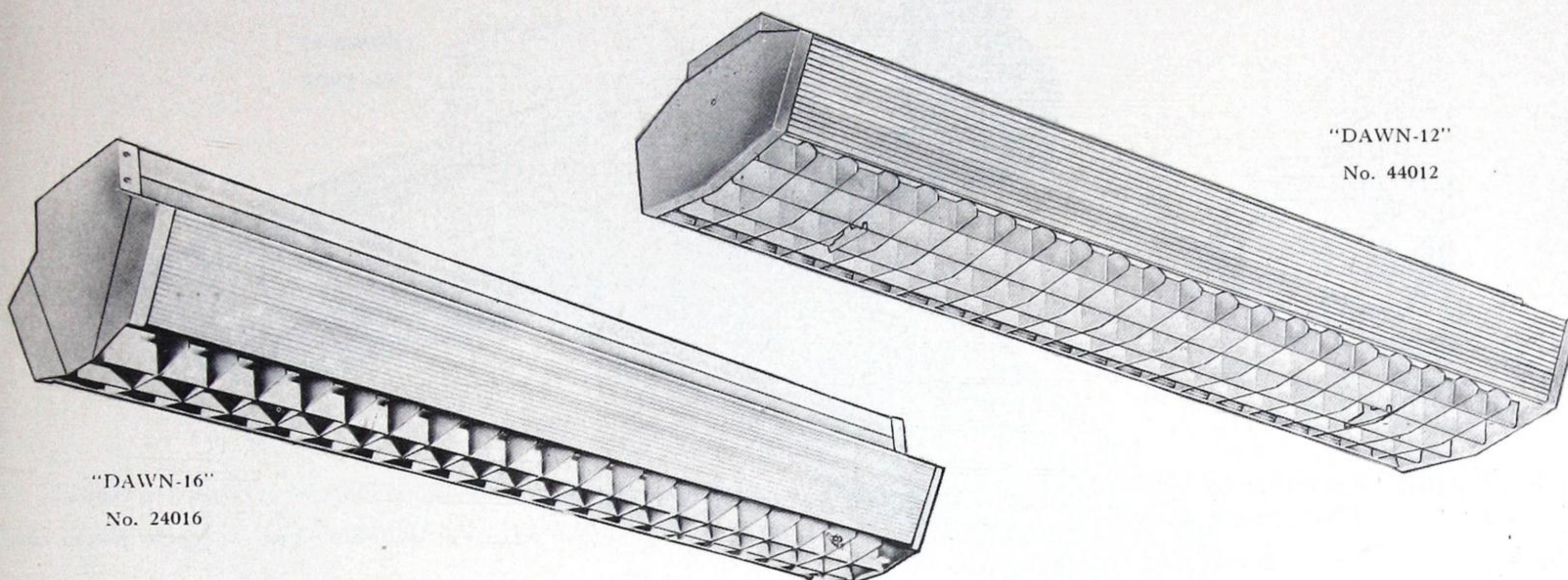

"DAWN-16"
No. 24016

"DAWN-12"
No. 44012

SHIELDING ANGLE		LENGTHWISE 30°		CROSSWISE 35°		
SPACING 1.0xMH		EFF 74.8%				
M.F.	"DAWN-16"		27.7%			
G.70	24016		47.1%			
M.65						
P.60						
CEILING	75%		50%			
WALLS	50%	30%	10%	50%	30%	10%
ROOM INDEX	COEFFICIENT OF UTILISATION					
J	.24	.20	.17	.22	.18	.16
I	.29	.25	.23	.27	.23	.21
H	.32	.28	.26	.30	.26	.24
G	.36	.32	.29	.33	.29	.27
F	.40	.36	.32	.35	.32	.30
E	.44	.40	.36	.39	.36	.33
D	.47	.43	.39	.42	.39	.36
C	.50	.46	.42	.44	.41	.38
B	.53	.49	.46	.47	.43	.41
A	.55	.51	.48	.49	.45	.43

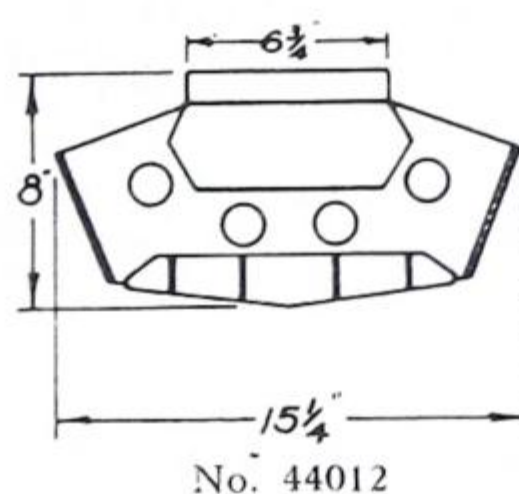
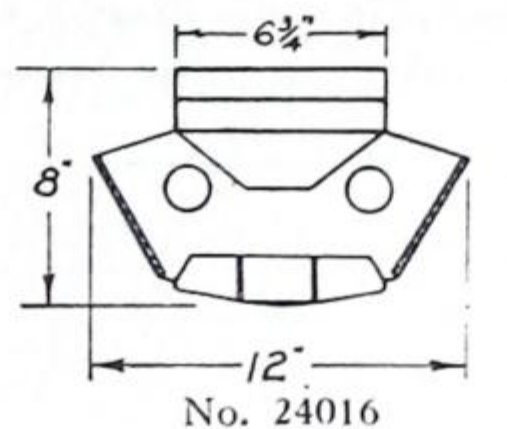

SHIELDING ANGLE		LENGTHWISE 28°		CROSSWISE 35°		
SPACING 1.0xMH		EFF 69.5%				
M.F.	"DAWN-12"		25.8%			
G.70	44012		43.7%			
M.65						
P.60						
CEILING	75%		50%			
WALLS	50%	30%	10%	50%	30%	10%
ROOM INDEX	COEFFICIENT OF UTILISATION					
J	.24	.21	.19	.23	.20	.19
I	.30	.27	.25	.28	.25	.24
H	.33	.30	.28	.31	.28	.27
G	.36	.33	.31	.34	.31	.29
F	.39	.36	.33	.36	.33	.31
E	.42	.40	.37	.39	.37	.34
D	.46	.42	.40	.42	.39	.37
C	.48	.45	.41	.43	.41	.39
B	.50	.49	.47	.47	.45	.43
A	.52	.50	.47	.47	.45	.43

"Dawn-16" and "Dawn-12"

Complete two and four lamp shielded units for surface or suspension mounting as individual units or in continuous rows.

CONSTRUCTION—All metal parts are of aluminum for light weight and durability. A separate ceiling pan with mounting bolts to attach the fixture proper is available when specified and acts as a wiring trough for end to end mounting. The ballast pan of the fixture has socket straps apart from the cover so the cover may be removed for installation without disturbing the fixture wiring. The louver is suspended in position and hinges from weld pins on the end plates. Side panels are Albalite glass.

FINISH—All metal parts of fixture have the patented Alumilite finish. Alumilite is an electro-chemical process on aluminum which produces a hard, non-tarnishing, easy to clean surface, satin silver in appearance.

MOUNTING—Use hangers listed on next page.

WIRING—40 watt units are supplied wired with best quality fully compensated ballasts and automatic reset starters. Instant Start or Dual-Frequency Ballasts available if specified. 20 watt units supplied wired with best quality high power factor ballasts and standard starters.

Catalogue No.*	Description	Lamp	Cycles	Volts	Dimensions		
					Length	Width	Depth
22016	"Dawn-16"	2 x 20W	60	110-125	24"	12"	8"
24016†	"Dawn-16"	2 x 40W	60	110-125	48"	12"	8"
44012†	"Dawn-12"	4 x 40W	60	110-125	48 1/8"	15 1/4"	8"

*Ceiling mounting pan available if specified.

†Available for Instant Start or 25 cycle operation (dual frequency ballast) if specified.



FLUORESCENT SHIELDED UNITS

Lighting Materials Aluminum Units

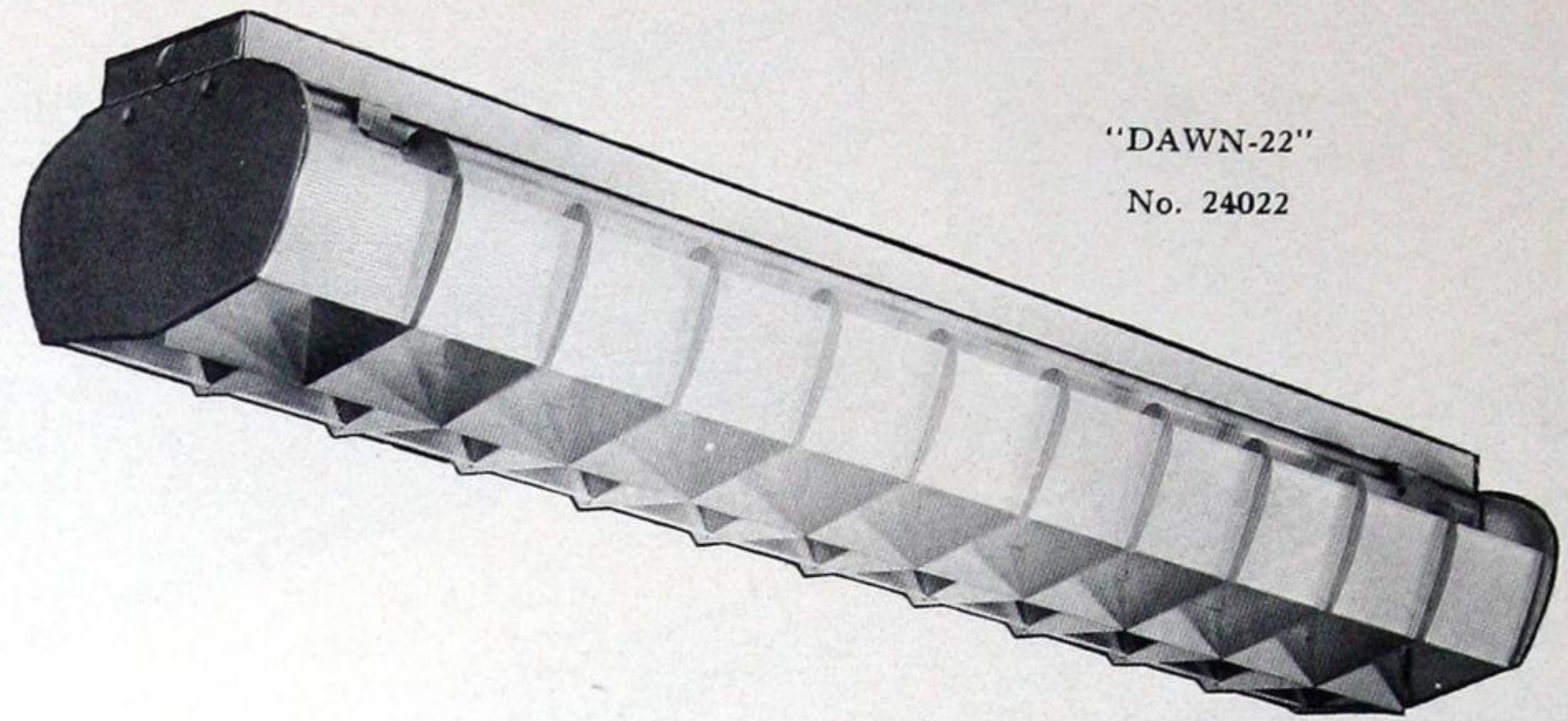

"DAWN-22"
No. 24022

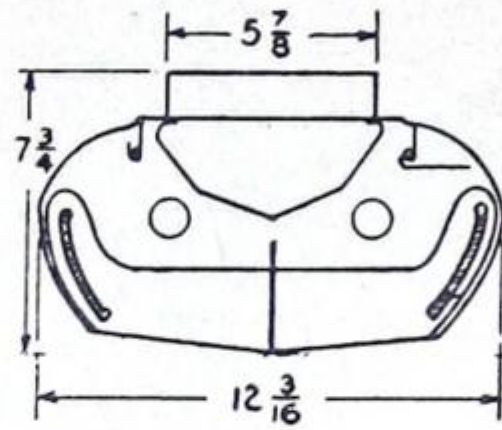

SHIELDING LENGTHWISE 25° ANGLE CROSSWISE 45°		SPACING 1.0xMH		EFF 71.8%
M.F.	"DAWN-22"			28.2%
G.70				43.6%
M.65	24022			
P.60				
CEILING	75%			50%
WALLS	50%	30%	10%	50%
	30%	10%	50%	30%
	10%	50%	30%	10%
ROOM INDEX	COEFFICIENT OF UTILISATION			
J	.24	.21	.19	.22
I	.30	.26	.24	.27
H	.33	.30	.27	.30
G	.36	.33	.31	.33
F	.39	.35	.33	.35
E	.42	.39	.37	.39
D	.46	.42	.39	.41
C	.47	.44	.41	.43
B	.50	.47	.44	.45
A	.52	.49	.46	.47

Complete units for surface or suspension mounting as individual units or in continuous rows.
CONSTRUCTION—All metal parts are aluminum with Alumilite finish and side panels are polystyrene plastic.

Louver is secured by snap clips and may be hinged down from one side for servicing. A separate ceiling pan with mounting bolts to attach the fixture proper is available when specified and acts as a wiring trough for end to end mounting.

MOUNTING—For surface mounting, or suspension mounting, using hangers listed below.

WIRING—40 watt units supplied fully wired with best quality fully compensated ballasts and automatic reset starters. Instant Start or Dual Frequency Ballasts available if specified. 20W units supplied wired with best quality high power factor ballasts and standard starters.

Catalogue No.*	Description	Lamps	Cycles	Volts	Dimensions		
					Length	Width	Depth
22022	"Dawn-22"	2x20W	60	110-125	24 ⁵ / ₁₆ "	12 ³ / ₁₆ "	7 ³ / ₄ "
24022**	"Dawn-22"	2x40W	60	110-125	48 ⁵ / ₁₆ "	12 ³ / ₁₆ "	7 ³ / ₄ "

*Ceiling mounting pan available if specified.

**Available for Instant start or 25 cycle operation (dual frequency ballast) if specified.



No. 7789--8"

No. 7719--24"

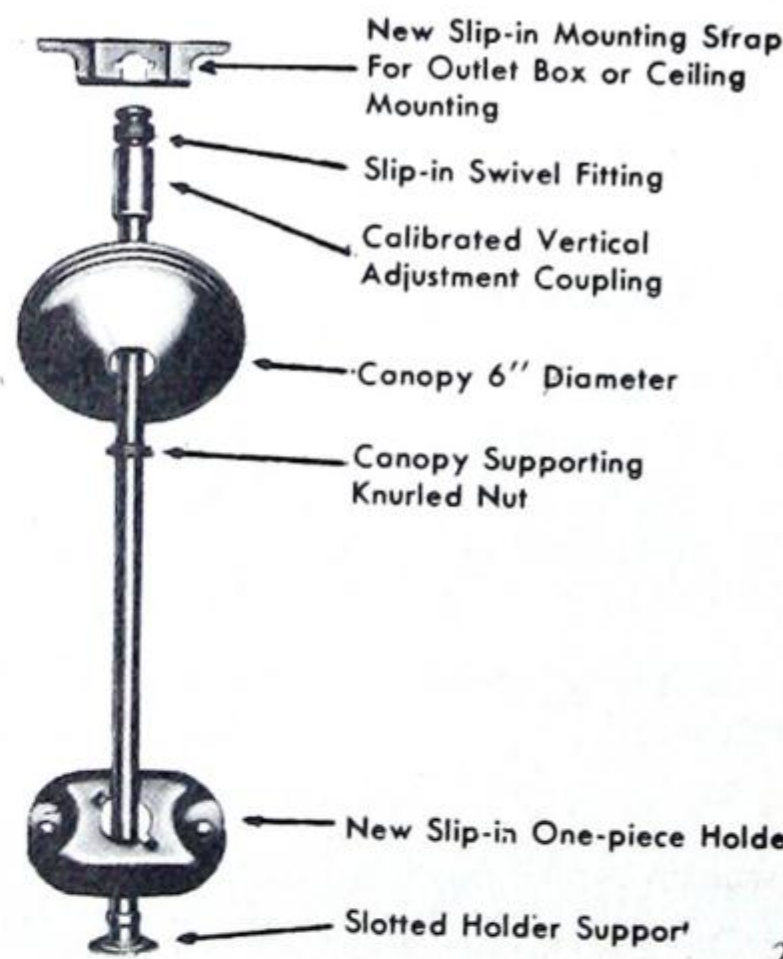

No. 7789, 7719 EXPANDED VIEW

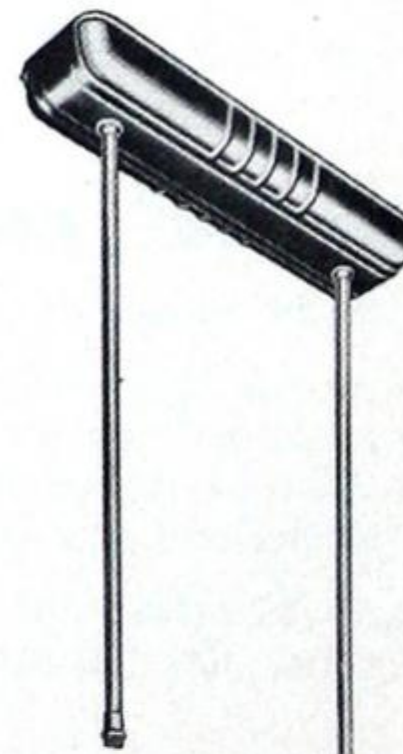

DOUBLE STEM
24" HANGER--STANDARD
No. 9925

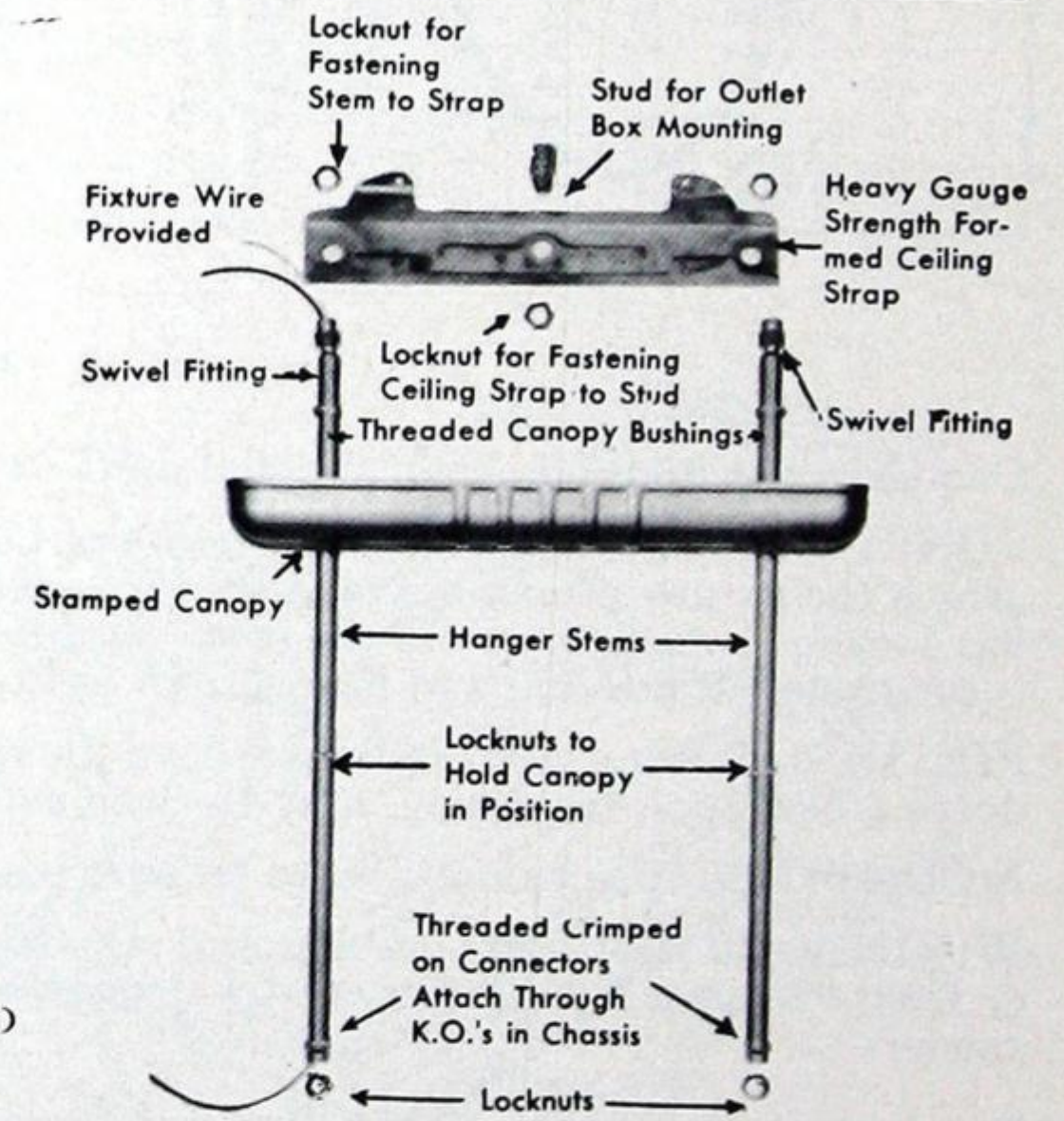

No. 9925 EXPANDED VIEW

Hangers

Catalogue No.*	Description	Length
7789	Single stem hanger	8"
7719	Single stem hanger	24"
9925	Double-stem hanger	24"

*Standard finish is Metallic Grey. For White Enamel finish add suffix "W" to Catalogue No.



FLUORESCENT AND SLIMLINE SHIELDED UNITS

Wilson "Corri-Lite" Units

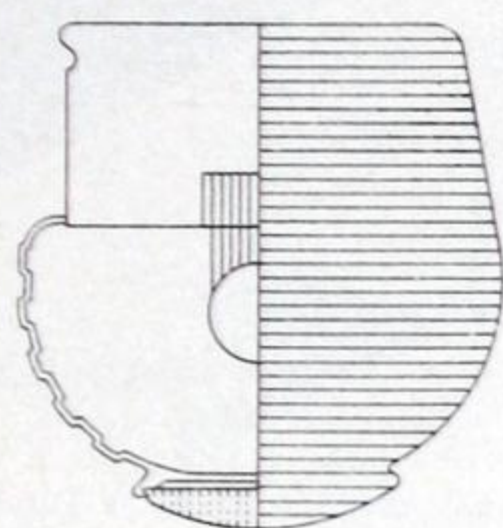
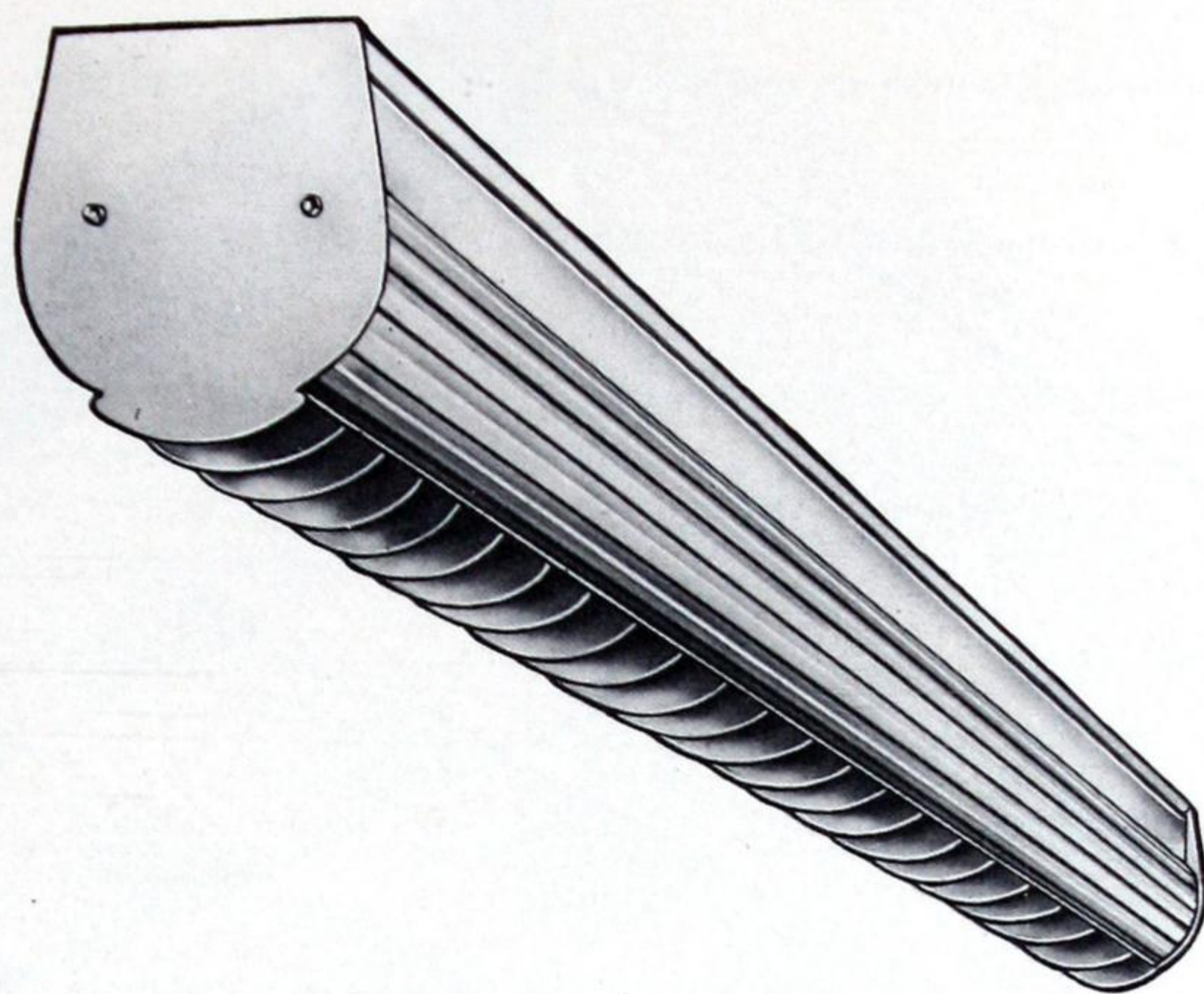

The "Corri-Lite" unit provides an answer to the difficult job of lighting corridors. The clean-cut functional design of this unit will blend well into the general architectural appearance of any corridor and provide evenly diffused lighting and pleasing appearance.

Specify and install this unit in corridors, main halls, lobbies, elevator foyers, stairways, and other areas where appearance counts and lighting for safety is important. May also be used in lounges, waiting rooms, and other public areas where uni-line lighting is pleasing. The unit is particularly suitable for lighting applications where exposed beams preclude the use of standard units.

The attractive and rigidly constructed louver provides adequate shielding from below, and a large portion of the light is directed outwards to corridor walls or shelves when the unit is used for bookstack lighting. The high-grade plastic diffusing shield is mounted on a sturdy channel which carries slimline or standard fluorescent lamps in a single row. The plastic shield provides light control and fits tightly to the channel making a dust-tight unit. It is easily removable for cleaning or relamping. A proportion of the light output is directed to the ceiling eliminating any undesirable contrast between the fixture and its background. The wide channel base is strongly constructed of 20 Gauge steel, with infra-red baked white enamel finish.

The end plates are simple, but functional and will not detract from any architectural theme. Good appearance is maintained where it is necessary to mount the units individually.

The unit is designed for either ceiling mounting or suspension mounting as individual units or in continuous rows. Adequate knock-outs are provided for fixing holes, suspension hangers and wiring and the shaped channel construction of the basic unit allows the use of ice-tong hangers.

Shaped channel for longitudinal rigidity and provision for ice tong hangers.

Basic unit housing ballast and lamp sockets.

Filled end plates provide completely enclosed single unit and ensure correct alignment and rigidity for continuous row mounting.

Plastic diffusing shield, removable for relamping and servicing.

Removable louver to ensure adequate longitudinal shielding.

TYPICAL CROSS-SECTION-SLIMLINE UNIT

Catalogue No.	Lamp	Cycles	Fixture Length	Ballast
---------------	------	--------	----------------	---------

For Use With Slimline Lamps

LCS134	1x48" T12	60	4'	430 ma
LCS238	2x48" T12	60	8'	430 ma
LCS178*	1x96" T8 or T12	60	8'	T8-200 ma or T12-430 ma
LCS2716*	2x96" T8 or T12	60	16'***	

*Specify ballast rating—Units for use with T8 lamps supplied with 200 ma ballast. Units for use with T12 lamps supplied with 430 ma ballast.

**LCS2716 unit supplied as 2-8' sections with joiner strap and a single 2-lamp ballast located in one section.

For Use With Standard Fluorescent Lamps

LCS144	1x40W	60	4'	Single lamp H.P.F.
LCS248*	2x40W	60	8'	Two-lamp H.P.F.

*Available for instant start or 25 cycle operation if specified.



LUMINOUS CEILINGS

Wilson "Luve-Tile"

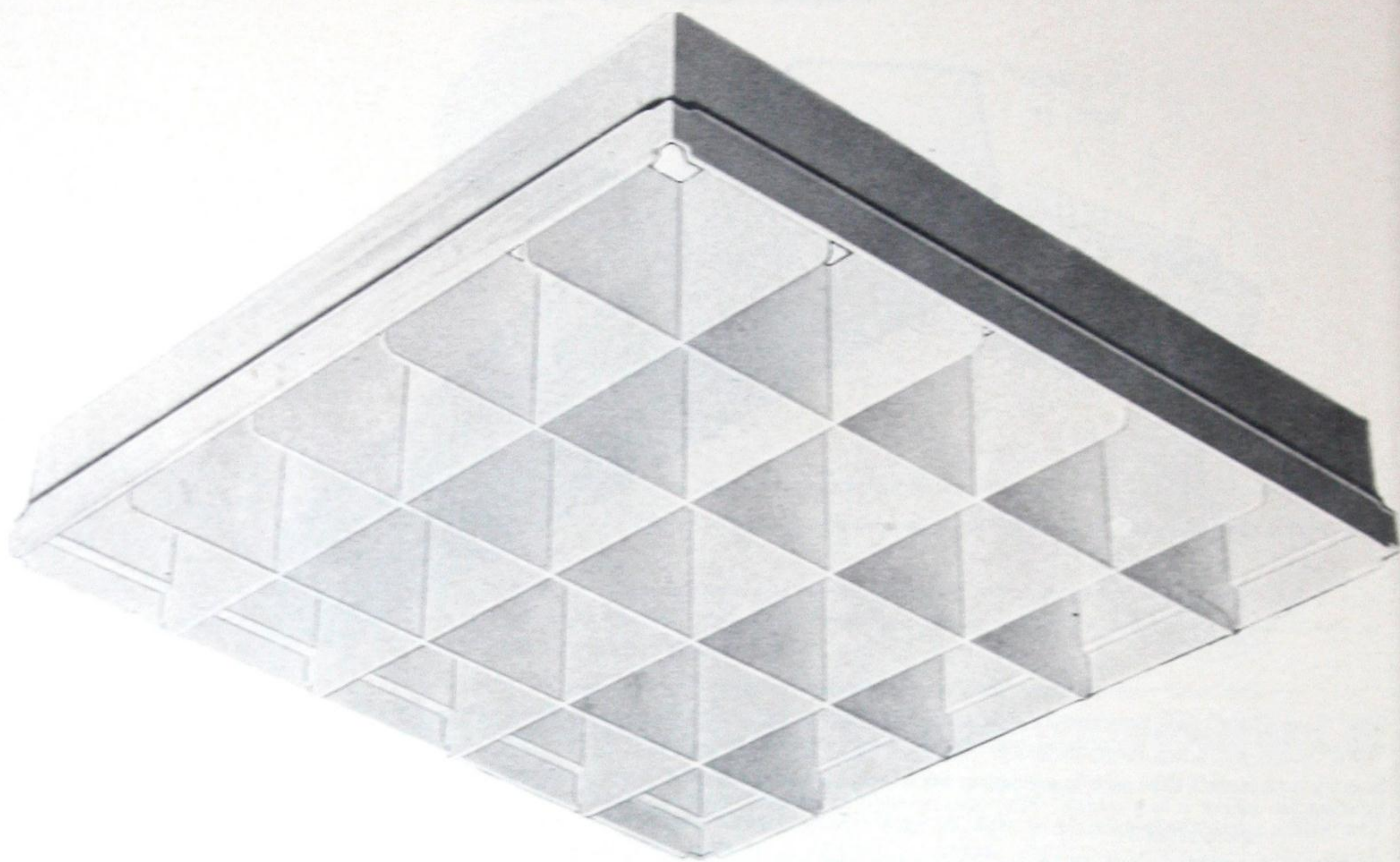

The Luve-Tile is a 12" x 12" square louvered panel of moulded styrene plastic. A complete Luve-Tile ceiling consists of a number of separate Luve-Tiles assembled into sections 2' x 2', 2' x 3' or 3' x 3' by use of simple joining clips.

These individual sections are then suspended by suitable hangers, with the result that a louvered ceiling is comprised of a number of sections each of which may be completely removed from the hangers for cleaning purposes, or simply hinged down from either side to permit access to the lighting equipment for maintenance or relamping purposes.

The unique hanger arrangement makes the servicing of Luve-Tile ceilings simplicity itself, as panels may be removed or hinged without the use of tools. It is only necessary to raise the section slightly and disengage the spring loaded hanger clip.

Features

Provides Easy Maintenance—Luve-Tile hinges for relamping and servicing of fixtures above. Rigid to handle, light weight, easy to remove and wash.

Cost Per Square Foot—All things considered; high efficiency, handling, installation, life-maintenance, replacement parts, material depreciation, Luve-Tile will prove to be more economical than any other illuminated ceiling.

Stays Clean Longer—Dirt collection is less rapid or noticeable than with other types of luminous ceilings.

Patterned Ceilings in Colour—Unlimited colour combinations possible. Efficient white light provided on the working plane.

Simple Economical Fabrication—No costly custom-made work necessary. Basic louvered unit may be assembled to suit any room conditions. No unsightly horizontal bars or rosettes are used for support.

Conceals Sprinklers and Air Ducts—Also, if desired, Germicidal lamps, sun lamps, radiant heating or spotlights. Low cost acoustic material may be sprayed on the cavity above the tile for soundproofing. Wiring and other work may be simply surface mounted.

Proper Brightness Control—Offers lower ceiling brightnesses especially for higher intensities of light, 50 to 100 footcandles and more.

Ease of Ordering—Basic unit shipped in carton of 12 with sufficient joiner clips included. Order hangers extra as required.



LUMINOUS CEILINGS

Wilson "Luve-Tile"

GENERAL INFORMATION

White Luve-Tile absorbs only 20% of the light passing through it. To calculate the lighting system, therefore, proceed in the usual way (lumen method) as if there were no Luve-Tile, then subtract 20%.

Coloured tile will not fade over long periods of time and will not change the colour of the light passing through it but provide white light efficiently on the working plane.

Luve-Tile will not shrink other than natural contraction or expansion due to variation in the temperature. Heat distortion point is 175°-180°. Experience indicates that it is not necessary to allow for expansion because of the space already allowed between the doors for clearance. Definitely not a fire hazard. Only after a period of time in contact with flame will the tile support combustion. Sprinkler systems or automatic CO₂ extinguishers can be concealed above the tile.

Luve-Tile can be cut in any size by a hacksaw, will not interfere with heat convection or air conditioning, is not affected by moisture and is acoustically neutral.

Light Sources

The light source above the tile may be incandescent or standard fluorescent or slimline, the latter two being more generally preferred. Lamp spacing should be not more than twice the distance between lamp and top of tile. Single or double bare fluorescent lamps may be used without reflector for clean cavities of depths under 42". For cavity depths greater than 42" or places where good maintenance is questionable, use single or double lamp reflector type fixtures.

Spotlights may be used above Luve-Tile to highlight objects below provided a distance of 12" is maintained between top of tile and spotlight. Striking colour effects in the tile may be obtained by using coloured lenses on the spotlights. Glare-free colour effects may be obtained by using coloured fluorescent lamps above white Luve-Tile.

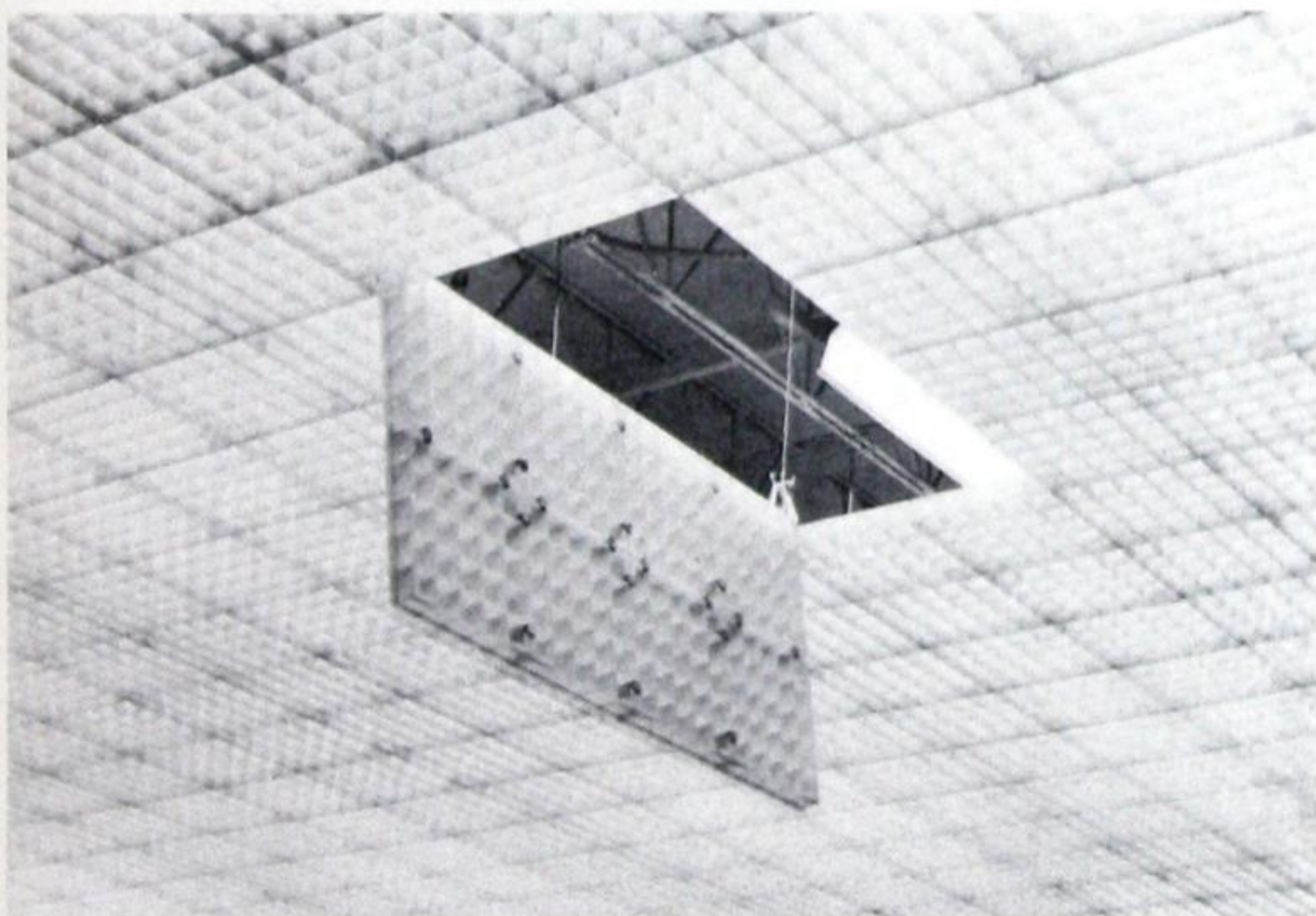

"LUVE-TILE" HINGES 90°. NOTE PATENTED HANGER HOOK



CLIPPING "LUVE-TILE" MODULAR SQUARES TOGETHER FOR DOORS. LAY ON LEVEL SURFACE AND PRESS CLIPS ON WITH THUMB

Methods of Mounting

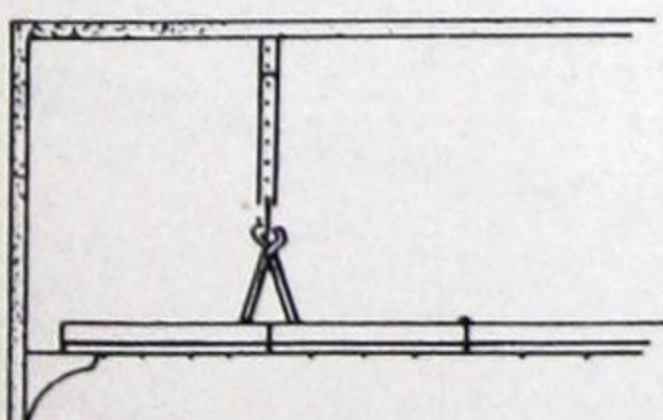

1. START FIRST HINGING HANGER ONE TILE FROM EDGE. 4-HOOK HANGER REQUIRED.

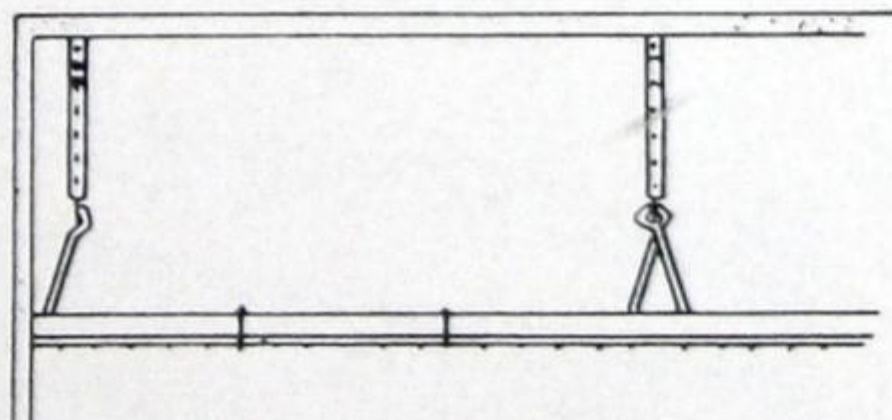

2. BUTT TO WALL—FIRST HANGER WILL BE 2-HOOK TYPE AT WALL.

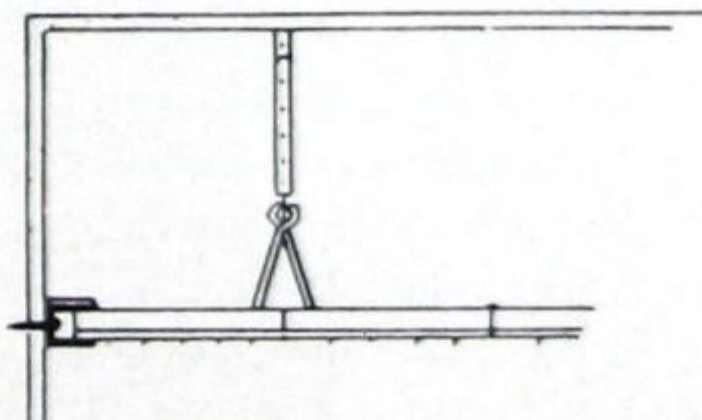

3. METAL U-SHAPED CHANNEL—PROVIDED BY OTHERS—PAINT TO MATCH WALL.

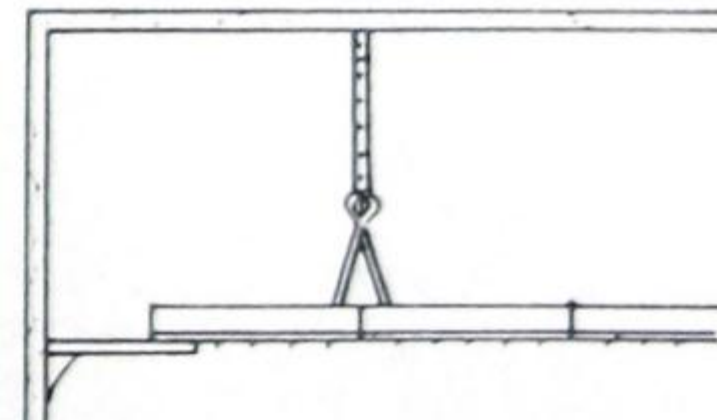

4. IF ROOM WIDTH ISN'T TO AN EVEN FOOT—PROVIDE WIDE WOOD MOULD OR TRIM.



LUMINOUS CEILING

Wilson "Luve-Tile"

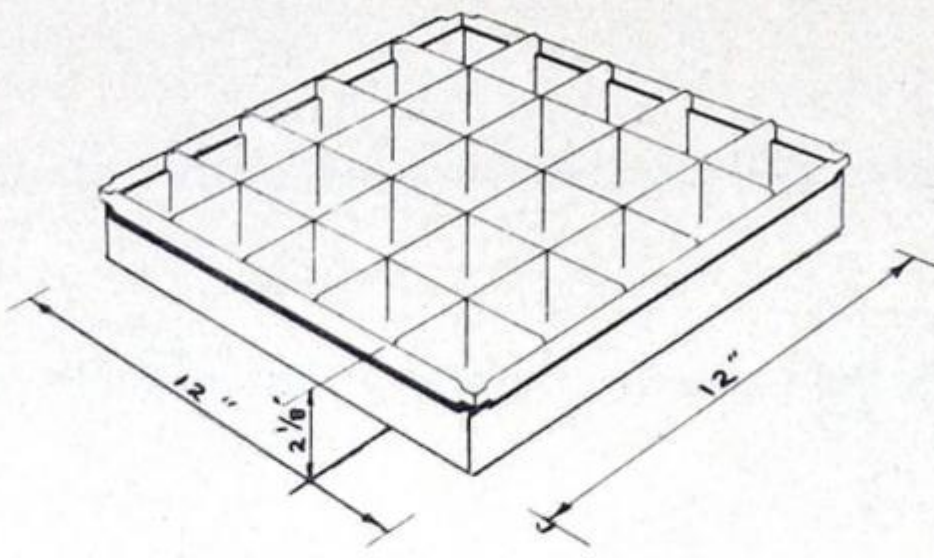

BASIC UNIT

Consists of a square louvered panel of precision moulded styrene plastic, destaticized to prevent dust collection. Each panel weighs 13 ounces and contains 25 cubes which provide 45° lengthwise and crosswise shielding. Luve-Tile comes in white, pink, blue and green. Standard shipping carton contains 12 Tile and a package of joiner clips.

JOINER CLIPS

A simple method of joining basic units into a solid door. Consists of a novel clip, as shown on sketch, that joins top and bottom edge of each separate unit securely, preventing any possibility of sagging or twisting. Because of its very nature, a Luve-Tile installation is always true and symmetrical. To assemble standard size doors, lay basic units together on a flat surface and press clips into notches provided at the corners of each basic unit.

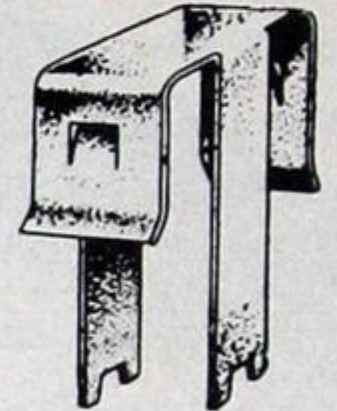
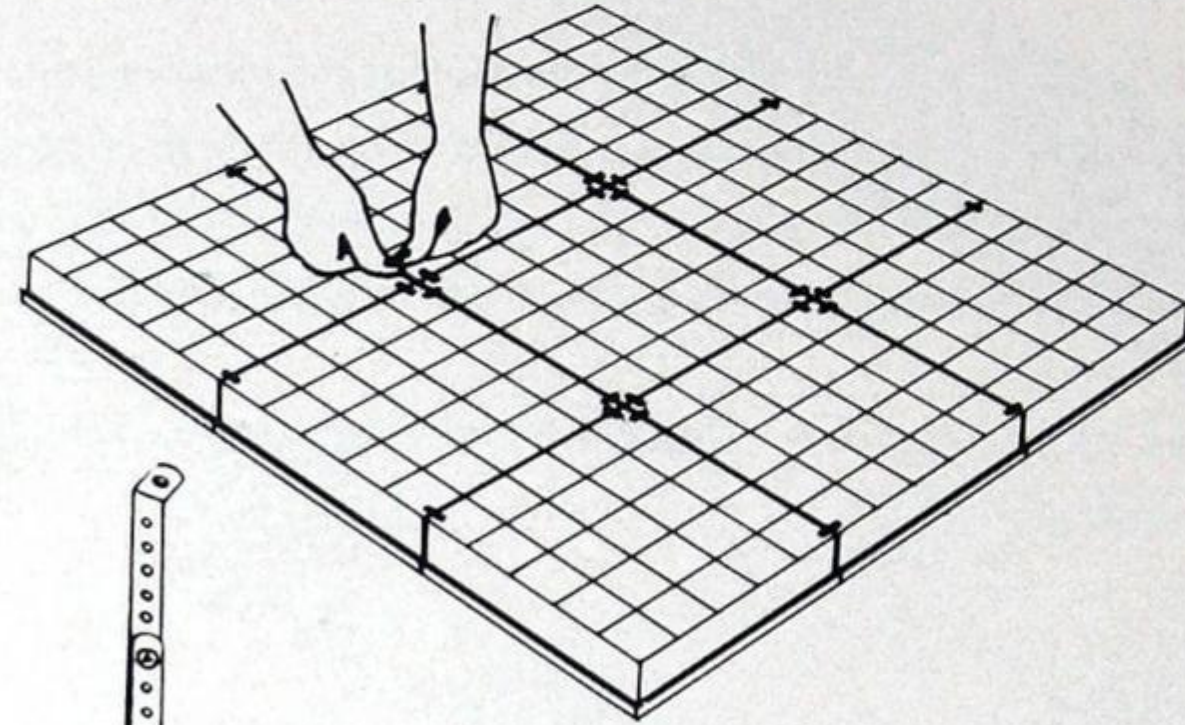

No. 4052

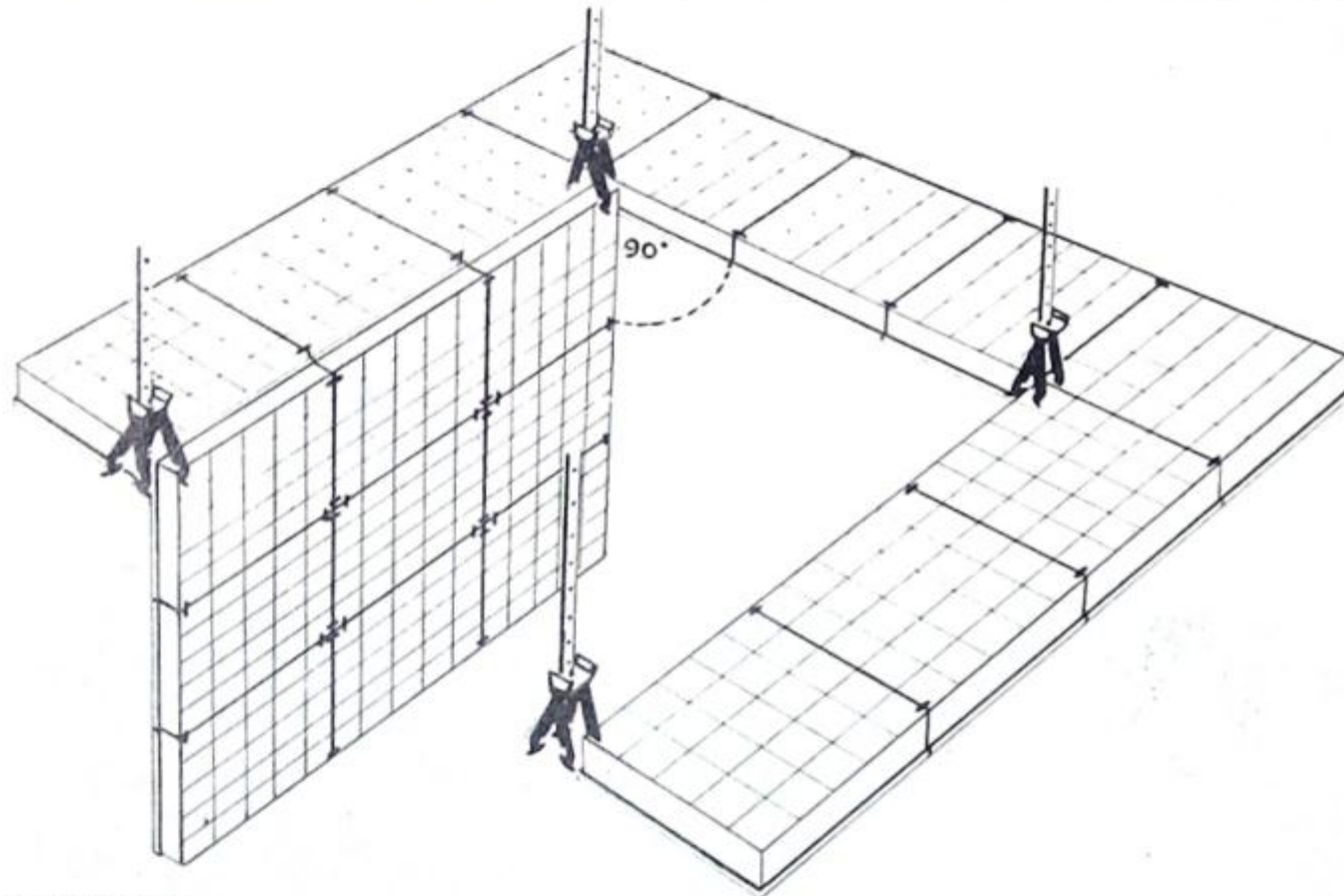

No. 4051A HANGER WITH No. 4054 GRAPPLER BAR



No. 4051B

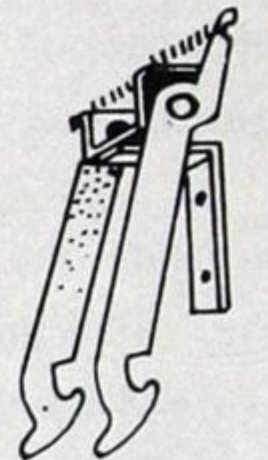

No. 4055

DOORS

Luve-Tile ceilings are composed of independently hinged doors. Recommended sizes are 2'0" x 2'0", 2'0" x 3'0" or 3'0" x 3'0". These doors are secured at each corner by standard hangers as shown in above drawing. Will hinge open independently through 90° and remain hanging in a vertical position to provide ease of relamping fixtures above. Door will then snap back into place and is automatically level.

HANGERS

Exclusive feature of Luve-Tile ceilings. Come in two separate cadmium plated units of 4 hooks and 2 hooks each. Secured to ceiling by means of rods or grapppler bar and holds standard Luve-Tile doors at each outside corner as shown on sketch. Whole ceiling may be levelled accurately by means of an adjustable screw that connects hanger to grapppler bar.

Catalogue No.	Description	Colours Available	Std. Pkg. Contents
4050*	Luve-Tile complete with Joiner Clip Fittings.	White, Green, Blue, Pink	12 sq. ft. Luve-Tile 36 Joiner Clips
4051A	4-hook hanger (centers)	—	4
4051B	2-hook hanger (sides)	—	4
4055	2-hook hanger for side mounting in small cavity	—	4
4054	1-grapppler bar 2 pieces 18" long with 2 fasteners	—	4
4052	Extra joiner clips	—	12
4053	Luve-Tile only—less clips	White, Green, Blue, Pink	12

*Specify number of square feet and colour required. i.e. 100 square feet No. 4050 Luve-Tile, White.



LIGHT AND SOUND CONDITIONING

Curtis Light and Sound Conditioning System

The new Curtis Light and Sound Conditioning System offers an entirely new approach to LIGHTING and SOUND CONDITIONING problems. The system provides quality low-brightness illumination with acoustical treatment which eliminates excessive sound reflections and the annoyances and distractions which sound creates.

THE ELECTRICAL SYSTEM—Standard basic sections of the electrical portion of the Curtis System are supplied completely wired and packaged in 8" x 12" x 96" cartons. Each basic section covers a ceiling area of 256 square feet. Combining the basic sections with extension and wing sections makes it possible to provide quality low-brightness illumination and effective sound treatment.

THE SOUND SYSTEM—The vertical baffles are constructed of highest quality acoustical material with a flame retarding, high reflectance washable finish. The baffles are positioned between the 8 foot, T-12, single pin fluorescent lamps to provide both recommended shielding and sound conditioning.

The Curtis Light and Sound Conditioning System offers the finest in lighting and sound conditioning efficiency from the standpoint of low initial cost, low installation cost, low operating cost and low maintenance cost.

The facilities of the **Northern Electric Lighting Service** are at your disposal for the detailed planning of Light and Sound Conditioning Systems.—

CONSULT YOUR LOCAL NORTHERN ELECTRIC OFFICE

Unit Package of Standard Electrical Section and Installation Procedure.

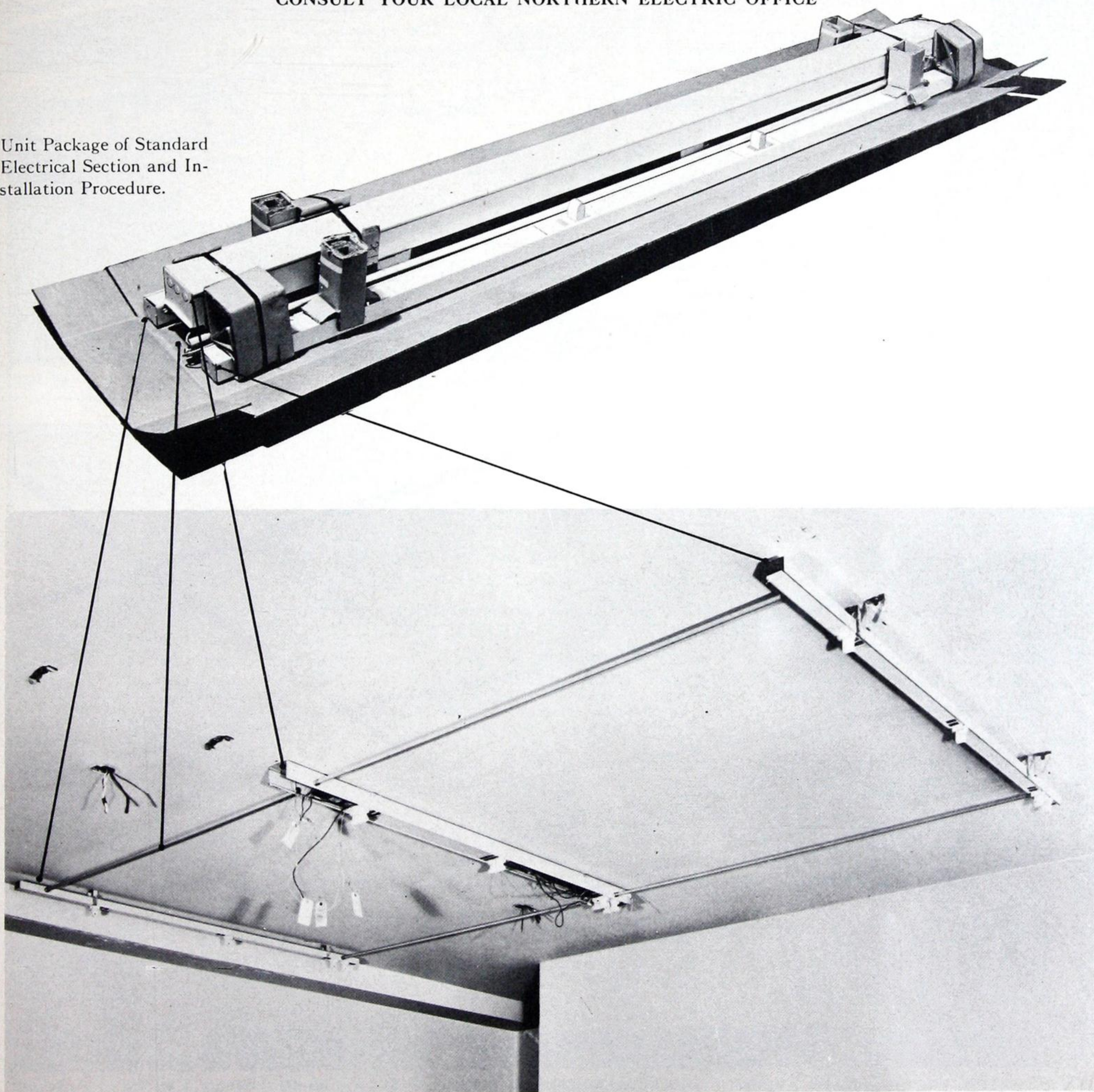



LIGHT AND SOUND CONDITIONING

Curtis Light and Sound Conditioning System

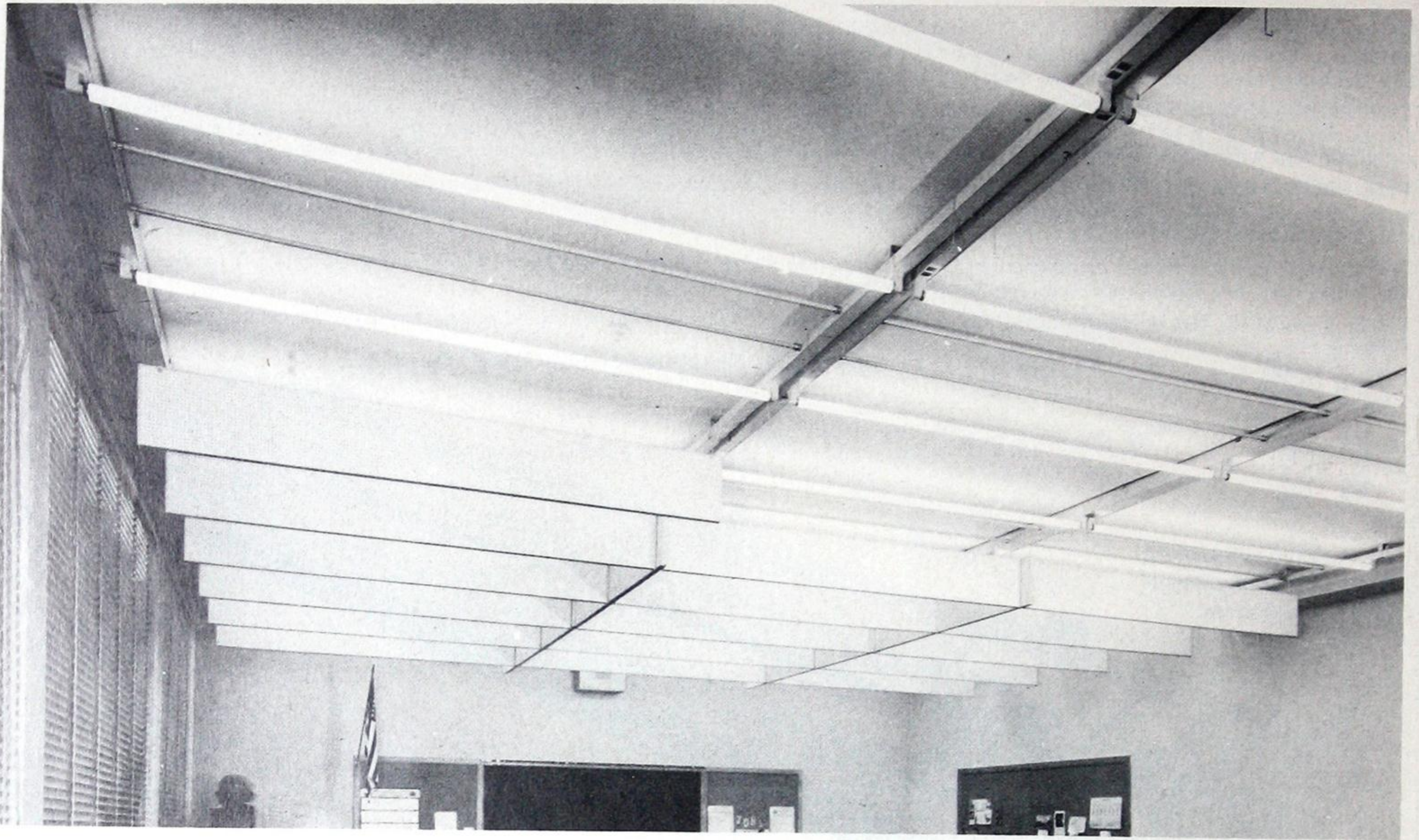

INSTALLATION PARTIALLY COMPLETED

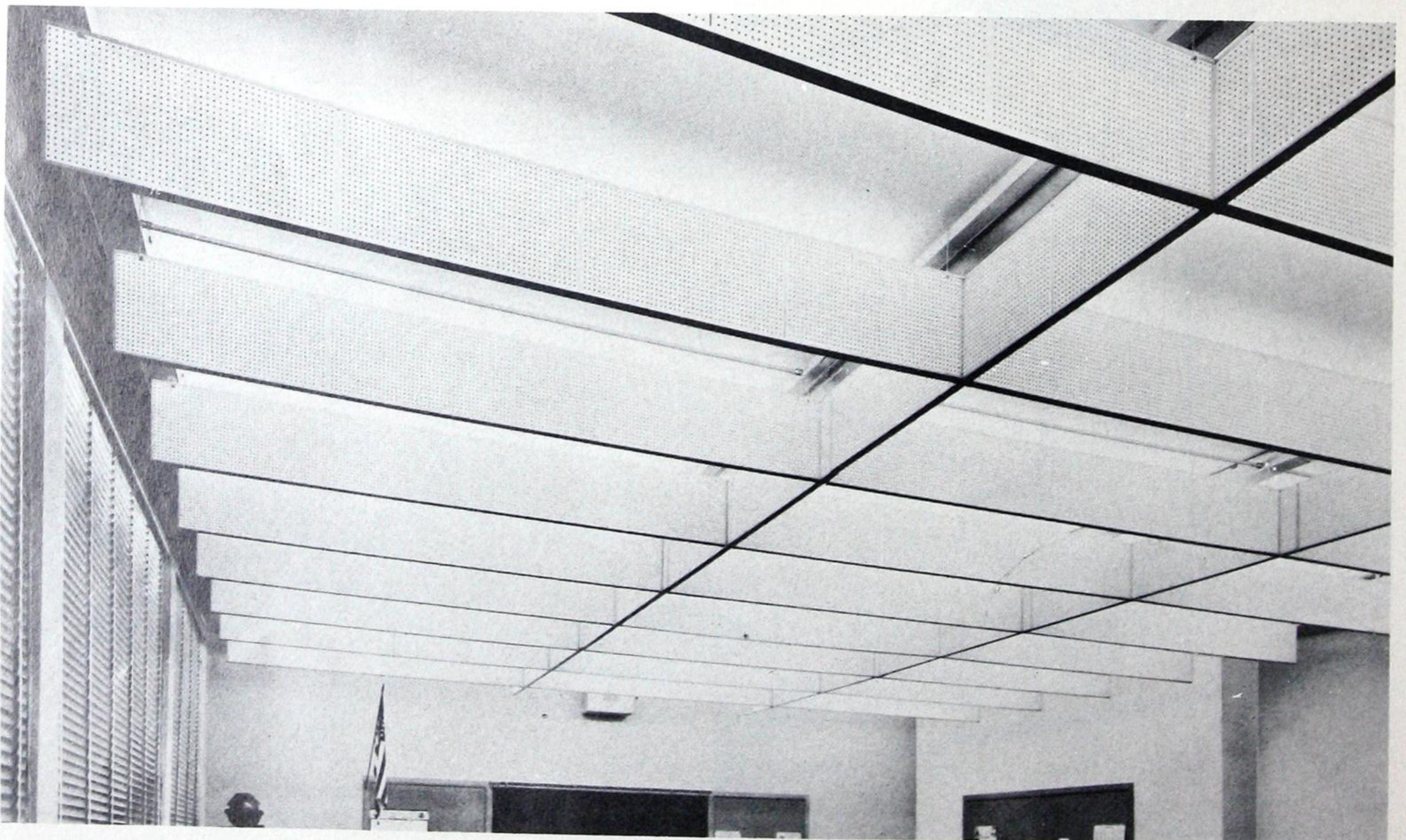

INSTALLATION COMPLETED



FLUORESCENT STRIPLIGHTING UNITS

Standard CurtiStrip

CurtiStrip represents a versatile range of lighting equipment to meet many special lighting applications. It is available without reflector or with a choice of Distributing, Semi-Concentrating or Directional type reflectors. Decorative type units for exposed locations are supplied with ornamental end caps and reflector end plates. Economy type units for concealed installations include plain end caps and no reflector plates. CurtiStrip is available in both basic units and extension sections. Extension sections (see tables below) for fluorescent CurtiStrip permit making up continuous runs with any number of lamps. Basic units come in lengths up to ten feet. When a section more than ten feet is desired, the run is made up with one basic unit and one or more extension sections. The required extension sections should be selected first and the basic unit used to complete the run.

Extension sections are similar to the corresponding basic units except that in place of the end pieces a connector assembly is provided

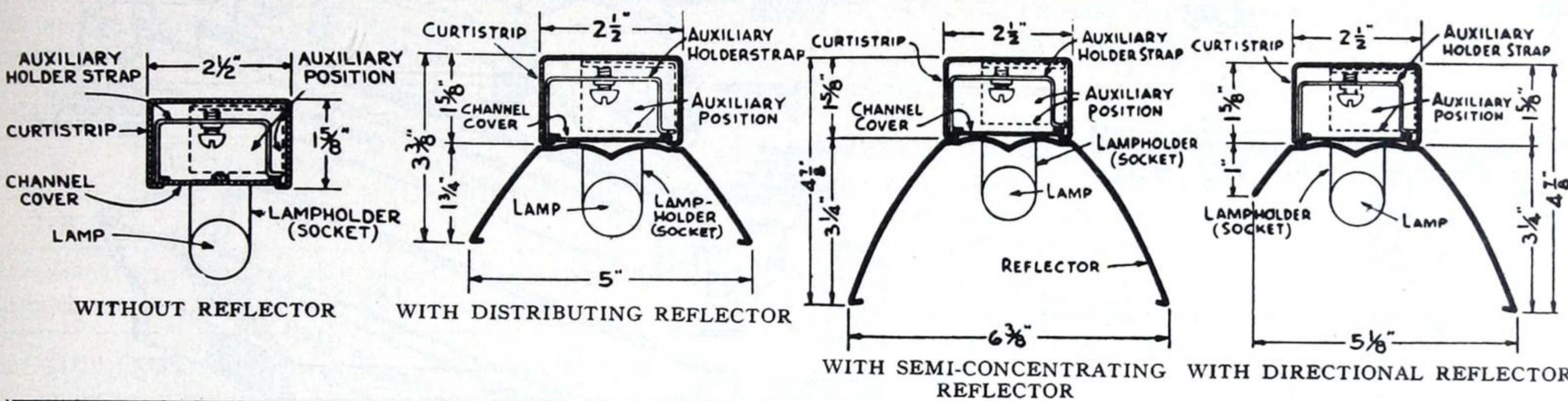

WITHOUT REFLECTOR — Basic Decorative Units											Extension Sections			
Length	1'-6"	2'-0"	3'-0"	4'-0"	4'-0"	6'-0"	6'-0"	8'-0"	8'-0"	9'-0"	10'-0"	8'-0"	9'-0"	10'-0"
Lamps	1 x 15W	1 x 20W	1 x 30W	1 x 40W	2 x 20W	2 x 30W	3 x 20W	2 x 40W	4 x 20W	3 x 30W	5 x 20W	2 x 40W	3 x 30W	5 x 20W
Cat. No.	381-CS	387-CS	391-CS	394-CS	388-CS	392-CS	389-CS	395-CS	390-CS	393-CS	383-CS	395-ECS	393-ECS	383-ECS
WITHOUT REFLECTOR — Basic Economy Units											Extension Sections			
Length	1'-6"	2'-0"	3'-0"	4'-0"	4'-0"	6'-0"	6'-0"	8'-0"	8'-0"	9'-0"	10'-0"	8'-0"	9'-0"	10'-0"
Lamps	1 x 15W	1 x 20W	1 x 30W	1 x 40W	2 x 20W	2 x 30W	3 x 20W	2 x 40W	4 x 20W	3 x 30W	5 x 20W	2 x 40W	3 x 30W	5 x 20W
Cat. No.	444-CS	445-CS	446-CS	447-CS	490-CS	491-CS	492-CS	493-CS	494-CS	495-CS	496-CS	493-ECS	495-ECS	496-ECS
WITH SEMI-CONCENTRATING REFLECTOR — Basic Decorative Units											Extension Sections			
Length	1'-6"	2'-0"	3'-0"	4'-0"	4'-0"	6'-0"	8'-0"	8'-0"	9'-0"	10'-0"		8'-0"	9'-0"	10'-0"
Lamps	1 x 15W	1 x 20W	1 x 30W	1 x 40W	2 x 20W	2 x 30W	2 x 40W	4 x 20W	3 x 30W	5 x 20W		2 x 40W	3 x 30W	5 x 20W
Cat. No.	201-CS	208-CS	212-CS	215-CS	209-CS	213-CS	216-CS	211-CS	214-CS	202-CS		216-ECS	214-ECS	202-ECS
WITH SEMI-CONCENTRATING REFLECTOR — Basic Economy Units											Extension Sections			
Length	1'-6"	2'-0"	3'-0"	4'-0"	4'-0"	6'-0"	8'-0"	8'-0"	9'-0"	10'-0"		8'-0"	9'-0"	10'-0"
Lamps	1 x 15W	1 x 20W	1 x 30W	1 x 40W	2 x 20W	2 x 30W	2 x 40W	4 x 20W	3 x 30W	5 x 20W		2 x 40W	3 x 30W	5 x 20W
Cat. No.	427-CS	428-CS	429-CS	430-CS	411-CS	412-CS	413-CS	414-CS	415-CS	416-CS		413-ECS	415-ECS	416-ECS
WITH DISTRIBUTING REFLECTOR — Basic Decorative Units											Extension Sections			
Length	1'-6"	2'-0"	3'-0"	4'-0"	4'-0"	6'-0"	8'-0"	8'-0"	9'-0"	10'-0"		8'-0"	9'-0"	10'-0"
Lamps	1 x 15W	1 x 20W	1 x 30W	1 x 40W	2 x 20W	2 x 30W	2 x 40W	4 x 20W	3 x 30W	5 x 20W		2 x 40W	3 x 30W	5 x 20W
Cat. No.	327-CS	333-CS	337-CS	341-CS	334-CS	339-CS	342-CS	336-CS	340-CS	328-CS		342-ECS	340-ECS	328-ECS
WITH DISTRIBUTING REFLECTOR — Basic Economy Units											Extension Sections			
Length	1'-6"	2'-0"	3'-0"	4'-0"	4'-0"	6'-0"	8'-0"	8'-0"	9'-0"	10'-0"		8'-0"	9'-0"	10'-0"
Lamps	1 x 15W	1 x 20W	1 x 30W	1 x 40W	2 x 20W	2 x 30W	2 x 40W	4 x 20W	3 x 30W	5 x 20W		2 x 40W	3 x 30W	5 x 20W
Cat. No.	432-CS	433-CS	434-CS	435-CS	454-CS	455-CS	456-CS	457-CS	458-CS	459-CS		456-ECS	458-ECS	459-ECS
WITH DIRECTIONAL REFLECTOR — Basic Decorative Units											Extension Sections			
Length	1'-6"	2'-0"	3'-0"	4'-0"	4'-0"	6'-0"	8'-0"	8'-0"	9'-0"	10'-0"		8'-0"	9'-0"	10'-0"
Lamps	1 x 15W	1 x 20W	1 x 30W	1 x 40W	2 x 20W	2 x 30W	2 x 40W	4 x 20W	3 x 30W	5 x 20W		2 x 40W	3 x 30W	5 x 20W
Cat. No.	292-CS	298-CS	302-CS	306-CS	299-CS	304-CS	308-CS	301-CS	305-CS	293-CS		308-ECS	305-ECS	293-ECS
WITH DIRECTIONAL REFLECTOR — Basic Economy Units											Extension Sections			
Length	1'-6"	2'-0"	3'-0"	4'-0"	4'-0"	6'-0"	8'-0"	8'-0"	9'-0"	10'-0"		8'-0"	9'-0"	10'-0"
Lamps	1 x 15W	1 x 20W	1 x 30W	1 x 40W	2 x 20W	2 x 30W	2 x 40W	4 x 20W	3 x 30W	5 x 20W		2 x 40W	3 x 30W	5 x 20W
Cat. No.	437-CS	438-CS	439-CS	442-CS	464-CS	465-CS	466-CS	467-CS	468-CS	469-CS		466-ECS	468-ECS	469-ECS



FLUORESCENT STRIPLIGHTING UNITS

Standard CurtiStrip

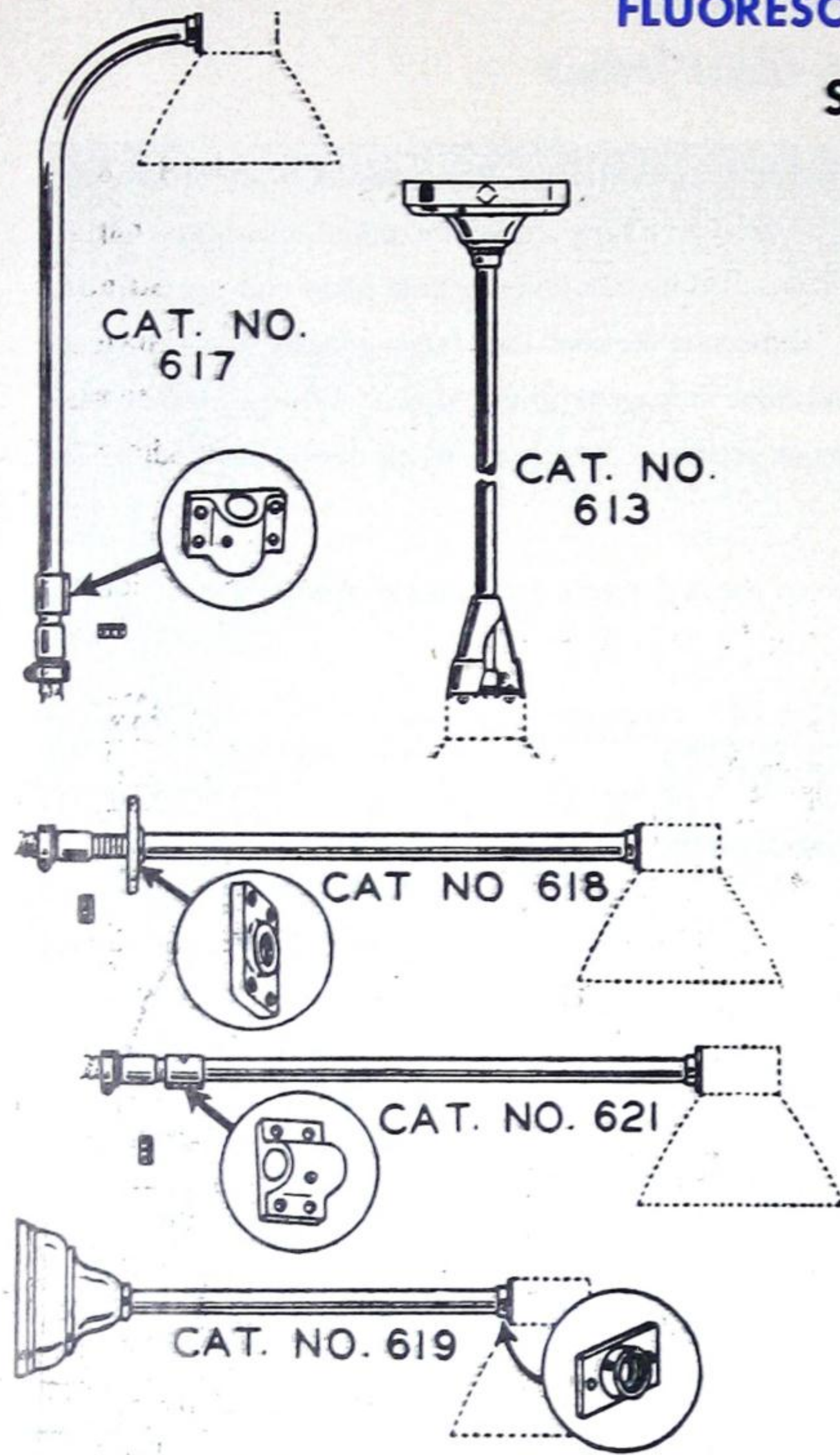

SUPPORTS AND HANGERS

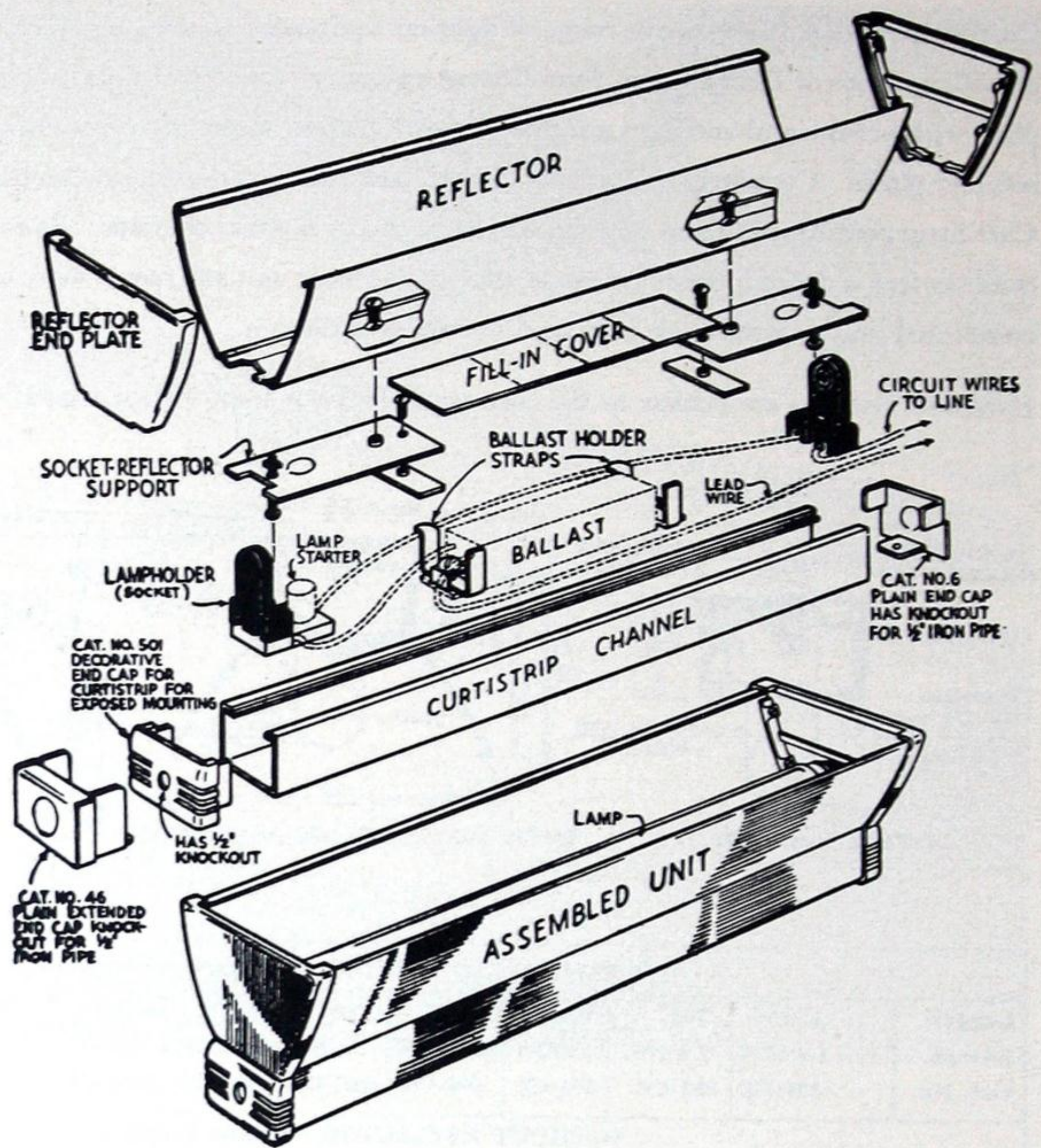

CURTISTRIP PARTS

CURVED ARM PEDESTAL TYPE

Mounting height above table is adjustable to a maximum of 18 inches to top of CurtiStrip. Uprights should be spaced not more than 6 feet apart.

Cat. No. 617. For mounting to top edges of table, case or counter. Connects to side of CurtiStrip. Includes 3/8-inch iron pipe connector, flexible conduit connector, and bushing for cord connection. Two or three brackets are suggested for each fixture up to 10 feet.

Cat. No. 620—with angle fitting. Same as No. 617 except that it connects to CurtiStrip end casting (Cat. No. 501).

SELF-ALIGNING-PENDENT SUPPORTS

Cat. No. 613. For mounting to outlet box in ceiling for direct lighting only. Use two supports for each section of Fluorescent CurtiStrip up to 10 feet. Lower end of hanger bolts to back channel.

Standard suspension is 40 inches to top of CurtiStrip. May be cut to any shorter length without threading. If longer suspension is desired, it can be supplied if specified.

Cat. No. 614—with angle fitting. For mounting to outlet box in ceiling for direct or indirect lighting. Suspension 21 inches to top of CurtiStrip.

HORIZONTAL OR PEDESTAL SUPPORTS

Finished pipe included in these supports has a standard length of 18 inches. In horizontal position, supports permit use of Fluorescent CurtiStrip for direct or indirect lighting. Brackets should be spaced not more than 6 feet apart.

Cat. No. 615—with angle fitting. For mounting on walls, tables, counters, wall cases, etc. Includes 3/8-inch iron pipe connector, flexible conduit connector and bushing for cord connection.

Cat. No. 616—with angle fitting. For mounting to outlet box in wall or other vertical surfaces. Slip-ring style canopy.

Cat. No. 618. For mounting on walls, wall cases or other vertical surfaces. Connects to side of CurtiStrip channel. Includes 3/8-inch iron pipe connector, flexible conduit connector, and bushing for cord connection. One mounting bracket is suggested for each 18-inch or 24-inch section; two for longer sections.

Cat. No. 619. For mounting to outlet box in wall or other vertical surfaces. Connects to side of CurtiStrip channel. Includes slip-ring style canopy. One mounting bracket is suggested for each 18-inch or 24-inch section; two for longer sections.

Cat. No. 621. Similar to No. 618 except for mounting on top surface of wall case or other horizontal surfaces. Extension is adjustable.

Cat. No. 622—with angle fitting. Similar to No. 615 except for mounting on top surface of wall case or side of table or counter. Extension adjustable without cutting pipe.



FLUORESCENT STRIPLIGHTING UNITS

Standard CurtiStrip

For cases where unusual requirements demand individual solution, CurtiStrip offers an ordering program which enables the contractor to construct from stock parts "Custom-made" Fluorescent CurtiStrip fixtures which will exactly fit every Fluorescent lighting need. "Custom-made" fixtures are desirable and economical for special lighting problems or for installations where plain finished parts may be used.

With each "Custom-made" fixture the following parts are needed:

1. CURTISTRIP CHANNEL. For length of channel required, add together the nominal lamp lengths. For example, two 36-inch lamps require 72 inches of CurtiStrip. No additional channel need be provided for end caps, reflectors, or for reflector end plates. Channel and cover are made of 20-gauge cold-rolled steel, size 2½ inches wide and 1⅝ inches deep. Holes are provided at the end of each length to facilitate attachment of end caps or couplings.

Cat. No.*	Description	Length	Std. Pkg.
1	Channel with cover.	10'	10 lengths
1-A	Channel only.	10'	10 lengths
1-B	Cover only.	10'	10 lengths

*Economy type—rust-resisting plated. Decorative type with satin silvertone finish can be supplied if specified.

2. COUPLINGS. For continuous runs with more than one section of CurtiStrip, order one No. 16 coupling for every joint in channel section. To avoid screw heads showing on the back of CurtiStrip, order also two No. 181 holder straps to clamp coupling to channel.

3. BALLAST HOLDER STRAPS. Two No. 181 straps should be used when a ballast or compensator is clamped in CurtiStrip.

4. SOCKET-REFLECTOR SUPPORTS. Pair of supports (Cat. No. 787) are necessary for each lamp section of the fixture. The same set of supports is used with all size lamps.

Cat No.	Finish	Std. Pkg.
787	Aluminum	10 sets

5. FILL-IN COVER. When no reflector is used, fill-in cover is necessary to close the space between the two socket-reflector supports. Where a reflector is used with the lamp, no fill-in cover is needed, because the bottom of the reflector itself closes the spaces between the two socket-reflector supports.

To close the space between the two socket-reflector supports (each support is 4½ inches long), when reflectors are not used on fixtures, fill-in cover is required in the following lengths, depending on size lamp used:

- 9 inches for 15-watt lamp.
- 15 inches for 20-watt lamp.
- 27 inches for 30-watt lamp.
- 39 inches for 40-watt lamp.

Cat. No.	Length	Description	Std. Pkg.
1-B	10'	Rust-resisting Plated	10 lengths
797	39"	Satin Silvertone	20 lengths

6. CURTISTRIP END CAPS Two end caps per fixture are required to close the ends of channel sections. There are two general types available: decorative and plain.

No. 501, Decorative End Cap, finished Satin Silvertone gives a finished appearance and provides means of support where fixture is suspended from ends of channel with hangers using angle fittings.

Nos. 6 and 46, Plain End Caps, are rust-resisting plated. Use No. 46 where wire connection is made through end of CurtiStrip and Fluorescent socket is to be even with end of channel.

Cat. No.	Description	Std. Pkg.
501*	Decorative End Cap	10
6**	Plain End Cap	10
46**	Extended End Cap which extends ⅝ inches beyond end of channel.	10

*Finished Satin Silvertone. **Rust-resisting Plated Finish.

7. REFLECTORS. One reflector per lamp is required. Reflectors may be mounted on CurtiStrip with or without reflector end plates with any desired spacing between units. All reflectors are of steel with Fluracite finish.

The reflectors used with Fluorescent CurtiStrip are carefully designed to take maximum advantage of the high efficiency of the fluorescent lamp. The variety of reflector shapes available ensure the correct distribution for every application.

Cat. No.	Length	Type	Std. Pkg.
102-S	18"	Semi-concentrating	10
103-S	24"	Semi-concentrating	10
104-S	36"	Semi-concentrating	10
105-S	48"	Semi-concentrating	10
106-S	18"	Directional	10
107-S	24"	Directional	10
108-S	36"	Directional	10
109-S	48"	Directional	10
114-S	18"	Distributing	10
115-S	24"	Distributing	10
116-S	36"	Distributing	10
117-S	48"	Distributing	10

8. REFLECTOR END PLATES. These die-cast end plates close the ends of reflectors, hold reflectors rigid and harmonize with CurtiStrip end caps. Two reflector end plates per fixture or run recommended to close reflector ends. Satin silvertone finish.

Cat. No.	Type	Std. Pkg.
502	Deep Symmetrical	10
503	Shallow Symmetrical	10
504	Asymmetrical (right end)	10
505	Asymmetrical (left end)	10

9. REFLECTOR CONNECTORS. In continuous runs of all types of reflector assemblies between reflectors, connectors should be used to cover reflector joint. The connector is a soft metal strap which fits over two adjoining sockets and is bent over reflector, making a neat join and preventing light leakage. No. 129 connector is used with all types of reflectors.

10. No. 32 FITTING. Where it is desired to suspend fluorescent luminaires from CurtiStrip the No. 32 fitting may be used. Fewer hangers and outlets are required, and perfectly aligned rows are assured.



FLUORESCENT AND SLIMLINE STRIPLIGHTING UNITS

Mogul CurtiStrip

Mogul Fluorescent CurtiStrip is the most versatile line of lighting equipment ever offered for exposed-to-view or concealed lighting applications. The cold-roll steel wire channel is large enough to accommodate ballasts for operating all Slimline, Starter Type, and Low Brightness Fluorescent Lamps. It is 5 1/8" wide by 2 7/8" deep and is available in 4 foot, 5 foot, 6 foot, 8 foot, 10 foot, 12 foot and 16 foot lengths. Continuous lines of any length can be made by the use of a sturdy, steel channel coupling.

Mogul Fluorescent CurtiStrip Parts

In order to permit greater flexibility in field applications, all parts which go to make a complete fluorescent unit may be purchased separately. This enables the electrical contractor to construct "Custom-Made" Fluorescent Units on the job.

Materials and Finishes

Mogul CurtiStrip is available in two finishes:

1. Decorative Type—For exposed-to-view application. All component parts constructed of heavy gauge steel. Wire Channel and End Plates finished Baked Grey Enamel. Lampholder mounting plates and fill-in cover finished "Baked White Fluracite".
2. Economy Type—For industrial areas, above louver and luminous ceilings, and other locations where finish is not a primary consideration, such as Cove Lighting. All component parts constructed of heavy gauge steel. Wire Channel, End Plates, Lampholder, Mounting Plates and Fill-In Cover finished in durable rust-proof zinc.

Basic and Extension Units

Where Mogul Fluorescent Curtistrip is to be installed in continuous lines, order one basic unit for each line and fill out remainder of run with extension units. Both basic and extension units are supplied completely wired with High Power ballasts. Basic units are supplied with two end caps. Extension units are supplied without end caps but include a sturdy steel channel coupling which permits joining units end to end quickly and economically. Units for pre-heat type fluorescent lamps are supplied less starters.

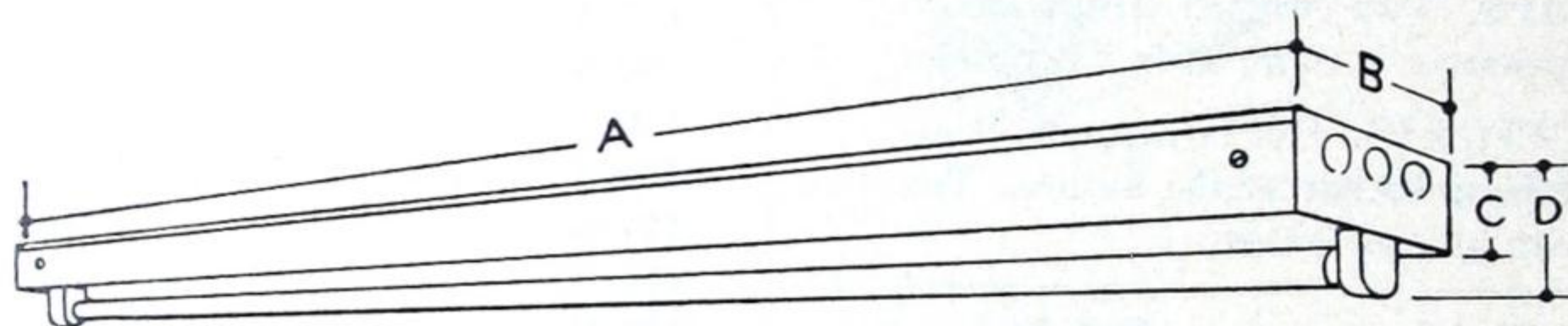

SINGLE LAMP WIRED UNITS

BASIC SINGLE LAMP WIRED UNITS*—DECORATIVE TYPE

Catalogue No.	Lamps	Dimensions			
		A	B	C	D
1201-C4	1 x 36W T12, 48" Slimline	48 1/8"	5 1/8"	2 7/8"	4 5/8"
1202-C5**	1 x 85W T17, 60" Fluorescent	60 1/8"	5 1/8"	2 7/8"	5 1/4"
1203-C5	1 x 40W T17, 60" Low Brightness Fluorescent	60 1/8"	5 1/8"	2 7/8"	5 1/4"
1204-C6	1 x 54W T12, 72" Slimline	72 1/8"	5 1/8"	2 7/8"	4 5/8"
1205-C8	1 x 72W T12, 96" Slimline	96 1/8"	5 1/8"	2 7/8"	4 5/8"
1206-C4**	1 x 40W T12, 48" Fluorescent	48 1/8"	5 1/8"	2 7/8"	4 5/8"

*For extension units for above—see Extension Units for 2 lamps in line, next page.

**Require starters—starters not supplied.

BASIC SINGLE LAMP WIRED UNITS*—ECONOMY TYPE

Catalogue No.	Lamps	Dimensions			
		A	B	C	D
1301-C4	1 x 36W T12, 48" Slimline	48 1/8"	5 1/8"	2 7/8"	4 5/8"
1302-C5**	1 x 85W T17, 60" Fluorescent	60 1/8"	5 1/8"	2 7/8"	5 1/4"
1303-C5	1 x 40W T17, 60" Low Brightness Fluorescent	60 1/8"	5 1/8"	2 7/8"	5 1/4"
1304-C6	1 x 54W T12, 72" Slimline	72 1/8"	5 1/8"	2 7/8"	4 5/8"
1305-C8	1 x 72W T12, 96" Slimline	96 1/8"	5 1/8"	2 7/8"	4 5/8"
1306-C4**	1 x 40W T12, 48" Fluorescent	48 1/8"	5 1/8"	2 7/8"	4 5/8"

*For extension units for above—see Extension Units for 2 lamps in line, next page.

**Require Starters—Starters not supplied.



FLUORESCENT AND SLIMLINE STRIPLIGHTING UNITS

Mogul CurtiStrip

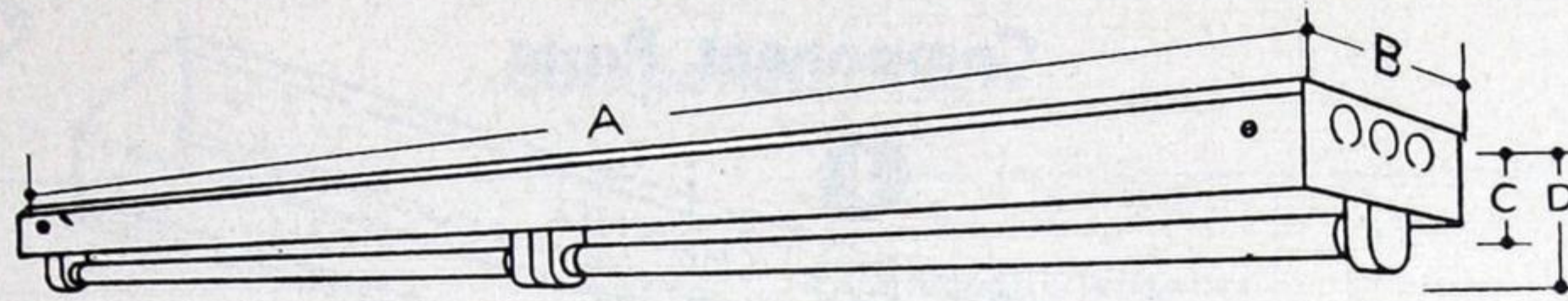

2 LAMP IN-LINE WIRED UNITS

BASIC AND EXTENSION 2 LAMP IN-LINE WIRED UNITS—DECORATIVE TYPE

Catalogue No.		Lamps	Dimensions				
Basic Units	Extension Sections		Basic A	Extension A	B	C	D
1201-C8	1201-CE8	2 x 36W T12, 48" Slimline	96 ¹ / ₈ "	96"	5 ¹ / ₈ "	2 ⁷ / ₈ "	4 ⁵ / ₈ "
1202-C10*	1202-CE10*	2 x 85W T17, 60" Fluorescent	120 ¹ / ₈ "	120"	5 ¹ / ₈ "	2 ⁷ / ₈ "	5 ¹ / ₄ "
1203-C10	1203-CE10	2 x 40W T17, 60" Low Brightness Fluorescent	120 ¹ / ₈ "	120"	5 ¹ / ₈ "	2 ⁷ / ₈ "	5 ¹ / ₄ "
1204-C12	1204-CE12	2 x 54W T12, 72" Slimline	144 ¹ / ₈ "	144"	5 ¹ / ₈ "	2 ⁷ / ₈ "	4 ⁵ / ₈ "
1205-C16	1205-CE16	2 x 72W T12, 96" Slimline	192 ¹ / ₈ "	192"	5 ¹ / ₈ "	2 ⁷ / ₈ "	4 ⁵ / ₈ "
1206-C8*	1206-CE8*	2 x 40W T12, 48" Fluorescent	96 ¹ / ₈ "	96"	5 ¹ / ₈ "	2 ⁷ / ₈ "	4 ⁵ / ₈ "

*Require starters—starters not supplied.

BASIC AND EXTENSION 2 LAMP IN-LINE WIRED UNITS—ECONOMY TYPE

Catalogue No.		Lamps	Dimensions				
Basic Units	Extension Sections		Basic A	Extension A	B	C	D
1301-C8	1301-CE8	2 x 36W T12, 48" Slimline	96 ¹ / ₈ "	96"	5 ¹ / ₈ "	2 ⁷ / ₈ "	4 ⁵ / ₈ "
1302-C10*	1302-CE10*	2 x 85W T17, 60" Fluorescent	120 ¹ / ₈ "	120"	5 ¹ / ₈ "	2 ⁷ / ₈ "	5 ¹ / ₄ "
1303-C10	1303-CE10	2 x 40W T17, 60" Low Brightness Fluorescent	120 ¹ / ₈ "	120"	5 ¹ / ₈ "	2 ⁷ / ₈ "	5 ¹ / ₄ "
1304-C12	1304-CE12	2 x 54W T12, 72" Slimline	144 ¹ / ₈ "	144"	5 ¹ / ₈ "	2 ⁷ / ₈ "	4 ⁵ / ₈ "
1305-C16	1305-CE16	2 x 72W T12, 96" Slimline	192 ¹ / ₈ "	192"	5 ¹ / ₈ "	2 ⁷ / ₈ "	4 ⁵ / ₈ "
1306-C8*	1306-CE8*	2 x 40W T12, 48" Fluorescent	96 ¹ / ₈ "	96"	5 ¹ / ₈ "	2 ⁷ / ₈ "	4 ⁵ / ₈ "

*Require starters—starters not supplied.

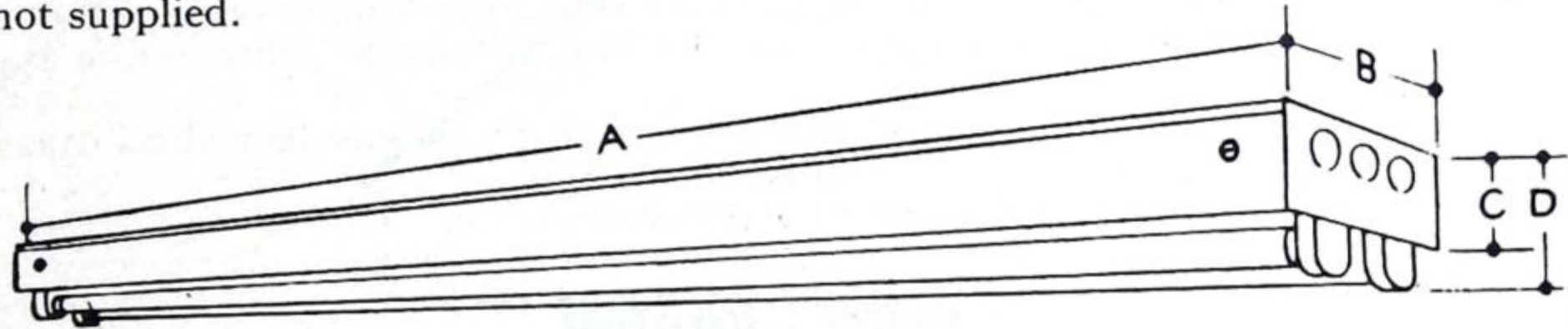

TWIN LAMP WIRED UNITS

BASIC AND EXTENSION TWIN LAMP WIRED UNITS—DECORATIVE TYPE

Catalogue No.		Lamps	Dimensions				
Basic Units	Extension Sections		Basic A	Extension A	B	C	D
1213-C4	1213-CE4	2 x 36W T12, 48" Slimline	48 ¹ / ₈ "	48"	5 ¹ / ₈ "	2 ⁷ / ₈ "	4 ⁵ / ₈ "
1214-C5*	1214-CE5*	2 x 85W T17, 60" Fluorescent	60 ¹ / ₈ "	60"	5 ¹ / ₈ "	2 ⁷ / ₈ "	5 ¹ / ₄ "
1215-C5	1215-CE5	2 x 40W T17, 60" Low Brightness Fluorescent	60 ¹ / ₈ "	60"	5 ¹ / ₈ "	2 ⁷ / ₈ "	5 ¹ / ₄ "
1216-C6	1216-CE6	2 x 54W T12, 72" Slimline	72 ¹ / ₈ "	72"	5 ¹ / ₈ "	2 ⁷ / ₈ "	4 ⁵ / ₈ "
1217-C8	1217-CE8	2 x 72W T12, 96" Slimline	96 ¹ / ₈ "	96"	5 ¹ / ₈ "	2 ⁷ / ₈ "	4 ⁵ / ₈ "
1212-C4*	1212-CE4*	2 x 40W T12, 48" Fluorescent	48 ¹ / ₈ "	48"	5 ¹ / ₈ "	2 ⁷ / ₈ "	4 ⁵ / ₈ "

*Require starters—starters not supplied.

BASIC AND EXTENSION TWIN LAMP WIRED UNITS—ECONOMY TYPE

Catalogue No.		Lamps	Dimensions				
Basic Units	Extension Sections		Basic A	Extension A	B	C	D
1313-C4	1313-CE4	2 x 36W T12, 48" Slimline	48 ¹ / ₈ "	48"	5 ¹ / ₈ "	2 ⁷ / ₈ "	4 ⁵ / ₈ "
1314-C5*	1314-CE5*	2 x 85W T17, 60" Fluorescent	60 ¹ / ₈ "	60"	5 ¹ / ₈ "	2 ⁷ / ₈ "	5 ¹ / ₄ "
1315-C5	1315-CE5	2 x 40W T17, 60" Low Brightness Fluorescent	60 ¹ / ₈ "	60"	5 ¹ / ₈ "	2 ⁷ / ₈ "	5 ¹ / ₄ "
1316-C6	1316-CE6	2 x 54W T12, 72" Slimline	72 ¹ / ₈ "	72"	5 ¹ / ₈ "	2 ⁷ / ₈ "	4 ⁵ / ₈ "
1317-C8	1317-CE8	2 x 72W T12, 96" Slimline	96 ¹ / ₈ "	96"	5 ¹ / ₈ "	2 ⁷ / ₈ "	4 ⁵ / ₈ "
1312-C4*	1312-CE4*	2 x 40W T12, 48" Fluorescent	48 ¹ / ₈ "	48"	5 ¹ / ₈ "	2 ⁷ / ₈ "	4 ⁵ / ₈ "

*Require starters—starters not supplied.



FLUORESCENT AND SLIMLINE STRIPLIGHTING UNITS

Mogul CurtiStrip

Component Parts

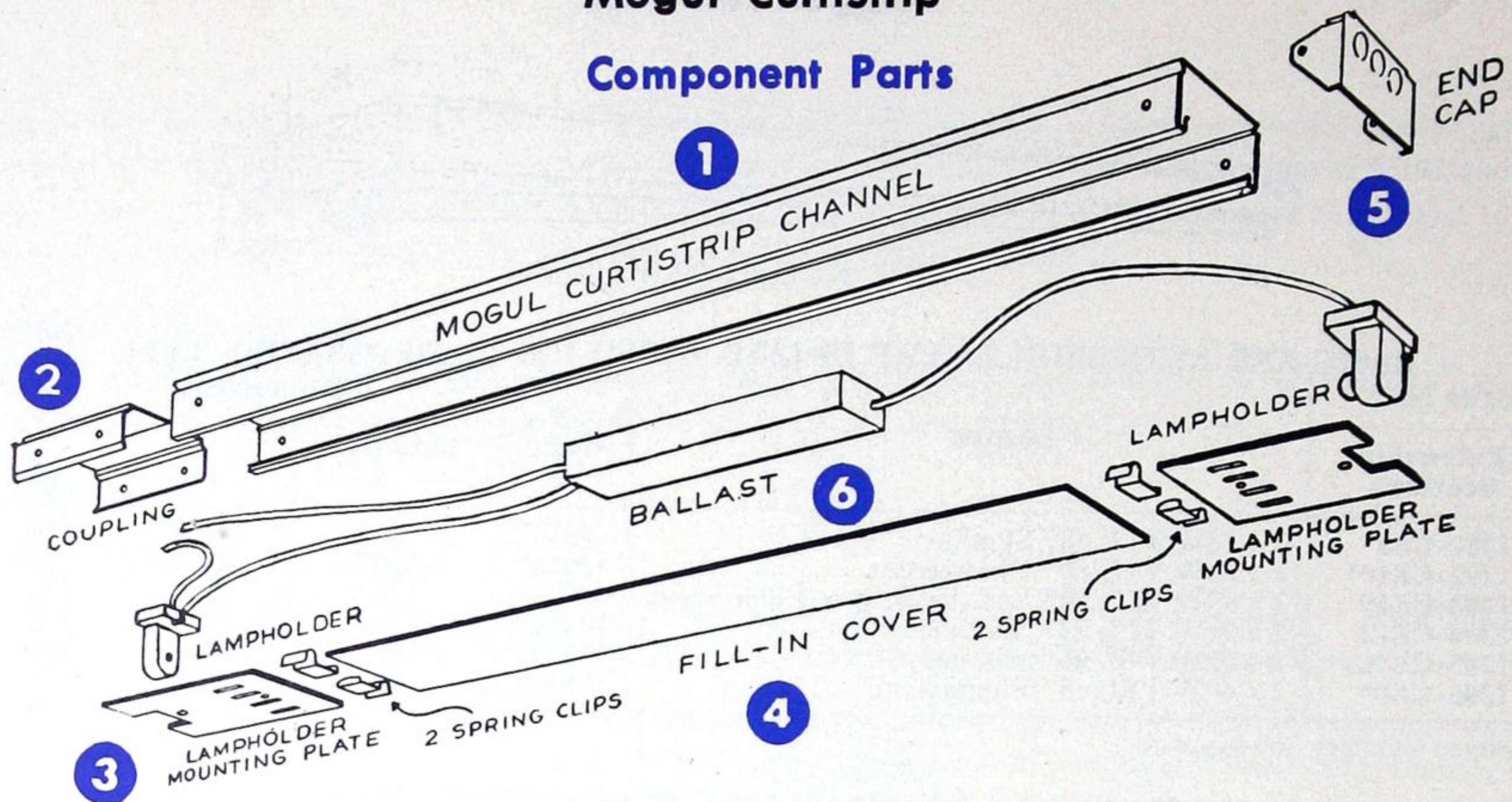

All component parts which go to make up a complete Mogul Fluorescent CurtiStrip unit may be ordered separately. This enables the contractor to construct "custom-made" units from stock parts. To be certain all necessary parts have been ordered to assemble a complete unit or continuous line of units check the list below.

1. Mogul CurtiStrip Wire Channel. To determine length of channel required, add together the nominal lamp lengths. For example, four 48-inch lamps require sixteen feet of Mogul CurtiStrip wire channel. Wire Channel is available in two finishes: baked grey enamel (decorative type) and rust proof zinc-grip (economy type).
2. Coupling. For continuous lines utilizing more than one section of Mogul CurtiStrip, order one coupling for every joint in the channel section.
3. Lampholder Mounting Plates. There is a lampholder mounting plate available to accommodate sockets for all T-8, T-12 and T-17 fluorescent and slimline lamps. Mounting Plates are available in two finishes: baked white "Fluracite" (decorative type) and rust proof zinc-grip (economy type).
4. Fill-in Cover. Used to close wire channel between lampholder mounting plates. One foot less of fill-in cover is required than the nominal lamp length. Examples: Units using 4-foot lamps require a 3-foot section of fill-in cover; 5-foot units, require a 4-foot section of fill-in cover, etc. Fill-in cover is available in two finishes: baked white "Fluracite" (decorative type) and rust proof zinc-grip (economy type).
5. End Caps. Two end caps are required for each individual unit or for each continuous line. End caps are available in two finishes: baked grey enamel (decorative type) and rust proof zinc-grip (economy type).
6. For information on ballasts and lampholders refer fluorescent accessories section.

Wire Channel

Cat. No.		Description	Dimensions		
Decorative	Economy		Length	Width	Depth
1104	1004	4' Wire Channel Only	48"	5 1/8"	2 7/8"
1105	1005	5' Wire Channel Only	60"	5 1/8"	2 7/8"
1106	1006	6' Wire Channel Only	72"	5 1/8"	2 7/8"
1108	1008	8' Wire Channel Only	96"	5 1/8"	2 7/8"
1101	1001	10' Wire Channel Only	120"	5 1/8"	2 7/8"
1100	1000	10' Wire Channel with Cover	120"	5 1/8"	2 7/8"

Cover Only

Catalogue No.		Description	Dimensions	
Decorative	Economy		Length	Width
1195	1095	3' Cover for making 4' units	36"	4 3/4"
1196	1096	4' Cover for making 5' units	48"	4 3/4"
1197	1097	5' Cover for making 6' units	60"	4 3/4"
1198	1098	7' Cover for making 8' units	84"	4 3/4"
1199	1099	10' Cover for use with wire channel when used as Raceway	120"	4 3/4"



FLUORESCENT AND SLIMLINE STRIPLIGHTING UNITS

Mogul CurtiStrip

Component Parts

Catalogue Number		END CAP
Decorative	Economy	Description
1126	1026	For closing Ends of Wire Channel

Catalogue Number		COUPLING
		Description
1016		For Joining Wire Channels end to end

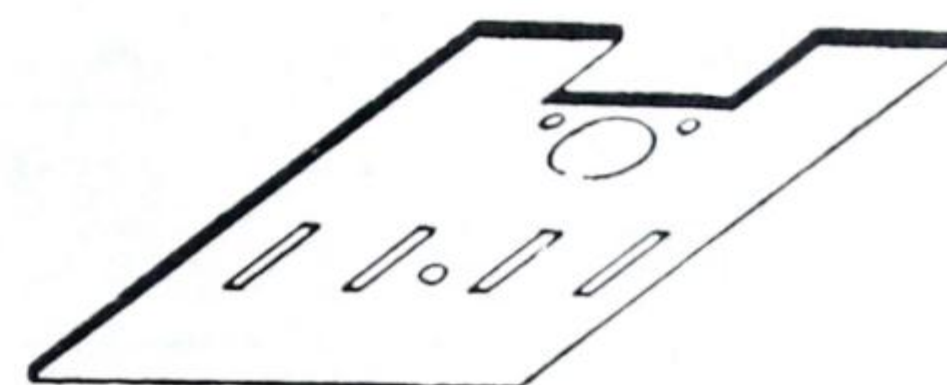
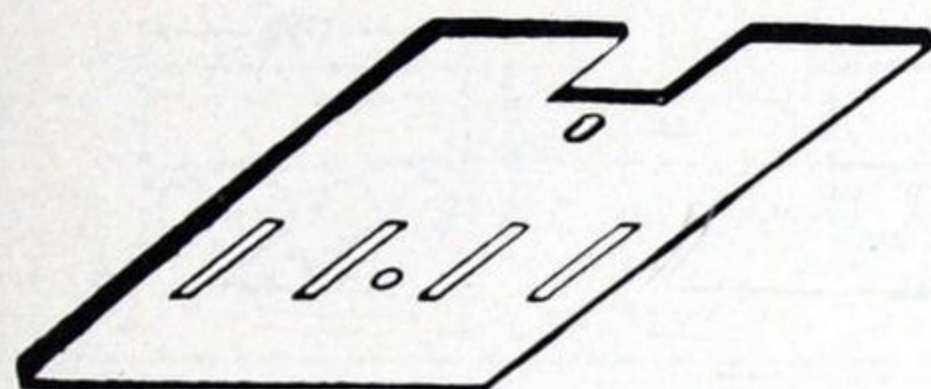

Single Lamp Slimline Lampholder Plates Catalogue Number*	
Decorative	Economy
1180	1080

Single Lamp Medium Bi-Pin Lampholder Plates Catalogue No.*	
Decorative	Economy
1181	1081

Single Lamp Mogul Bi-Pin Lampholder Plates Catalogue No.*	
Decorative	Economy
1182	1082

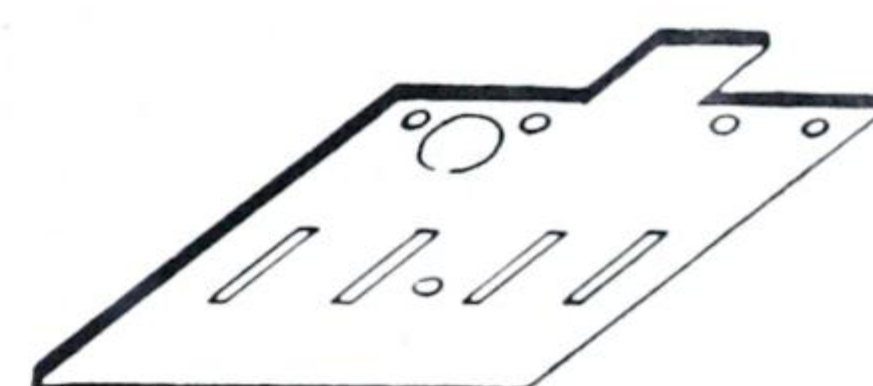
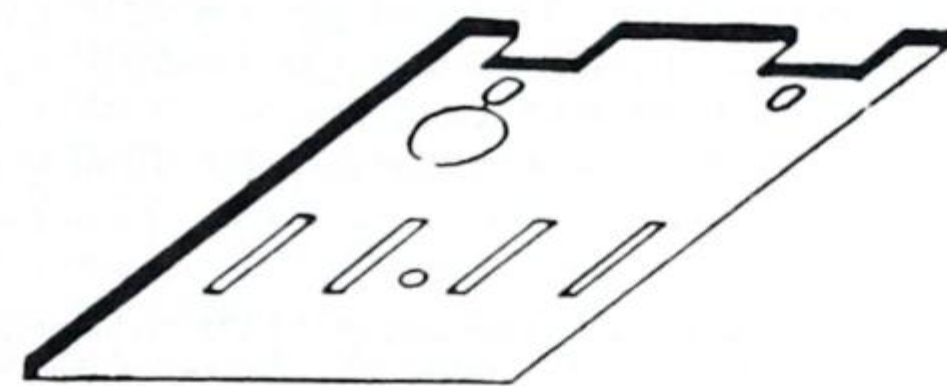
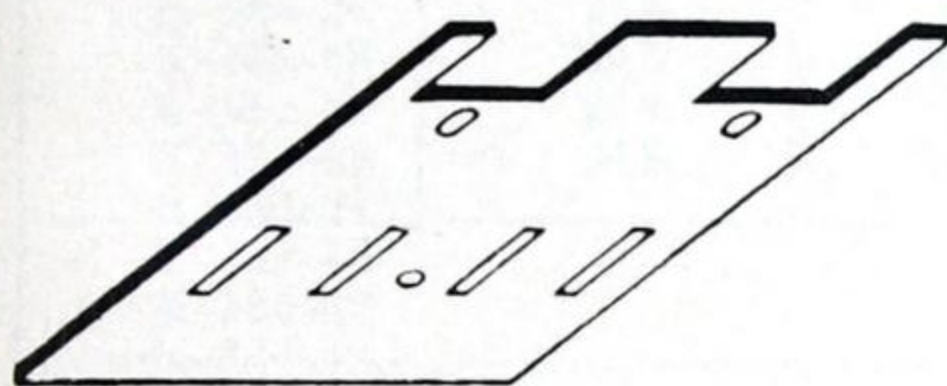

Two Lamp Slimline Lampholder Plates Catalogue No.*	
Decorative	Economy
1183	1083

Two Lamp Medium Bi-Pin Lampholder Plates Catalogue No.*	
Decorative	Economy
1184	1084

Two Lamp Mogul Bi-Pin Lampholder Plates Catalogue No.*	
Decorative	Economy
1185	1085

*Cat. No. refers to pair of plates. Dimensions:—Length 6", Width 4 3/4".

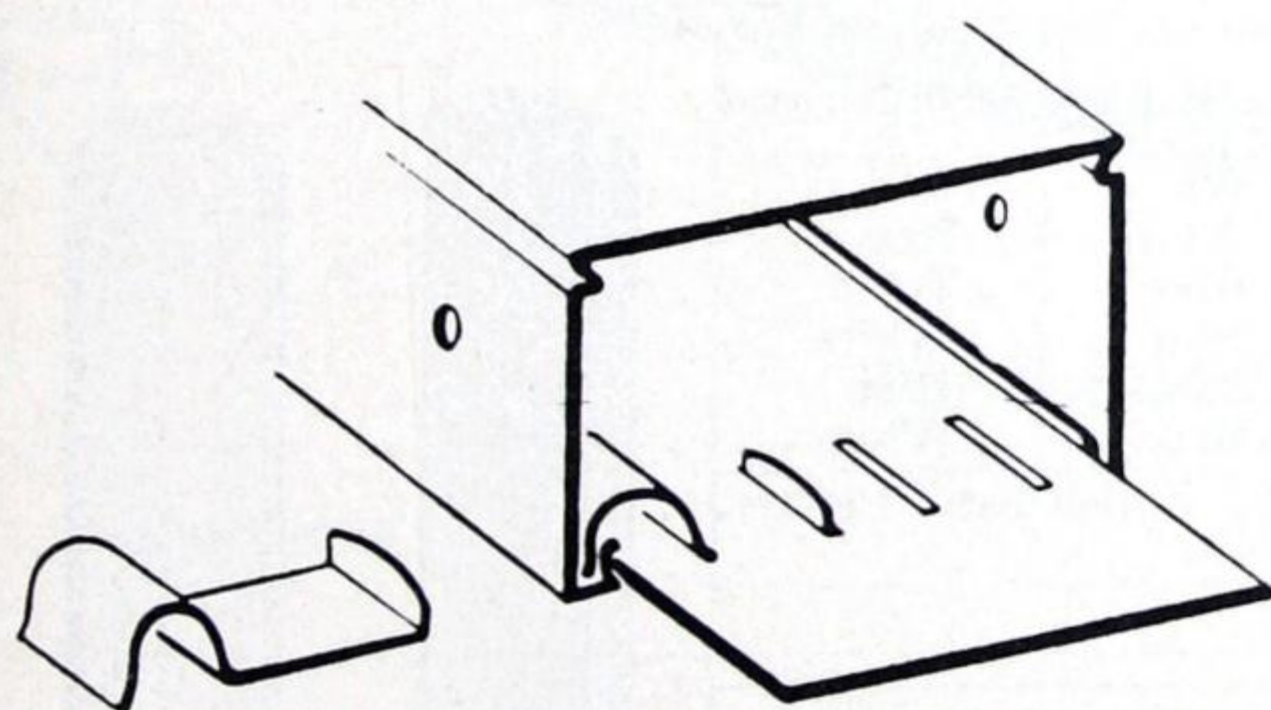

Lampholder mounting plates are quickly and easily positioned in the wire channel without the use of tools by means of specially designed spring clips shown at left. Clips supplied with lampholder plates.



HANGER	
Catalogue Number	Description
1009	Sliding Clamp Type



FLUORESCENT STRIPLIGHTING—DIRECTION SIGNS—BRACKETS

Striplighting Units

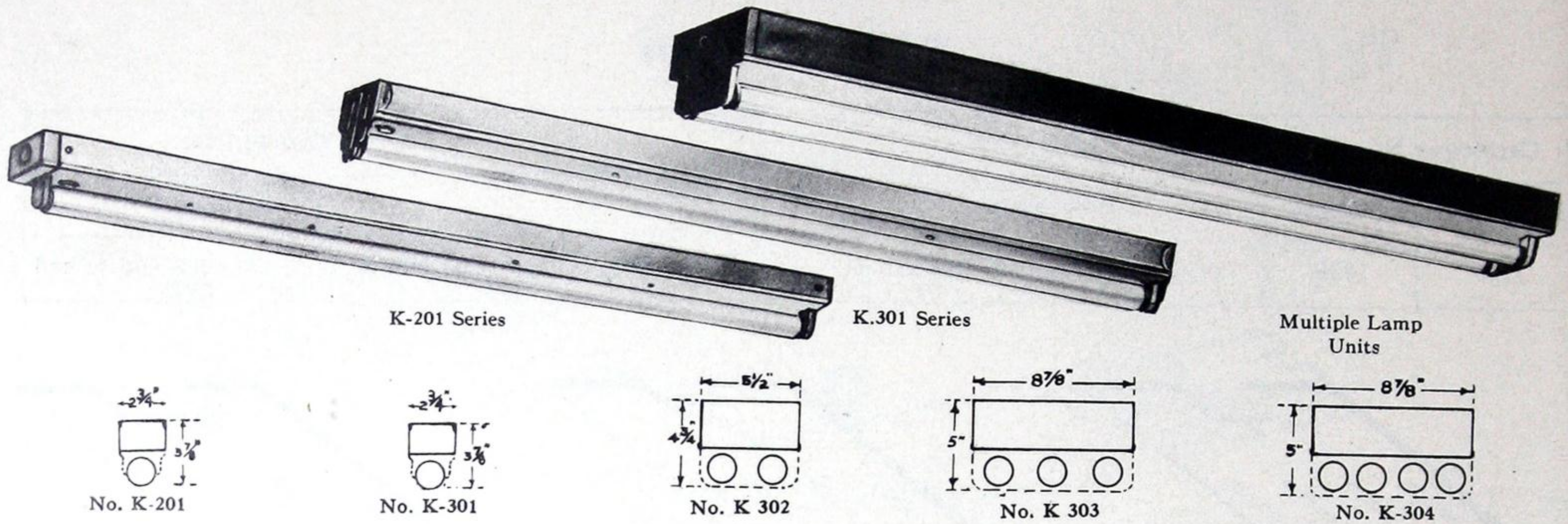

Catalogue No.*	Description	Lamps	Dimensions		
			Length	Width	Depth
K-201-18	Single Lamp Unit for continuous mounting	1 x 15W	19"	2 5/8"	3 5/8"
K-201-24	Single Lamp Unit for continuous mounting	1 x 20W	25"	2 5/8"	3 5/8"
K-201-48	Single Lamp Unit for continuous mounting	1 x 40W	49"	2 5/8"	3 5/8"
K-301-18	Single Lamp Unit for individual mounting	1 x 15W	18 1/4"	2 3/4"	3 7/8"
K-301-24	Single Lamp Unit for individual mounting	1 x 20W	24 1/4"	2 3/4"	3 7/8"
K-301-48	Single Lamp Unit for individual mounting	1 x 40W	48 1/4"	2 3/4"	3 7/8"
K-301-96	Two Lamp In-Line Unit for individual mounting	2 x 40W	96 1/4"	2 3/4"	3 7/8"
K-302-24	Multiple Lamp Unit for individual or continuous mounting	2 x 20W	24 1/8"	5 1/2"	4 3/4"
K-302-48†	Multiple Lamp Unit for individual or continuous mounting	2 x 40W	48 1/8"	5 1/2"	4 3/4"
K-303-24	Multiple Lamp Unit for individual or continuous mounting	3 x 20W	24 1/8"	8 7/8"	5"
K-303-48	Multiple Lamp Unit for individual or continuous mounting	3 x 40W	48 1/8"	8 7/8"	5"
K-304-24	Multiple Lamp Unit for individual or continuous mounting	4 x 20W	24 1/8"	8 7/8"	5"
K-304-48†	Multiple Lamp Unit for individual or continuous mounting	4 x 40W	48 1/8"	8 7/8"	5"

*Finished in baked white enamel.

†Available for instant start operation. Specify standard or series-sequence type ballasts.

Direction Signs and Brackets



KG-638-18



KG-639-18



KG-646-18



KG-637-18



KG-636-18
DIRECTION SIGNS



KG-648-18

Catalogue No.*	Description	Lamps	Lettering	Background
KG-636-18	Exit	1x15W	White	Red
KG-637-18	Sortie	1x15W	White	Red
KG-638-18	Gentlemen	1x15W	Blue	White
KG-639-18	Ladies	1x15W	Blue	White
KG-646-18	Information	1x15W	White	Blue
KG-648-18	Telephones	1x15W	Blue	White

*Dimensions: Length 20", Width 4 1/2", Depth 4 1/2". Finish Satin Pewter. Special lettering if specified.

BRACKETS

Catalogue No.*	Description	Lamps	Description		
			Length	Width	Depth
K-41-18	Bare Lamp	1x15W	20"	4 1/2"	3 1/2"
K-51-18	Adjustable metal reflector	1x15W	20"	4 1/2"	4 1/2"
KG-261-18	Decorative curved glass	1x15W	20"	4 1/2"	4"
KP-271-18	Curved plastic panel	1x15W	20"	4 1/2"	4"

*Specify with baked white enamel or polished chrome finish.

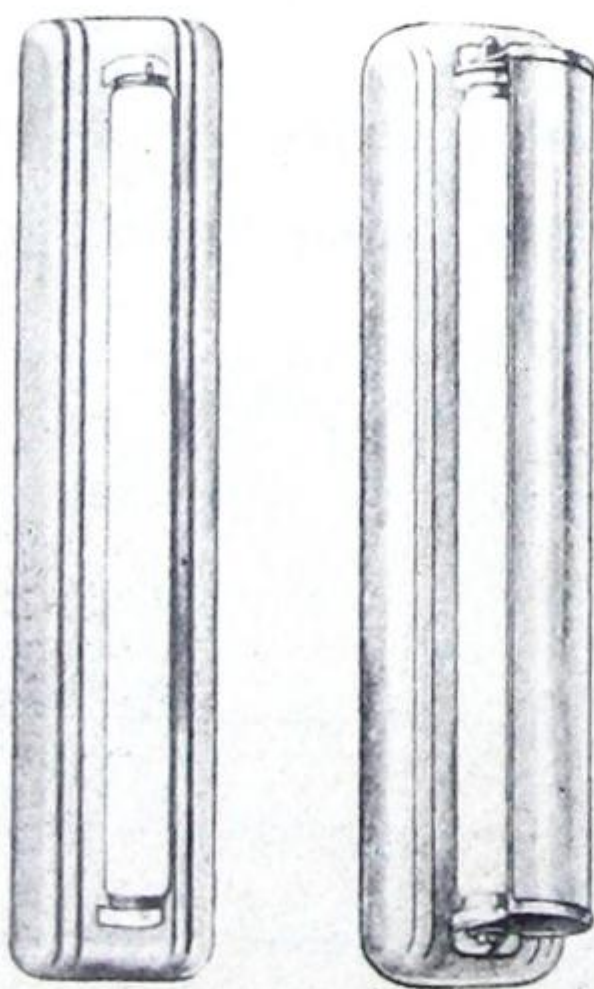

K-41-18

K-51-18

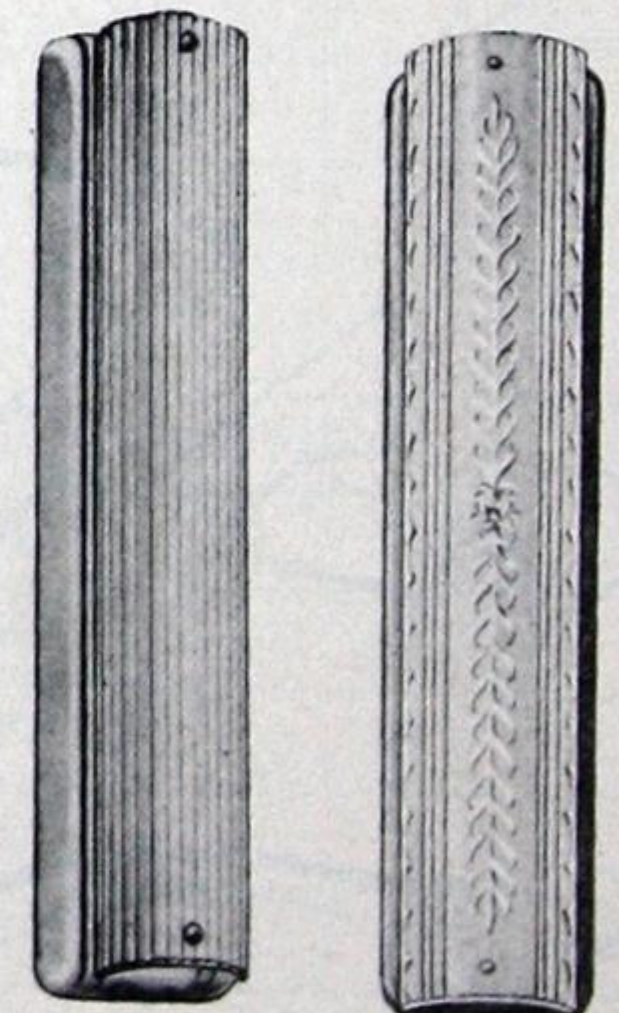

KP-271-18

KG-261-18



SHOW-WINDOW AND COVE LIGHTING UNITS

Show-Window Units

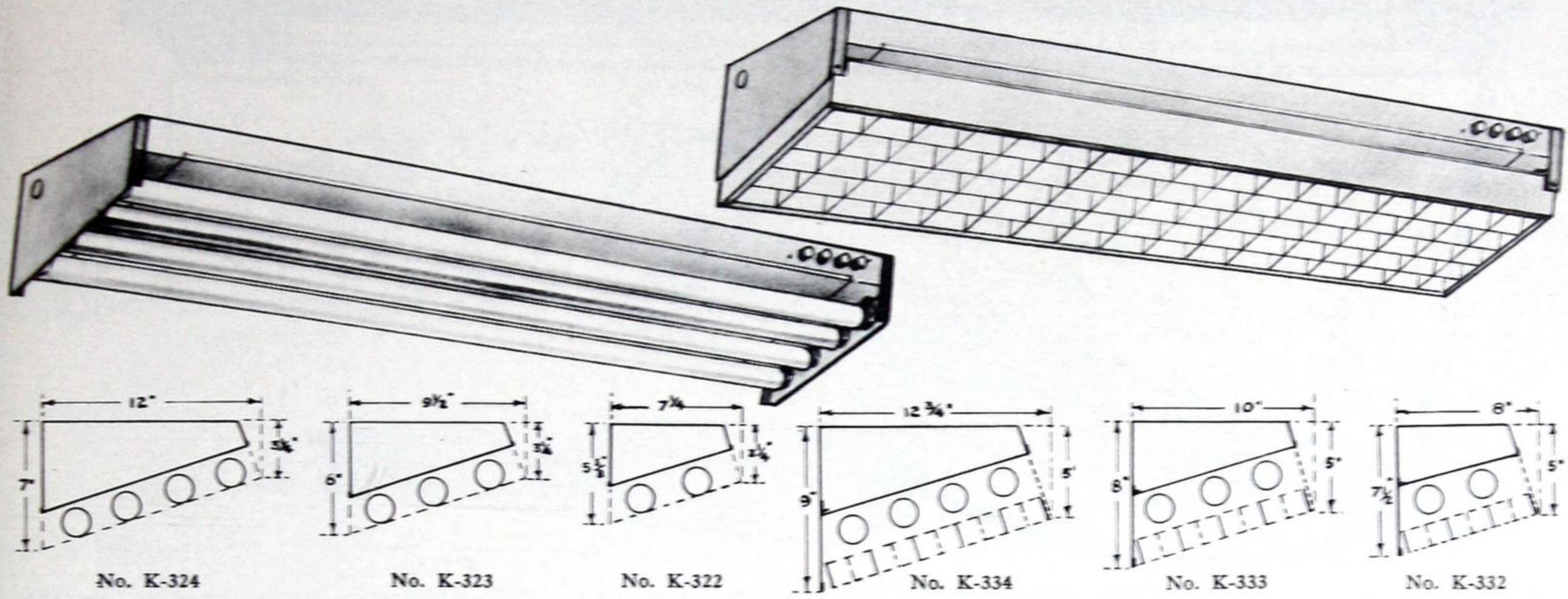

For Individual or Continuous Mounting

Catalogue No.	Description*	Lamps	Dimensions		
			Length	Width	Depth
K-322-24	Bare Lamp Unit	2 x 20W	24 1/4"	7 1/4"	5 5/8"
K-322-48	Bare Lamp Unit	2 x 40W	48 1/4"	7 1/4"	5 5/8"
K-323-24	Bare Lamp Unit	3 x 20W	24 1/4"	9 1/2"	6"
K-323-48	Bare Lamp Unit	3 x 40W	48 1/4"	9 1/2"	6"
K-324-24	Bare Lamp Unit	4 x 20W	24 1/4"	12"	7"
K-324-48	Bare Lamp Unit	4 x 40W	48 1/4"	12"	7"
K-332-24	Hinged Louvered Unit	2 x 20W	24 1/4"	8"	7 1/2"
K-332-48	Hinged Louvered Unit	2 x 40W	48 1/4"	8"	7 1/2"
K-333-24	Hinged Louvered Unit	3 x 20W	24 1/4"	10"	8"
K-333-48	Hinged Louvered Unit	3 x 40W	48 1/4"	10"	8"
K-334-24	Hinged Louvered Unit	4 x 20W	24 1/4"	12 3/4"	9"
K-334-48	Hinged Louvered Unit	4 x 40W	48 1/4"	12 3/4"	9"

*Finish: Baked White Enamel.

"Covelite" Units



For Individual or Continuous Mounting

Catalogue No.	Description*	Lamps	Dimensions		
			Length	Width	Depth
CG-951-24	Curved Albalite glass panel	1 x 20W	24 1/4"	4 3/4"	4 5/8"
CG-951-48	Curved Albalite glass panel	1 x 40W	48 1/4"	4 3/4"	4 5/8"
CG-952-24	Curved side and flat bottom Albalite Panels	2 x 20W	24 1/4"	8 1/2"	4 5/8"
CG-952-48	Curved side and flat bottom Albalite Panels	2 x 40W	48 1/4"	8 1/2"	4 5/8"

*Finish: Baked White Enamel.



SHOWCASE UNITS

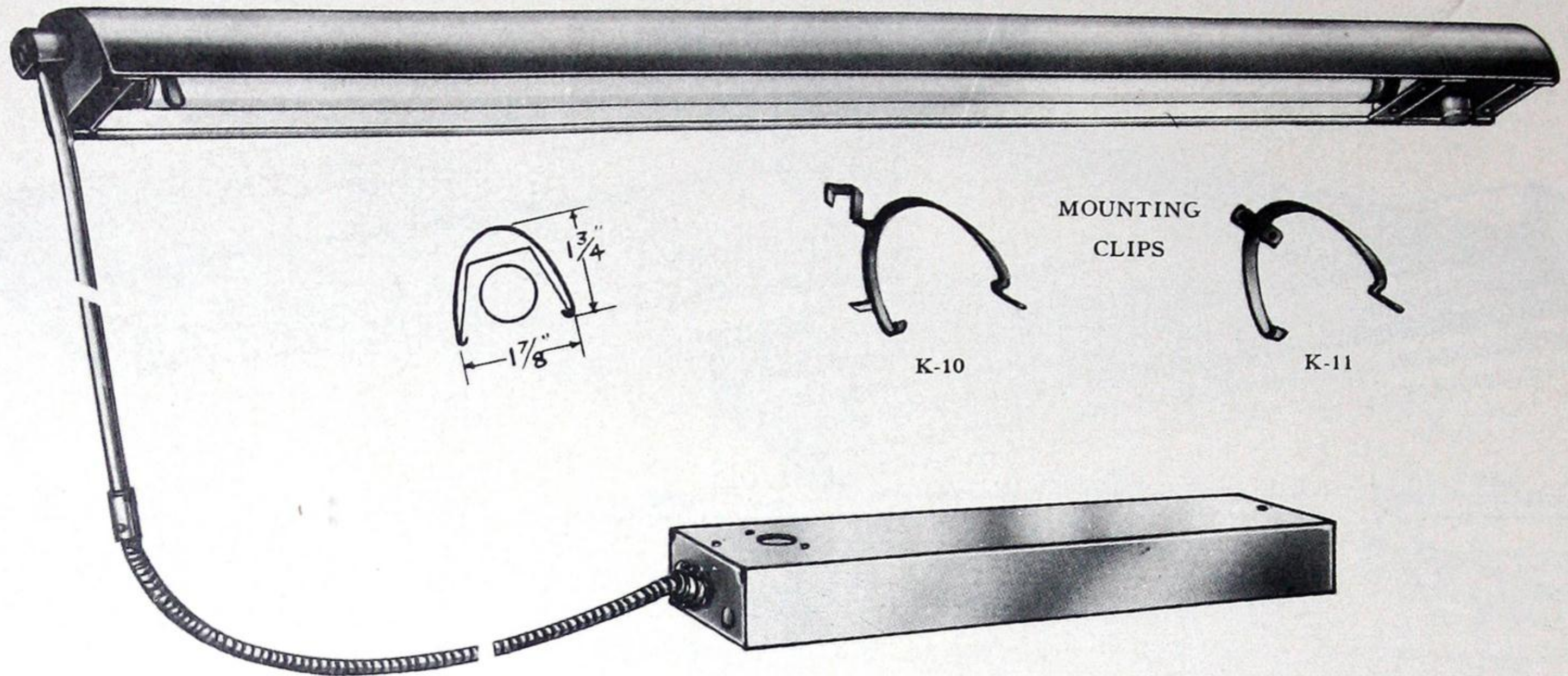

These showcase lighting fixtures have been developed for use with 15 watt 18" and 30 watt 36" T-8 fluorescent lamps. They are available in standard lengths of 41" to 7 feet in one complete unit to fit each size of standard showcase. Fixtures are finished in satin nickel. Inside reflectors finished in hard baked white enamel.

These fixtures produce the maximum amount of light from the smallest practical reflector cross section size. Lamps are concealed from the view of both customer and sales people.

Fixtures are provided with a special Mechanical Ejector, the use of which permits reduction in the size of the reflector. To release the lamp simply push the lever and the lamp will be ejected from the reflector.

The catalogue numbers listed below include the fixture completely wired with all the necessary parts needed for installation in all types of showcases, all in one individual package. This includes standard starters, sockets, ballast and box for 110 volt 60 cycle AC operation: 8 foot leads to reach ballast, 3 feet tubing, 3 feet steel flexible conduit, conduit straps for tubing, connectors and elbow, also mounting clips for either glass or wood frame cases. Please specify type of clips required.

Complete Units

Catalogue No.*	Nominal length of showcase	Minimum fixture length†	Number of lamps	
			15W 18"	30W 36"
K1-36	4 feet	41 3/4"	—	1
K2-36	5 feet	44"	2	—
K2-54	6 feet	62 1/2"	1	1
K2-72	7 feet	80 1/2"	—	2

*Specify type of mounting clips required i.e. for glass or wood cases.

†Special lengths available if specified.

Component Parts

Catalogue No.	Description	Catalogue No.	Description
K3	1/2" Tubing	K8	Box connector for 3/8" flexible conduit
K4	Tubing strap	K9	Elbow for 1/2" tubing
K5	3/8" Flexible Conduit	K10	Mounting clips for wood frame cases
K6	Straps for flexible conduit	K11	Mounting clips for all glass cases
K7	Straight connector for joining 1/2" tubing and 3/8" flexible conduit	K12	Ballast box 17" long
		K13	Ballast box 28" long

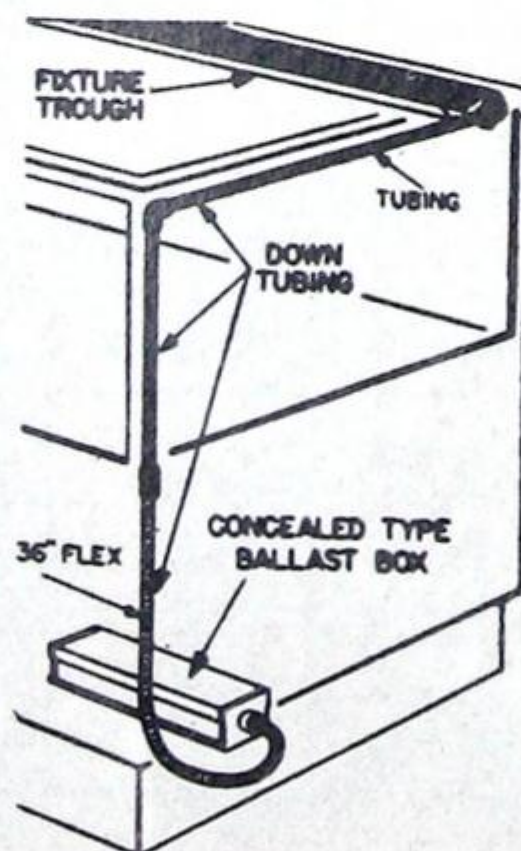

SHOWING WIRE ENTRY AT BACK OF CASE

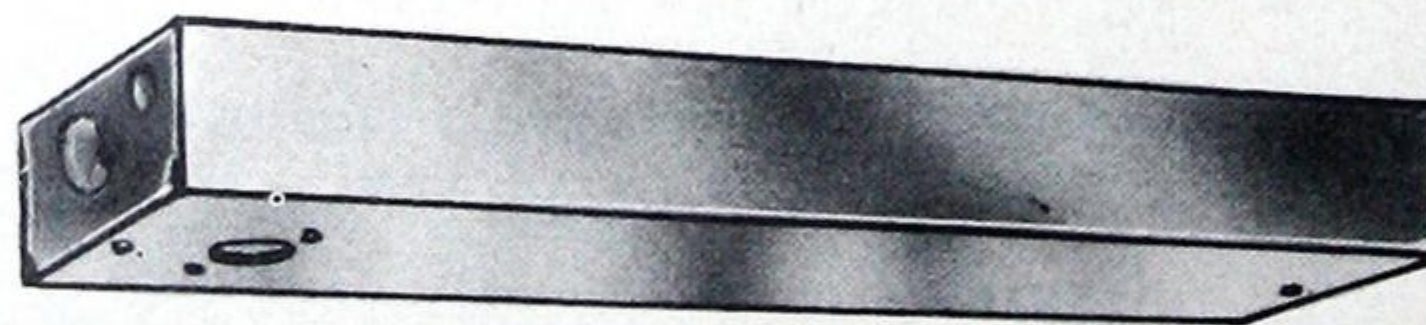

SIZES OF BALLAST BOXES

Width 3" Height 2" Lengths as below.
No. K1-36—For 1-30 w..... 17" long.
No. K2-36—For 2-15 w..... 17" long.
No. K2-54—For 1-15 w & 1-30 w..... 28" long.
No. K2-72—For 2-30 w..... 17" long.

Knock-outs are provided for electrical connections and for toggle switch. (switch not supplied.)

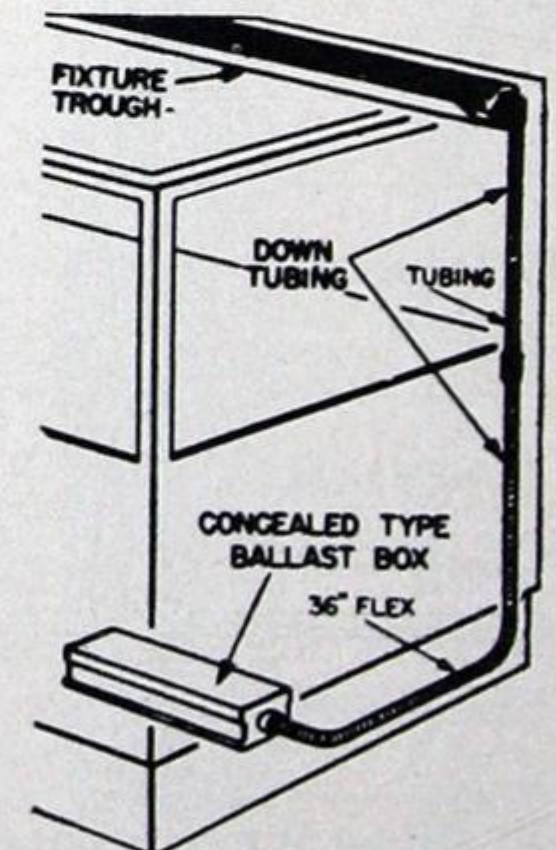

SHOWING WIRE ENTRY AT FRONT OF CASE



FLUORESCENT AND SLIMLINE RECESSED TROFFERS

Day-Brite Recessed Troffers

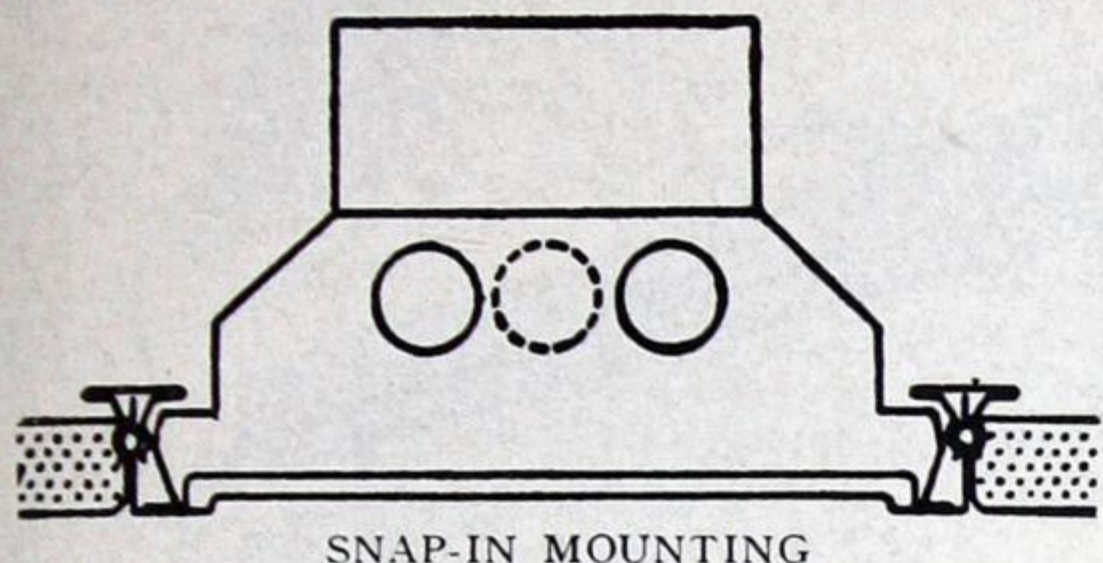

SNAP-IN MOUNTING

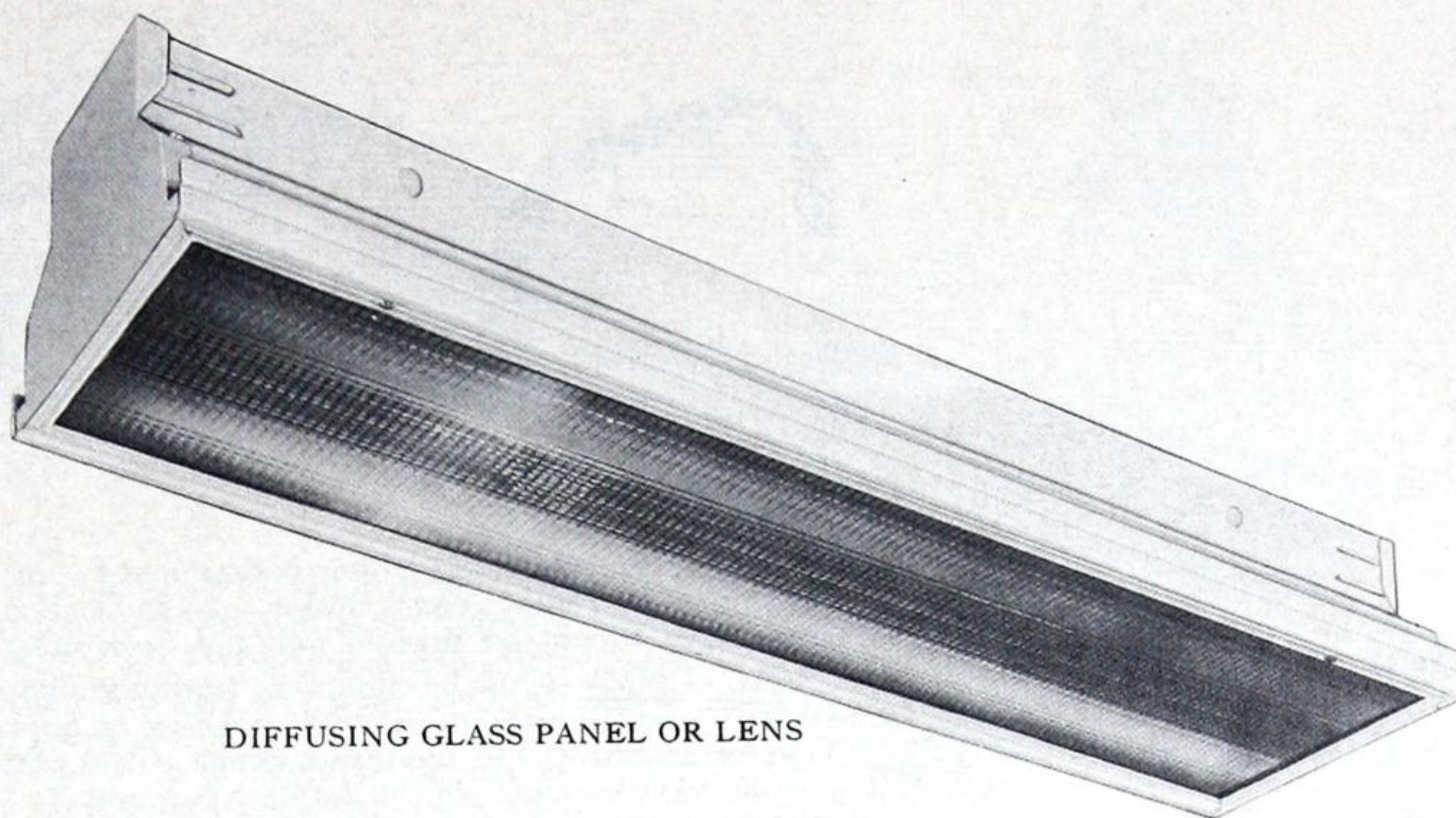

DIFFUSING GLASS PANEL OR LENS

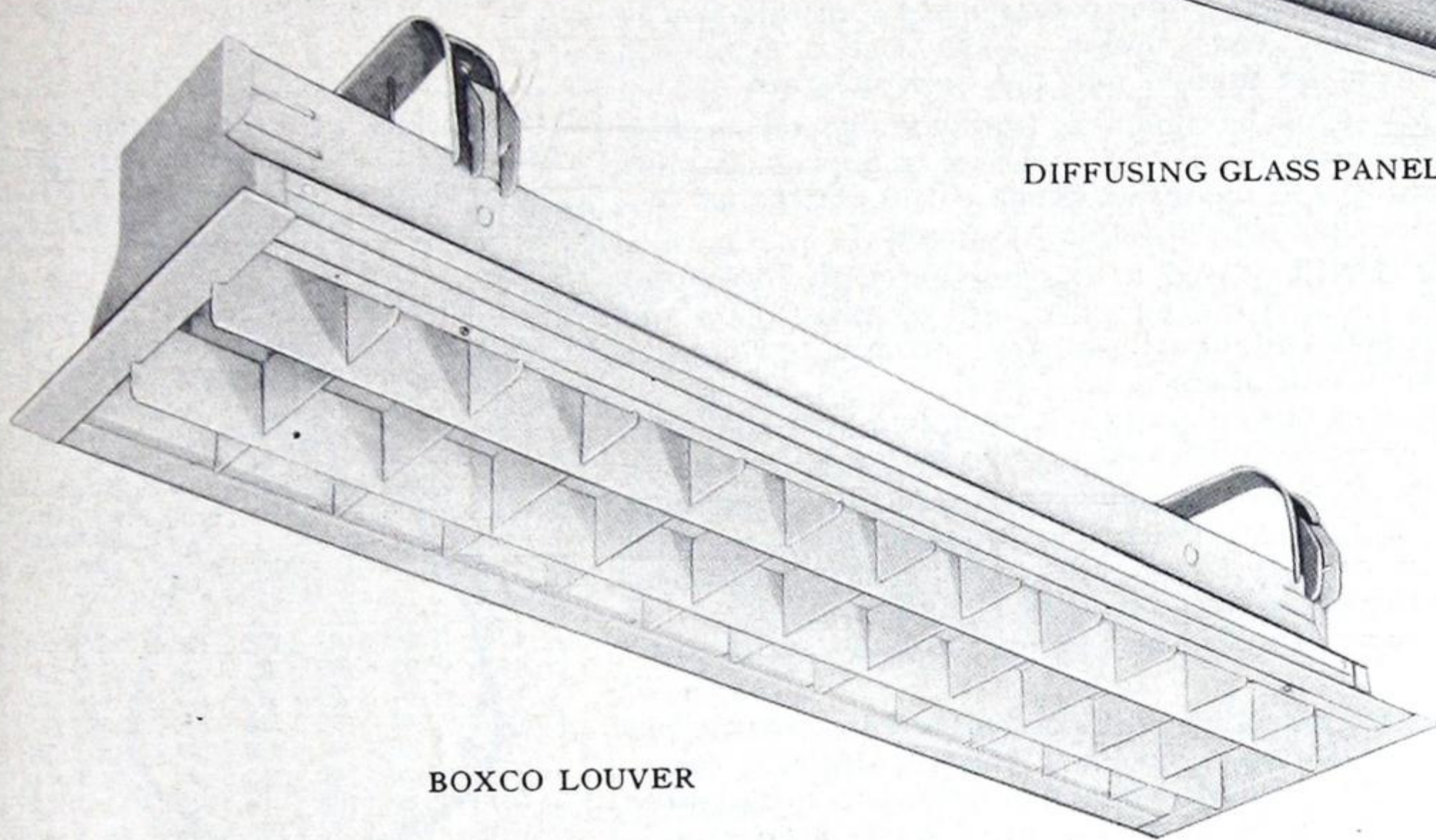

BOXCO LOUVER

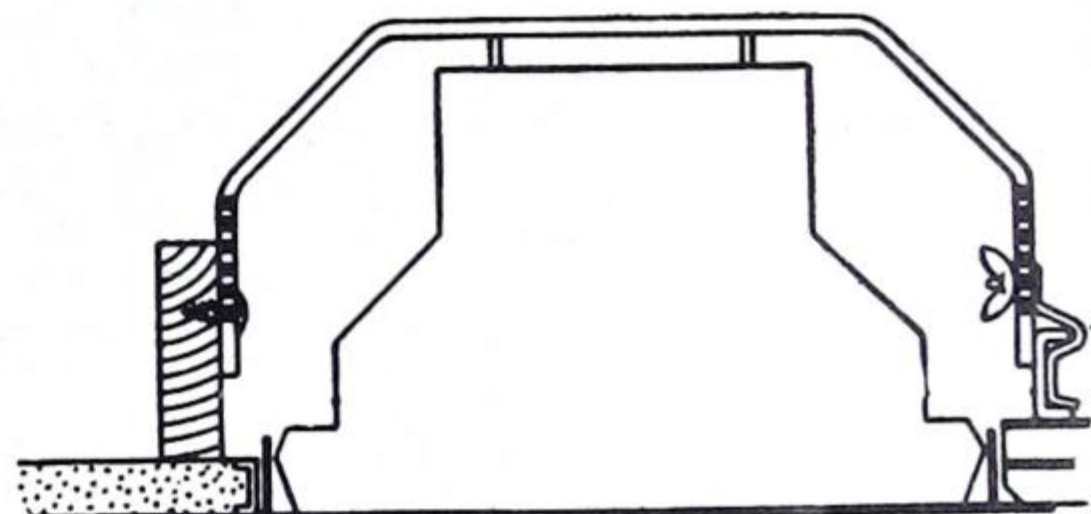

FLANGE MOUNTING

For single unit or continuous row installation, the Day-Brite Recessed Troffer is available for use with two or three fluorescent or slimline lamps. Recessed Troffer fixtures are made with provision for two different mounting methods, flange type for mounting with or without suspension straps and snap-in type for use with Tee Bar Ceiling Construction. The units are supplied as basic or individual units and extension units for making up continuous rows.

All fixture interiors and exposed trim are finished in baked Super-White enamel providing a diffuse reflecting surface of high efficiency.

BASIC UNIT: Substantially constructed of heavy guage steel throughout, the entire body is assembled of die-formed parts and is provided with 1/2" knockouts for service connections.

END PLATES: Die-formed steel for flange type or snap-in type of troffer.

SUSPENSION STRAPS: Suspension Straps are normally supplied with flange type troffers. However, with some types of ceiling construction it is possible to mount the troffers without suspension straps, resulting in lower overall cost of the lighting equipment.

COUPLING PLATES: Die-formed coupling plates ensure rigidity and correct alignment where units are mounted in continuous rows.

LOUVERS: The entire louver assembly can be hinged from either side or completely removed for maintenance. No tools are needed. It is pleasing in appearance and provides correct shielding of the light source. The double wall construction ensures maximum strength and rigidity.

DIFFUSING GLASS OR LENS PANELS: Troffers equipped with Albalite diffusing glass or Corning one-piece lightweight lens panels are available. These panels are rigidly supported in die rolled frames, having separable hinges allowing the complete frame to be hinged from either side or completely removed.

WIRING: All units are supplied wired complete with ballasts and sockets. To ensure maximum efficiency and lamp life, best quality fluorescent and slimline ballasts are supplied. Fluorescent units are equipped with fully compensated ballasts and starters, slimline units with series-sequence ballasts.



FLUORESCENT AND SLIMLINE RECESSED TROFFERS

Day-Brite Flange Type Recessed Troffers with Hinged Boxco Louvers

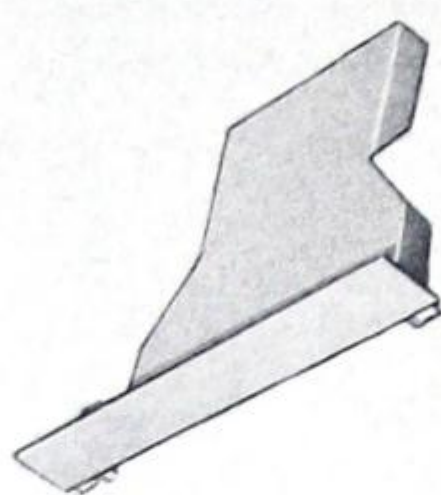

END PLATE



COUPLING PLATE

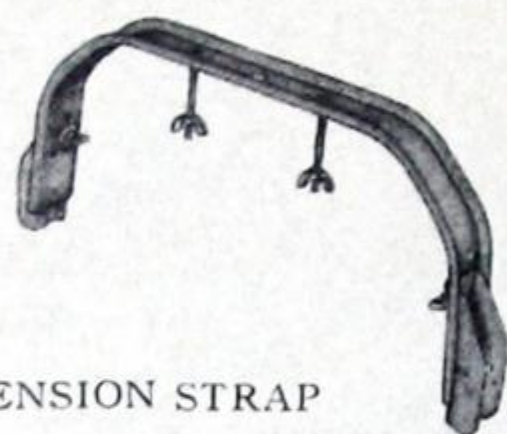

SUSPENSION STRAP

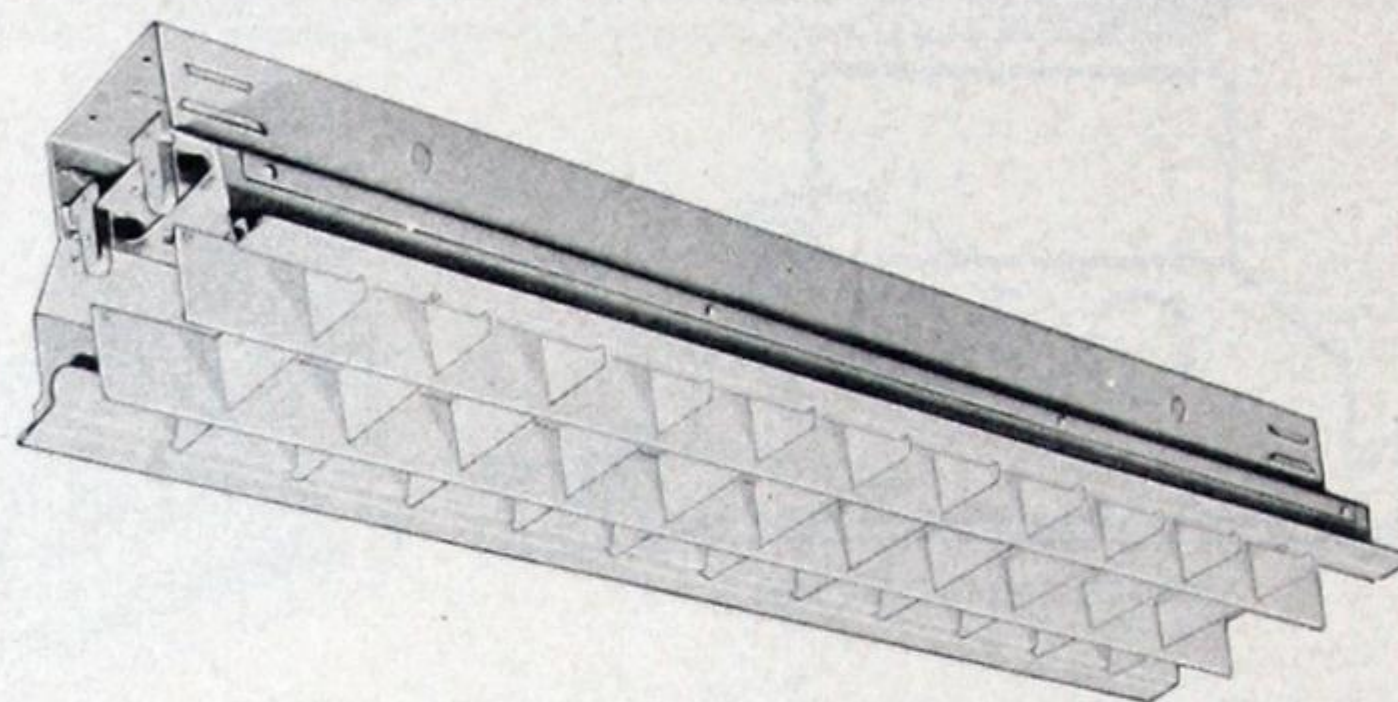

SHIELDING LENGTHWISE 20°		ANGLE CROSSWISE 35°				
SPACING 1xMH		EFF 53.0%				
M.F.	BOXCO LOUVER FLUORESCENT 2x40W LAMP	0% ↑				
G.75		53.0% ↓				
M.70						
P.65						
CEILING	75%	50%				
WALLS	50%	30%	10%	50%	30%	10%
ROOM INDEX	COEFFICIENT OF UTILISATION					
J	.28	.26	.24	.27	.25	.23
I	.34	.32	.30	.33	.31	.29
H	.37	.35	.34	.36	.34	.33
G	.40	.38	.37	.39	.37	.36
F	.42	.40	.38	.40	.38	.37
E	.44	.43	.41	.43	.42	.40
D	.47	.45	.43	.45	.44	.42
C	.49	.46	.45	.47	.45	.44
B	.50	.47	.47	.48	.46	.45
A	.51	.49	.48	.49	.47	.46

The flange type recessed troffer is designed for installation in any type of ceiling construction except T-Bar acoustical ceilings for which the snap-in unit has been designed.

BASIC UNIT—Can be mounted individually or as first fixture in continuous row. Unit consists of wiring channel, reflector assembly and mounting frame. End plates and suspension hangers supplied with each basic unit.

EXTENSION UNIT—Used in conjunction with basic unit for continuous rows. Units supplied with coupling plate and suspension hangers; end plate from basic unit used to complete the last extension unit of continuous row.

Both basic and extension units are complete with ballasts, starters for fluorescent units, and include wiring.

SUSPENSION STRAP—Supplied with basic and extension units, designed for attachment to wood ground or steel channels. With some types of ceiling construction suspension strap may be dispensed with resulting in lower overall cost of lighting equipment. Suspension straps normally supplied as listed below.

LOUVER—Boxco louver assembly of double wall construction designed to provide correct shielding, rigidity and easy maintenance. To simplify installation and maintenance a separable hinge arrangement permits attachment of louver after installation of troffer unit and allows for hinging from either side of the unit.

END PLATE—Flange type end plate is of die-formed steel construction. Knockout for through wiring and special steel baffle strip to prevent light leaks provided. Exposed flange finished in Super-White enamel. Two end plates supplied with each basic unit.

COUPLING PLATE—Die formed to ensure rigidity and correct alignment where mounted in continuous rows. Steel baffle strip provided to prevent light leaks. One coupling plate supplied with each extension unit.

SHIELDING LENGTHWISE 20°		ANGLE CROSSWISE 35°				
SPACING 1.2xMH		EFF 57.0%				
M.F.	BOXCO LOUVER SLIMLINE 2x96" T12 LAMPS	0% ↑				
G.75		57.0% ↓				
M.70						
P.65						
CEILING	75%	50%				
WALLS	50%	30%	10%	50%	30%	10%
ROOM INDEX	COEFFICIENT OF UTILISATION					
J	.29	.27	.25	.28	.26	.24
I	.35	.33	.31	.34	.32	.30
H	.37	.36	.35	.37	.35	.34
G	.41	.39	.38	.40	.38	.37
F	.43	.41	.39	.41	.39	.38
E	.45	.44	.42	.44	.43	.41
D	.49	.46	.44	.46	.45	.43
C	.51	.47	.46	.49	.46	.45
B	.52	.48	.46	.50	.47	.46
A	.53	.50	.49	.51	.48	.47

Fluorescent

Catalogue No.*	Lamp Watts (T-12)	Cycles	Length	Component Parts				
				Troffer Body No.*	Boxco Louver No. 42224	End Plate No. 7686	Coupling Plate Ng. 7687	Suspension Strap** No. 7709
Complete Unit								
42245-DF-B	2 x 40	25/60	48"	1, 42205-DF	1	2	0	2
42245-DF-E	2 x 40	25/60	48"	1, 42205-DF	1	0	1	1
42245-60-B	2 x 40	60	48"	1, 42205-60	1	2	0	2
42245-60-E	2 x 40	60	48"	1, 42205-60	1	0	1	1
42245-60-IS-B	2 x 40	60	48"	1, 42205-60-IS	1	2	0	2
42245-60-IS-E	2 x 40	60	48"	1, 42205-60-IS	1	0	1	1
42345-60-B	3 x 40	60	48"	1, 42305-60	1	2	0	2
42345-60-E	3 x 40	60	48"	1, 42305-60	1	0	1	1
42245-SL-96-B	2 x 72	60	96"	1, 42205-SL-96	2	2	0	2
42245-SL-96-E	2 x 72	60	96"	1, 42205-SL-96	2	0	1	1
42245-SL-48-B	2 x 36	60	48"	1, 42205-SL-48	1	2	0	2
42245-SL-48-E	2 x 36	60	48"	1, 42205-SL-48	1	0	1	1

*Suffixes—"B" basic unit, "E" extension unit, "60IS" for instant start operation.

**Suspension straps may not be required for some types of ceiling construction. Overall cost of lighting equipment is reduced in such cases. Specify unit catalogue number "Less Suspension Straps".



FLUORESCENT AND SLIMLINE RECESSED TROFFERS

Day-Brite Flange Type Recessed Troffers with Hinged Alba-Lite Diffusing Glass Panel

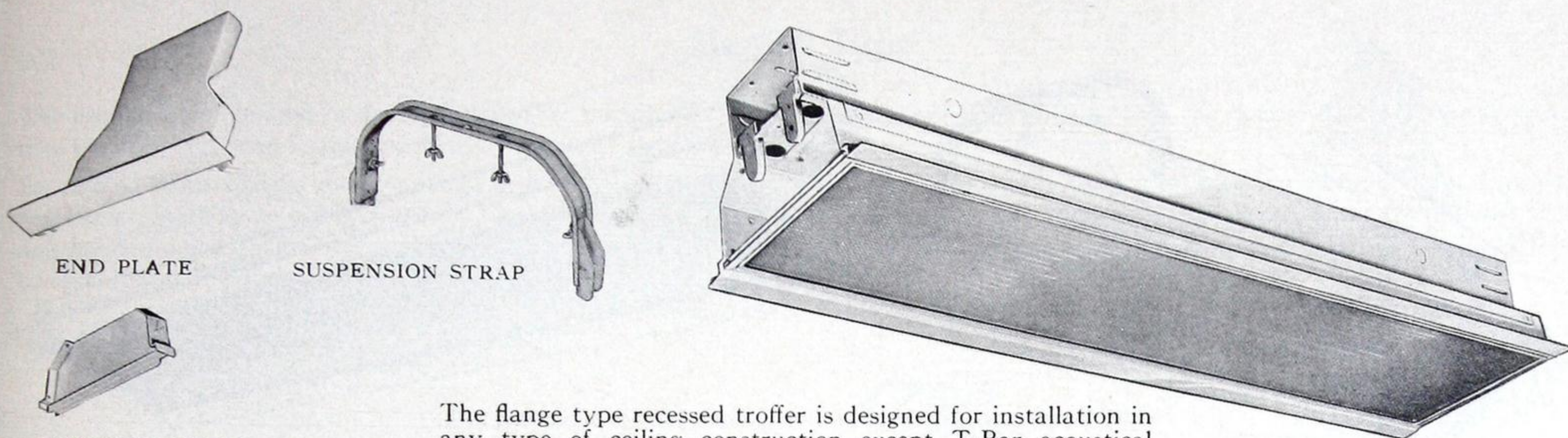

The flange type recessed troffer is designed for installation in any type of ceiling construction except T-Bar acoustical ceilings for which the snap-in unit has been designed.

BASIC UNIT—Can be mounted individually or as first fixture in continuous row. Unit consists of wiring channel, reflector assembly and mounting frame. End plates and suspension hangers supplied with each basic unit.

EXTENSION UNIT—Used in conjunction with basic unit for continuous rows. Units supplied with coupling plate and suspension hangers; end plate from basic unit used to complete the last extension unit of continuous row.

Both basic and extension units are complete with ballasts, starters for fluorescent units, and include wiring.

SUSPENSION STRAP—Supplied with basic and extension units, designed for attachment to wood ground or steel channels. With some types of ceiling construction suspension strap may be dispensed with resulting in lower overall cost of lighting equipment. Suspension straps normally supplied as listed below.

GLASS PANEL—The Albalite diffusing glass panel is supported in a die rolled frame. To simplify installation and maintenance a separable hinge arrangement permits attachment of frame after installation of troffer unit and allows for hinging from either side of the unit.

SPACING 1.0xMH		EFF 56.0%	
M.F.	DIFFUSING PANEL	0% ↑	
G.75	FLUORESCENT	56.0% ↓	
M.70	2x40W		
P.65			
CEILING	75%	50%	
WALLS	50% 30% 10%	50%	30% 10%
ROOM INDEX	COEFFICIENT OF UTILISATION		
J	.28	.25	.22
I	.35	.32	.30
H	.38	.36	.34
G	.41	.38	.37
F	.43	.41	.38
E	.46	.44	.42
D	.49	.47	.45
C	.51	.49	.47
B	.52	.50	.49
A	.54	.52	.50

SPACING 1.2xMH		EFF 58.3%	
M.F.	DIFFUSING PANEL	0% ↑	
G.75	SLIMLINE	58.3% ↓	
M.70	2x96" T12		
P.65			
CEILING	75%	50%	
WALLS	50% 30% 10%	50%	30% 10%
ROOM INDEX	COEFFICIENT OF UTILISATION		
J	.29	.26	.23
I	.36	.33	.31
H	.39	.37	.35
G	.42	.39	.38
F	.44	.42	.39
E	.47	.45	.43
D	.50	.48	.46
C	.52	.50	.47
B	.53	.51	.50
A	.55	.53	.51

END PLATE—Flange type end plate is of die-formed steel construction. Knockout for through wiring and special steel baffle strip to prevent light leaks provided. Exposed flange finished in Super-White enamel. Two end plates supplied with each basic unit.

COUPLING PLATE—Die formed to ensure rigidity and correct alignment where mounted in continuous rows. Steel baffle strip provided to prevent light leaks. One coupling plate supplied with each extension unit.

Fluorescent

Catalogue No.*	Lamp Watts (T-12)	Cycles	Length	Component Parts				
				Troffer	Diffusing Glass Panel	End Plate	Coupling Plate	Suspension Strap**
Complete Unit				Body No.*	No. 42223	No. 7686	No. 7687	No. 7709
42235-DF-B	2 x 40	25/60	48"	1, 42205-DF	1	2	0	2
42235-DF-E	2 x 40	25/60	48"	1, 42205-DF	1	0	1	1
42235-60-B	2 x 40	60	48"	1, 42205-60	1	2	0	2
42235-60-E	2 x 40	60	48"	1, 42205-60	1	0	1	1
42235-60-IS-B	2 x 40	60	48"	1, 42205-60-IS	1	2	0	2
42235-60-IS-E	2 x 40	60	48"	1, 42205-60-IS	1	0	1	1
42335-60-B	3 x 40	60	48"	1, 42305-60	1	2	0	2
42335-60-E	3 x 40	60	48"	1, 42305-60	1	0	1	1

Slimline

42235-SL-96-B	2 x 72	60	96"	1, 42205-SL-96	2	2	0	2
42235-SL-96-E	2 x 72	60	96"	1, 42205-SL-96	2	0	1	1
42235-SL-48-B	2 x 36	60	48"	1, 42205-SL-48	1	2	0	2
42235-SL-48-E	2 x 36	60	48"	1, 42205-SL-48	1	0	1	1

*Suffixes—"B" basic unit, "E" extension unit, "60IS" for instant start operation.

**Suspension straps may not be required for some types of ceiling construction. Overall cost of lighting equipment is reduced in such cases. Specify unit catalogue number "Less Suspension Straps".



FLUORESCENT AND SLIMLINE RECESSED TROFFERS

Day-Brite Flange Type Recessed Troffers with Hinged Lightweight Prismatic Lens Panels

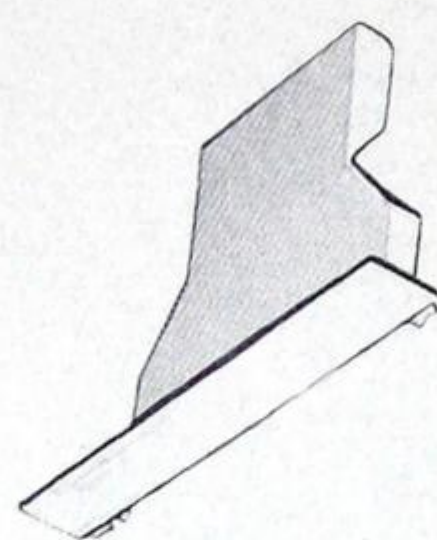

END PLATE

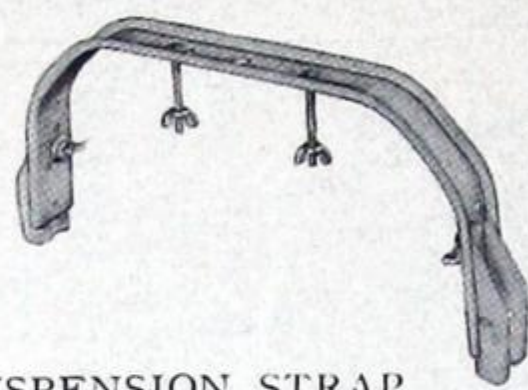

SUSPENSION STRAP

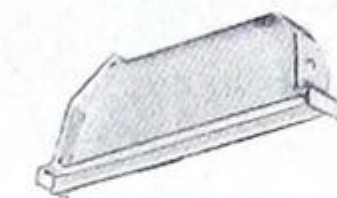
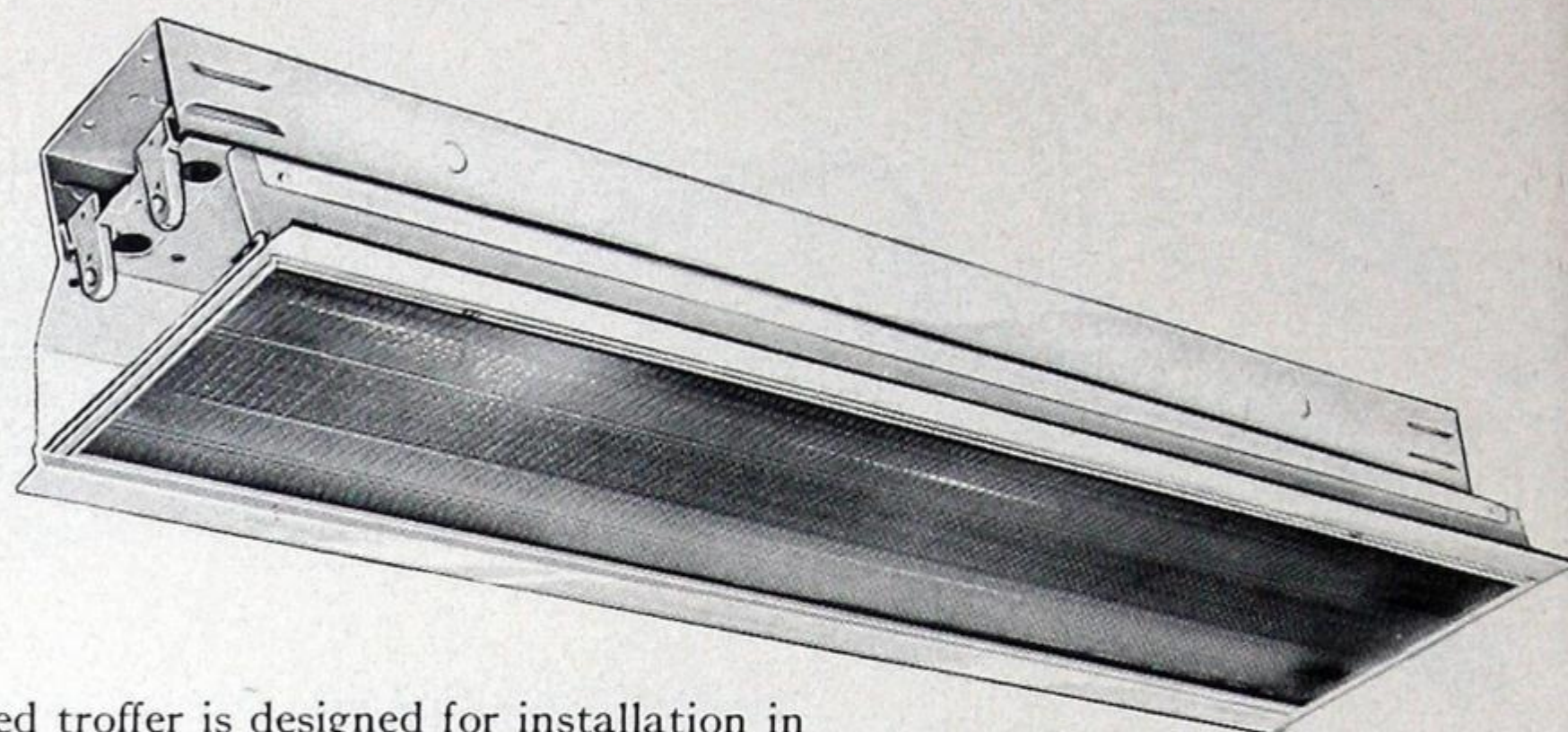

COUPLING PLATE

SPACING 1.0xMH		EFF 61.7%	
M.F.	LENS PANEL FLUORESCENT 2x40W	0% ↑	
G.75		61.7% ↓	
M.70			
P.65			
CEILING	75%	50%	
WALLS	50%	30%	10%
ROOM INDEX	COEFFICIENT OF UTILISATION		
J	.33	.30	.27
I	.39	.36	.36
H	.42	.40	.39
G	.45	.43	.42
F	.48	.46	.43
E	.50	.49	.47
D	.54	.51	.49
C	.55	.52	.51
B	.56	.54	.53
A	.57	.55	.54

The flange type recessed troffer is designed for installation in any type of ceiling construction except T-Bar acoustical ceilings for which the snap-in unit has been designed.

BASIC UNIT—Can be mounted individually or as first fixture in continuous row. Unit consists of wiring channel, reflector assembly and mounting frame. End plates and suspension hangers supplied with each basic unit.

EXTENSION UNIT—Used in conjunction with basic unit for continuous rows. Units supplied with coupling plate and suspension hangers; end plate from basic unit used to complete the last extension unit of continuous row.

Both basic and extension units are complete with ballasts, starters for fluorescent units, and include wiring.

SUSPENSION STRAP—Supplied with basic and extension units, designed for attachment to wood ground or steel channels. With some types of ceiling construction suspension strap may be dispensed with resulting in lower overall cost of lighting equipment. Suspension straps normally supplied as listed below.

LENS PANEL—The light-weight prismatic lens panel is supported in a die rolled frame. To simplify installation and maintenance a separable hinge arrangement permits attachment of frame after installation of troffer unit and allows for hinging from either side of the unit.

SPACING 1.2xMH		EFF 63.5%	
M.F.	LENS PANEL SLIMLINE 2x96" T12	0% ↑	
G.75		63.5% ↓	
M.70			
P.65			
CEILING	75%	50%	
WALLS	50%	30%	10%
ROOM INDEX	COEFFICIENT OF UTILISATION		
J	.35	.32	.31
I	.42	.40	.39
H	.45	.44	.44
G	.49	.47	.47
F	.51	.50	.48
E	.54	.53	.51
D	.57	.55	.53
C	.58	.57	.55
B	.59	.57	.56
A	.60	.58	.57

END PLATE—Flange type end plate is of die-formed steel construction. Knockout for through wiring and special steel baffle strip to prevent light leaks provided. Exposed flange finished in Super-White enamel. Two end plates supplied with each basic unit.

COUPLING PLATE—Die formed to ensure rigidity and correct alignment where mounted in continuous rows. Steel baffle strip provided to prevent light leaks. One coupling plate supplied with each extension unit.

Fluorescent

Catalogue No.*	Lamp Watts (T-12)	Cycles	Length	Component Parts				
				Troffer Body No.*	Prismatic Lens Panel No. 42225	End Plate No. 7686	Coupling Plate No. 7687	Suspension Strap** No. 7709
Complete Unit								
42255-DF-B	2 x 40	25/60	48"	1, 42205-DF	1	2	0	2
42255-DF-E	2 x 40	25/60	48"	1, 42205-DF	1	0	1	1
42255-60-B	2 x 40	60	48"	1, 42205-60	1	2	0	2
42255-60-E	2 x 40	60	48"	1, 42205-60	1	0	1	1
42255-60-IS-B	2 x 40	60	48"	1, 42205-60-IS	1	2	0	2
42255-60-IS-E	2 x 40	60	48"	1, 42205-60-IS	1	0	1	1
42355-60-B	3 x 40	60	48"	1, 42305-60	1	2	0	2
42355-60-E	3 x 40	60	48"	1, 42305-60	1	0	1	1

Slimline

42255-SL-96-B	2 x 72	60	96"	1, 42205-SL-96	2	2	0	2
42255-SL-96-E	2 x 72	60	96"	1, 42205-SL-96	2	0	1	1
42255-SL-48-B	2 x 36	60	48"	1, 42205-SL-48	1	2	0	2
42255-SL-48-E	2 x 36	60	48"	1, 42205-SL-48	1	0	1	1

*Suffixes—"B" basic unit, "E" extension unit, "60IS" for instant start operation.

**Suspension straps may not be required for some types of ceiling construction. Overall cost of lighting equipment is reduced in such cases. Specify unit catalogue number "Less Suspension Straps".



FLUORESCENT AND SLIMLINE RECESSED TROFFERS

Day-Brite Flange and Snap-In Type Recessed Troffers - Installation Data

Flange Type

The Flange type recessed troffer is designed for installation in all types of suspended ceilings, with the exception of Tee-Bar acoustical tiled ceilings; the Snap-In type troffer is specifically designed for Tee-Bar ceiling construction.

Suspension straps are normally supplied with all flange type basic or extension units and can be used with wood ground or steel channel supporter. With some types of ceiling construction, the suspension straps may be dispensed with thus reducing the overall cost of the lighting equipment. Two suspension straps are supplied with each basic 48" fixture, one with each extension unit, three with each 96" basic unit and one with each extension unit.

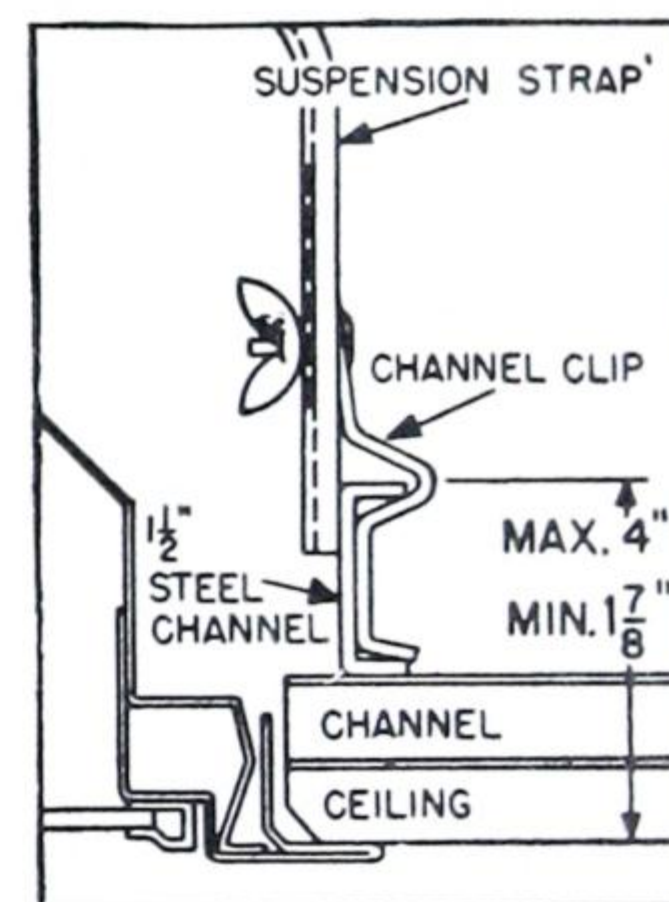
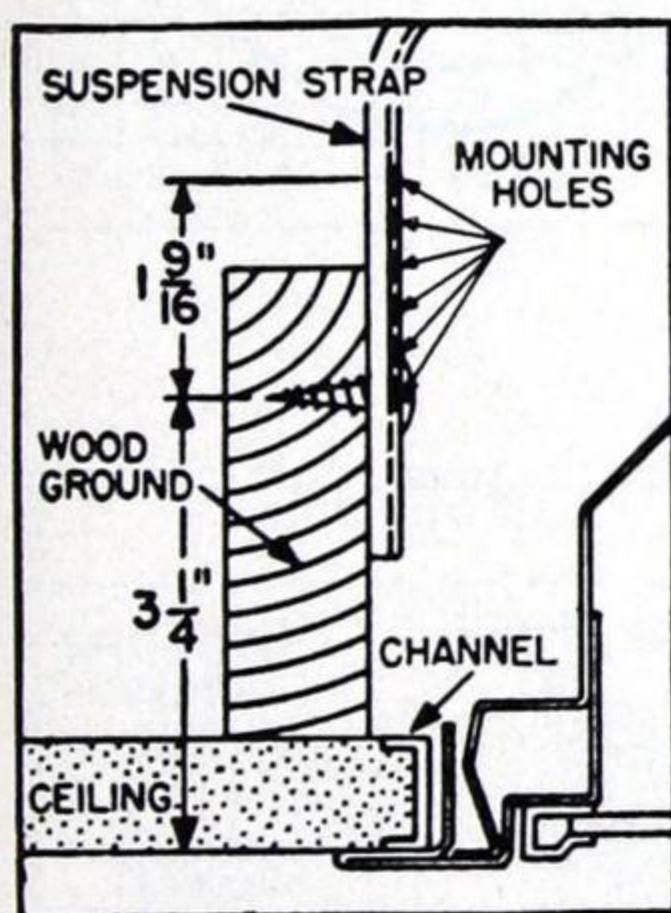
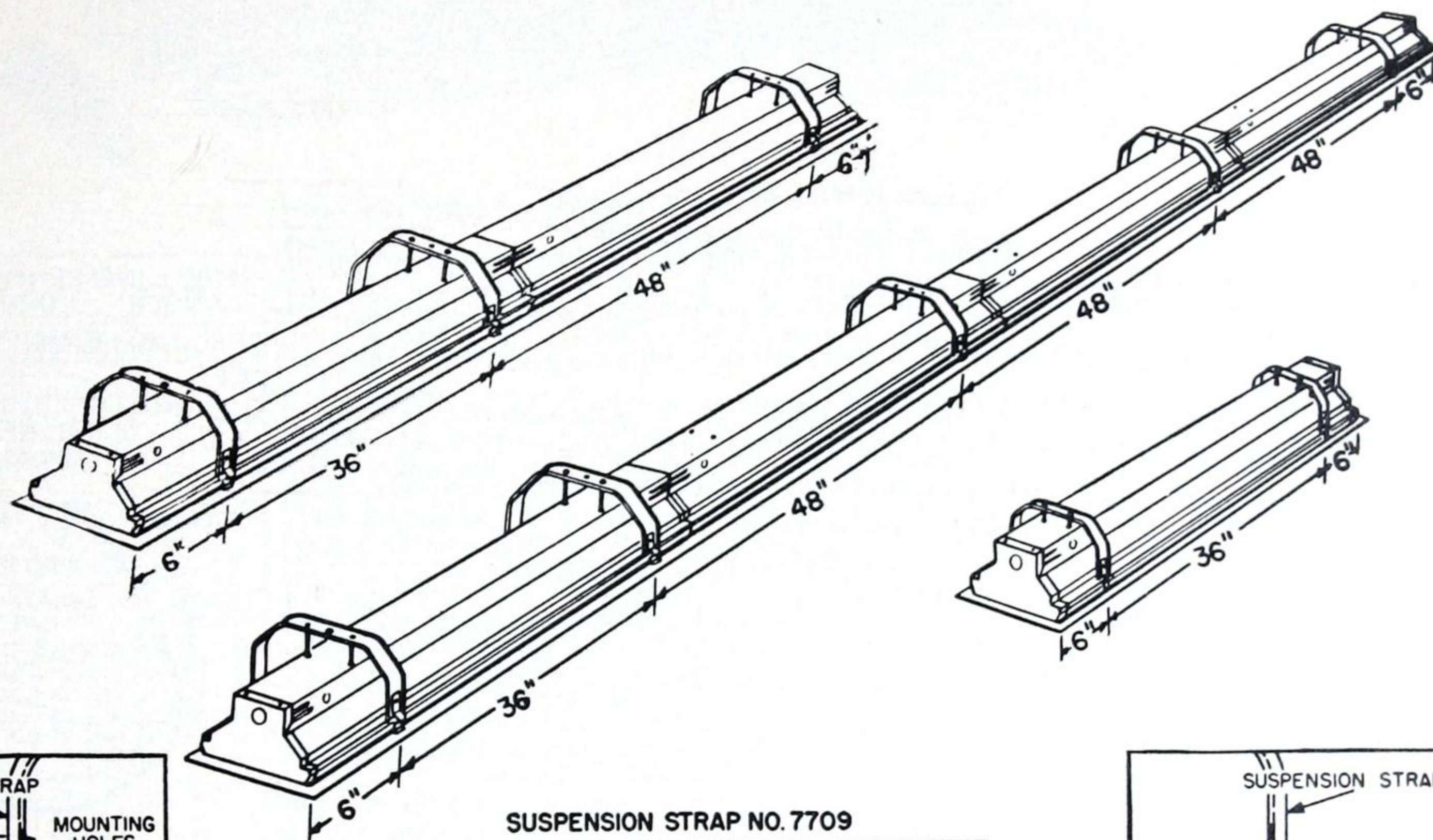

Snap-In Type

The Snap-In type of recessed troffer is specifically designed for installation in Tee-Bar construction type of acoustical ceiling. These fixtures are snapped into position and are supported by the same Tee-Bar as the acoustical ceiling material. No additional supports are required. No cutting of ceiling material is necessary, simply remove the required number of ceiling blocks and insert the Snap-In recessed fixture.

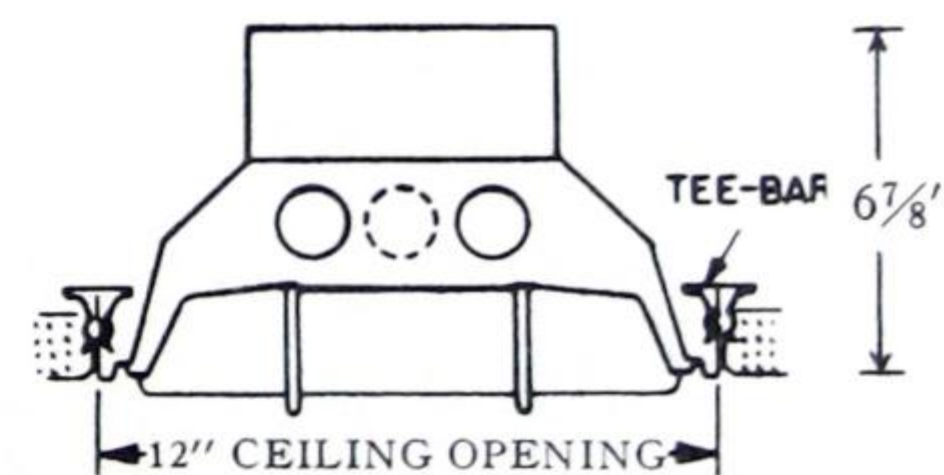
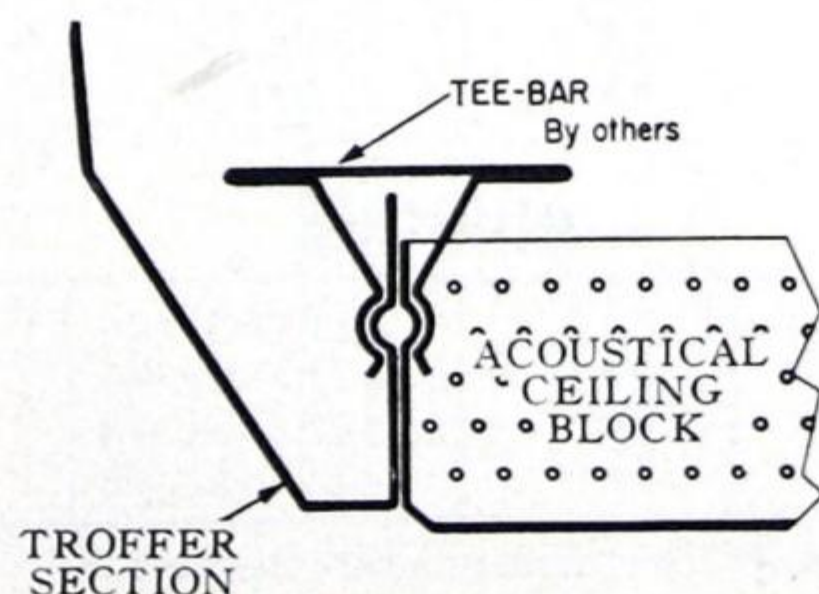
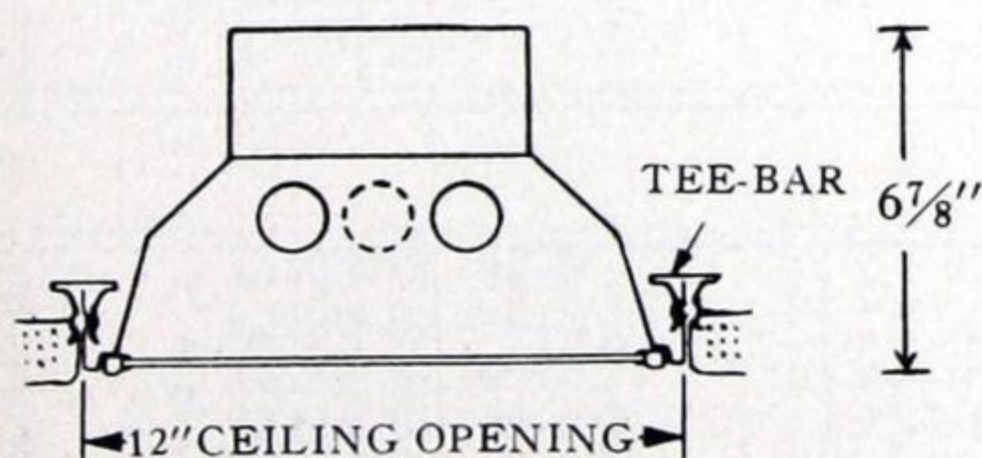



FLUORESCENT AND SLIMLINE RECESSED TROFFERS

Day-Brite Snap-In Type Recessed Troffers With Hinged Boxco Louvers

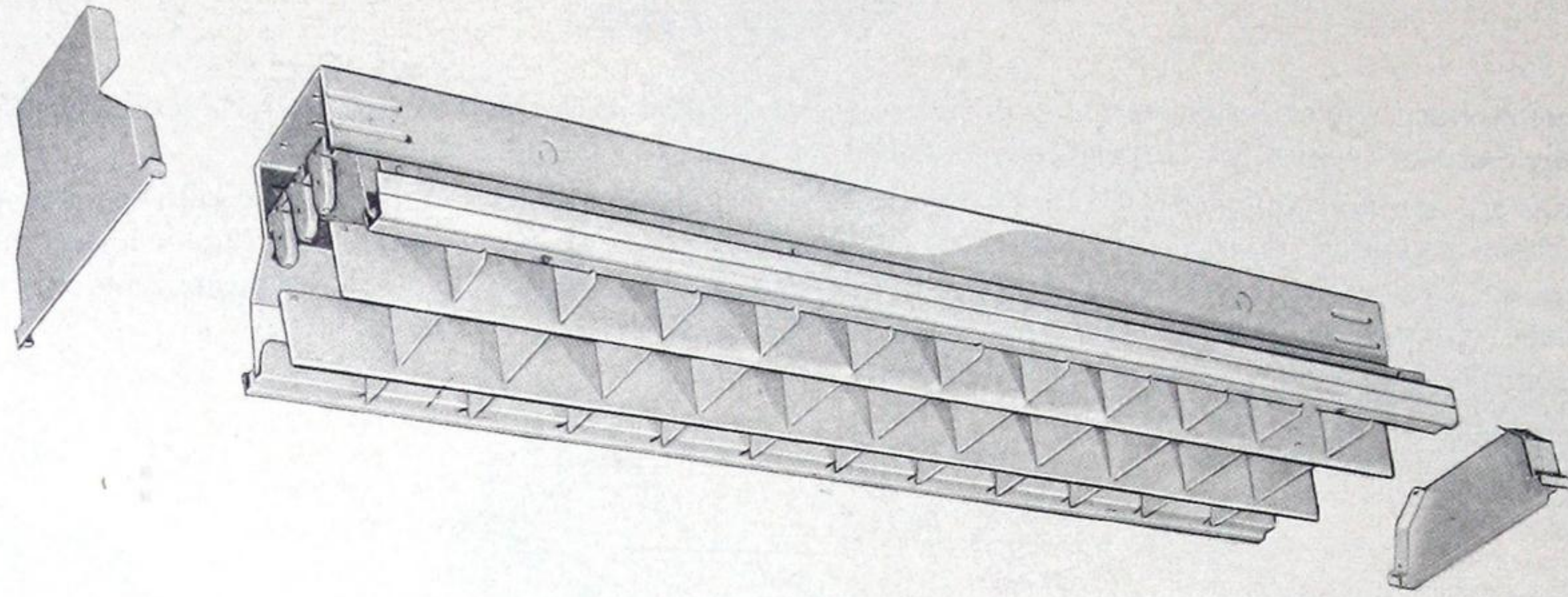

The Snap-In Type Troffer is specifically designed for installation in Tee-Bar acoustical ceilings.

BASIC UNIT—The Snap-In type basic unit can be mounted individually or as the first fixture in a continuous row. The basic unit consists of the reflector assembly, mounting frame and wiring channel for two or three lamp 40 watt standard fluorescent lamps or two or three lamp 48" T-12 or 96" T-12 Slimline lamps.

EXTENSION UNIT—One or more Snap-In type extension units can be used in conjunction with a basic unit to make up a continuous row. The extension units are supplied with coupling plates, the end plate from the first basic unit is used to complete the last extension unit of the continuous row.

Both the basic and extension units are complete with ballasts, starters for fluorescent units, and include wiring.

END PLATES—The end plates are of die-formed steel construction. They contain knock-outs for through wiring and a special steel baffle strip to prevent light leaks at the ends of the unit. Two end plates supplied with each basic unit.

COUPLING PLATES—The die formed coupling plates ensure rigidity and correct alignment where units are mounted in continuous rows. A special steel baffle strip is also provided to prevent light leaks at the ends of the unit.

LOUVER—The Boxco louver assembly of double wall construction is designed to provide correct shielding, rigidity and easy maintenance. To simplify installation and maintenance a separable hinge arrangement permits attachment of louver and allows for hinging from either side of the unit.

SHIELDING LENGTHWISE 20° ANGLE CROSSWISE 35°		SPACING 1xMH		EFF 53.0%		
M.F.	BOXCO LOUVER FLUORESCENT 2x40W LAMP	0%↑		53.0%↓		
G.75						
M.70						
P.65						
CEILING	75%		50%			
WALLS	50%	30%	10%	50%	30%	10%
ROOM INDEX	COEFFICIENT OF UTILISATION					
J	.28	.26	.24	.27	.25	.23
I	.34	.32	.30	.33	.31	.29
H	.37	.35	.34	.36	.34	.33
G	.40	.38	.37	.39	.37	.36
F	.42	.40	.38	.40	.38	.37
E	.44	.43	.41	.43	.42	.40
D	.47	.45	.43	.46	.44	.42
C	.49	.46	.45	.47	.45	.44
B	.50	.47	.47	.48	.46	.45
A	.51	.49	.48	.49	.47	.46

SHIELDING LENGTHWISE 20° ANGLE CROSSWISE 35°		SPACING 1.2xMH		EFF 57.0%		
M.F.	BOXCO LOUVER SLIMLINE 2x96" T12 LAMPS	0%↑		57.0%↓		
G.75						
M.70						
P.65						
CEILING	75%		50%			
WALLS	50%	30%	10%	50%	30%	10%
ROOM INDEX	COEFFICIENT OF UTILISATION					
J	.29	.27	.25	.28	.26	.24
I	.35	.33	.31	.34	.32	.30
H	.37	.36	.35	.37	.35	.34
G	.41	.39	.38	.40	.38	.37
F	.43	.41	.39	.41	.39	.38
E	.45	.44	.42	.44	.43	.41
D	.49	.46	.44	.46	.45	.43
C	.51	.47	.46	.49	.46	.45
B	.52	.48	.48	.50	.47	.46
A	.53	.50	.49	.51	.48	.47

Fluorescent

Catalogue No.*	Lamp Watts (T-12)	Cycles	Length	Component Parts			
				Troffer	Boxco Louver	End Plate	Coupling Plate
Complete Unit				Body No.*	No. 42224	No. 7685	No. 7687
42240-DF-B	2 x 40	25/60	48"	1, 42200-DF	1	2	0
42240-DF-E	2 x 40	25/60	48"	1, 42200-DF	1	0	1
42240-60-B	2 x 40	60	48"	1, 42200-60	1	2	0
42240-60-E	2 x 40	60	48"	1, 42200-60	1	0	1
42240-60-IS-B	2 x 40	60	48"	1, 42200-60-IS	1	2	0
42240-60-IS-E	2 x 40	60	48"	1, 42200-60-IS	1	0	1
42340-60-B	3 x 40	60	48"	1, 42300-60	1	2	0
42340-60-E	3 x 40	60	48"	1, 42300-60	1	0	1

Slimline

42240-SL-96-B	2 x 72	60	96"	1, 42200-SL-96	2	2	0
42240-SL-96-E	2 x 72	60	96"	1, 42200-SL-96	2	0	1
42240-SL-48-B	2 x 36	60	48"	1, 42200-SL-48	1	2	0
42240-SL-48-E	2 x 36	60	48"	1, 42200-SL-48	1	0	1

*Suffixes—"B" basic unit, "E" extension unit, "60IS" for instant start operation.



FLUORESCENT AND SLIMLINE RECESSED TROFFERS

Day-Brite Snap-In Type Recessed Troffers With Hinged Alba-Lite Diffusing Glass Panel

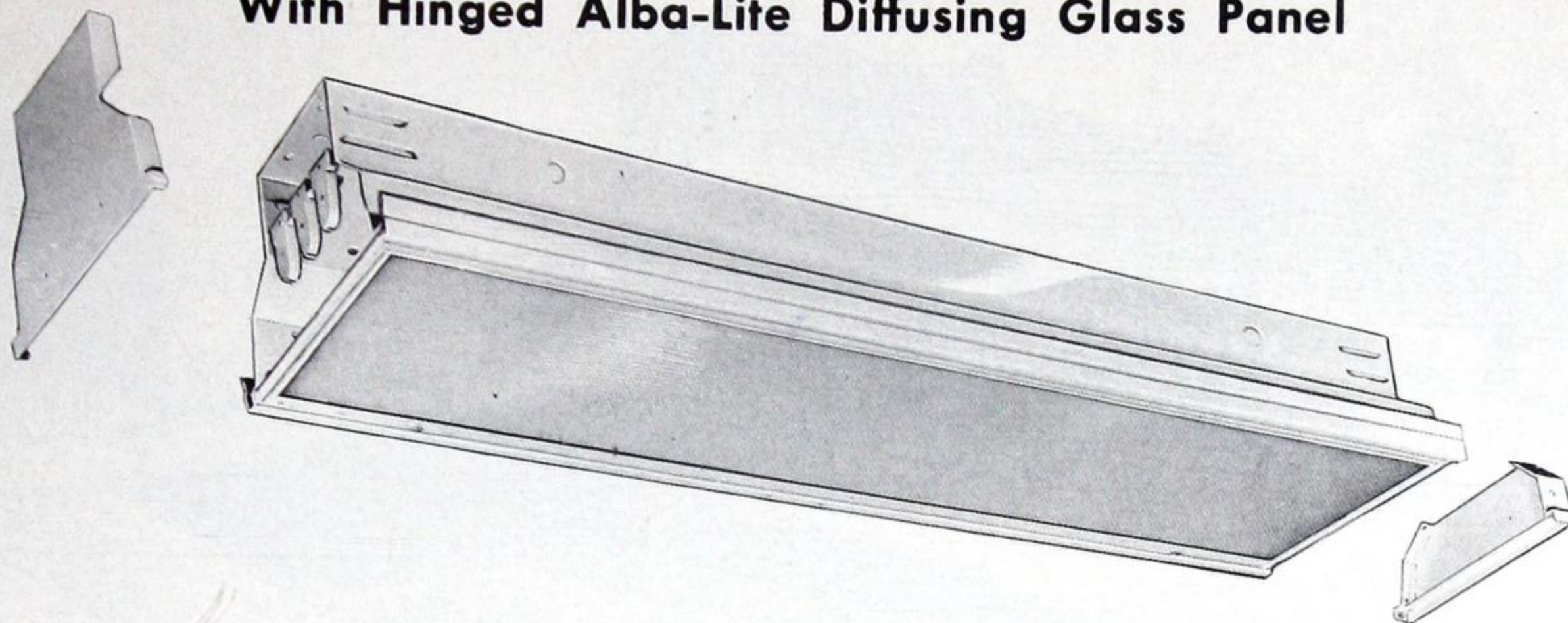

The Snap-In Type Troffer is specifically designed for installation in Tee-Bar acoustical ceilings.

BASIC UNIT—The Snap-In type basic unit can be mounted individually or as the first fixture in a continuous row. The basic unit consists of the reflector assembly, mounting frame and wiring channel for two or three lamp 40 watt standard fluorescent lamps or two or three lamp 48" T-12 or 96" T-12 Slimline lamps.

EXTENSION UNIT—One or more Snap-In type extension units can be used in conjunction with a basic unit to make up a continuous row. The extension units are supplied with coupling plates, the end plate from the first basic unit is used to complete the last extension unit of the continuous row.

Both the basic and extension units are complete with ballasts, starters for fluorescent units, and include wiring.

END PLATES—The end plates are of die-formed steel construction. They contain knock-outs for through wiring and a special steel baffle strip to prevent light leaks at the ends of the unit. Two end plates supplied with each basic unit.

COUPLING PLATES—The die formed coupling plates ensure rigidity and correct alignment where units are mounted in continuous rows. A special steel baffle strip is also provided to prevent light leaks at the ends of the unit.

GLASS PANEL

The Albalite diffusing glass panel is supported in a die rolled frame. To simplify installation and maintenance a separable hinge arrangement permits attachment of frame and allows for hinging from either side of the unit.

SPACING 1.0xMH		EFF 56.0%	
M.F.	DIFFUSING PANEL	0% ↓	
G.75	FLUORESCENT	56.0%	
M.70	2x40W		
P.65			
CEILING	75%	50%	
WALLS	50% 30% 10%	50%	30% 10%
ROOM INDEX	COEFFICIENT OF UTILISATION		
J	.28	.25	.22
I	.35	.32	.30
H	.38	.36	.34
G	.41	.38	.37
F	.43	.41	.38
E	.46	.44	.42
D	.49	.47	.45
C	.51	.49	.46
B	.52	.50	.49
A	.54	.52	.50

SPACING 1.2xMH		EFF 58.3%	
M.F.	DIFFUSING PANEL	0% ↓	
G.75	SLIMLINE	58.3%	
M.70	2x96" T12		
P.65			
CEILING	75%	50%	
WALLS	60% 30% 10%	50%	30% 10%
ROOM INDEX	COEFFICIENT OF UTILISATION		
J	.29	.26	.23
I	.36	.33	.31
H	.39	.37	.35
G	.42	.39	.38
F	.44	.42	.39
E	.47	.45	.43
D	.50	.48	.46
C	.52	.50	.47
B	.53	.51	.50
A	.55	.53	.51

Fluorescent

Catalogue No.*	Lamp Watts (T-12)	Cycles	Length	Component Parts			
				Troffer Body No.*	Diffusing Glass Panel No. 42223	End Plate No. 7685	Coupling Plate No. 7687
42230-DF-B	2 x 40	25/60	48"	1, 42200-DF	1	2	0
42230-DF-E	2 x 40	25/60	48"	1, 42200-DF	1	0	1
42230-60-B	2 x 40	60	48"	1, 42200-60	1	2	0
42230-60-E	2 x 40	60	48"	1, 42200-60	1	0	1
42230-60-IS-B	2 x 40	60	48"	1, 42200-60-IS	1	2	0
42230-60-IS-E	2 x 40	60	48"	1, 42200-60-IS	1	0	1
42330-60-B	3 x 40	60	48"	1, 42300-60	1	2	0
42330-60-E	3 x 40	60	48"	1, 42300-60	1	0	1

Slimline

42230-SL-96-B	2 x 72	60	96"	1, 42200-SL-96	2	2	0
42230-SL-96-E	2 x 72	60	96"	1, 42200-SL-96	2	0	1
42230-SL-48-B	2 x 36	60	48"	1, 42200-SL-48	1	2	0
42230-SL-48-E	2 x 36	60	48"	1, 42200-SL-48	1	0	1

*Suffixes—"B" basic unit, "E" extension unit, "60IS" for instant start operation.



FLUORESCENT AND SLIMLINE RECESSED TROFFERS

Day-Brite Snap-In Type Recessed Troffers with Hinged Light-Weight Prismatic Lens Panel

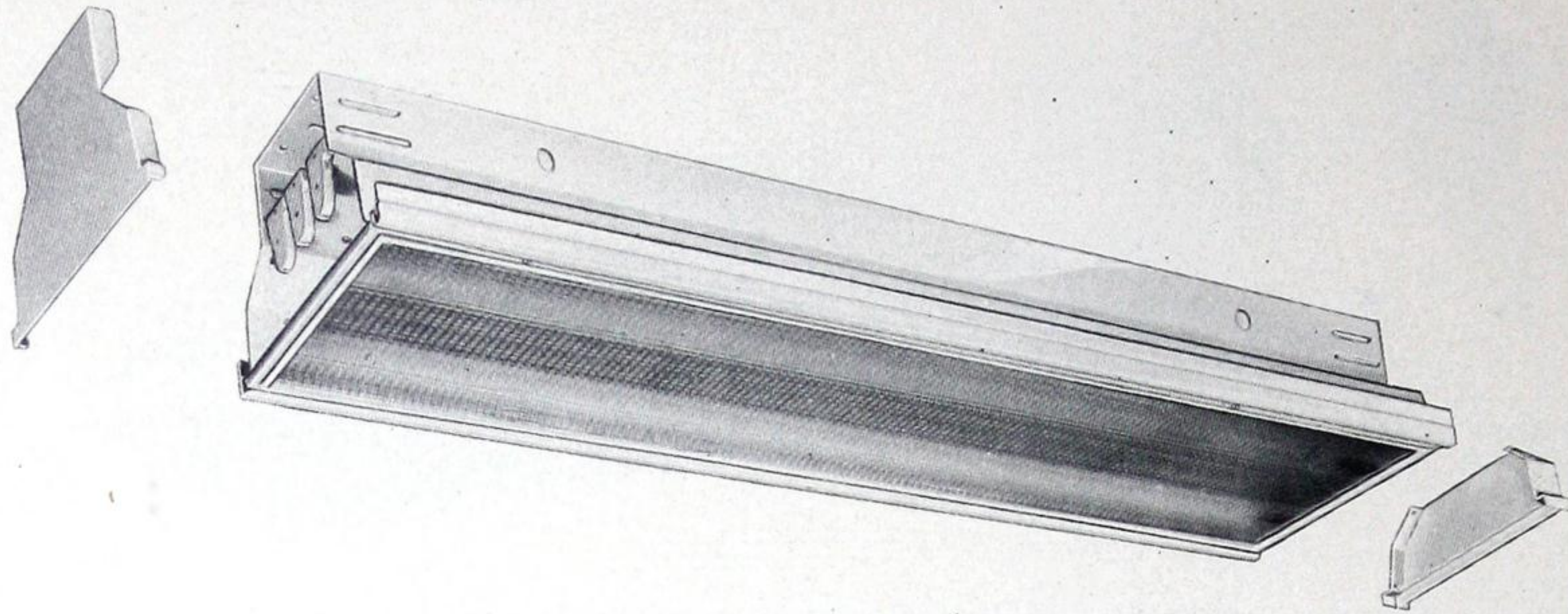

The Snap-In Type Troffer is specifically designed for installation in Tee-Bar acoustical ceilings.

BASIC UNIT—The Snap-In type basic unit can be mounted individually or as the first fixture in a continuous row. The basic unit consists of the reflector assembly, mounting frame and wiring channel for two or three lamp 40 watt standard fluorescent lamps or two or three lamp 48" T-12 or 96" T-12 Slimline lamps.

EXTENSION UNIT—One or more Snap-In type extension units can be used in conjunction with a basic unit to make up a continuous row. The extension units are supplied with coupling plates, the end plate from the first basic unit is used to complete the last extension unit of the continuous row.

Both the basic and extension units are complete with ballasts, starters for fluorescent units, and include wiring.

END PLATES—The end plates are of die-formed steel construction. They contain knock-outs for through wiring and a special steel baffle strip to prevent light leaks at the ends of the unit. Two end plates supplied with each basic unit.

COUPLING PLATES—The die formed coupling plates ensure rigidity and correct alignment where units are mounted in continuous rows. A special steel baffle strip is also provided to prevent light leaks at the ends of the unit.

LENS PANEL

The light-weight prismatic lens panel is supported in a die rolled frame. To simplify installation and maintenance a separable hinge arrangement permits attachment of frame and allows for hinging from either side of the unit.

SPACING 1.0xMH		EFF 61.7%				
M.F.	LENS PANEL FLUORESCENT 2x40W	0% ↑ 61.7% ↓				
G.75						
M.70						
P.65						
CEILING	75%	50%				
WALLS	50%	30%	10%	50%		
ROOM INDEX	COEFFICIENT OF UTILISATION					
J	.33	.30	.27	.31	.29	.27
I	.39	.36	.36	.38	.36	.34
H	.42	.40	.39	.41	.40	.39
G	.45	.43	.42	.45	.42	.42
F	.48	.46	.43	.46	.45	.43
E	.50	.49	.47	.48	.48	.46
D	.54	.51	.49	.52	.51	.49
C	.55	.53	.51	.54	.52	.51
B	.56	.54	.53	.55	.53	.52
A	.57	.55	.54	.56	.54	.53

SPACING 1.2xMH		EFF 63.5%				
M.F.	LENS PANEL SLIMLINE 2x96" T12	0% ↑ 63.5% ↓				
G.75						
M.70						
P.65						
CEILING	75%	50%				
WALLS	50%	30%	10%	50%		
ROOM INDEX	COEFFICIENT OF UTILISATION					
J	.35	.32	.31	.34	.32	.31
I	.42	.40	.39	.41	.39	.39
H	.45	.44	.44	.44	.43	.43
G	.49	.47	.47	.48	.46	.45
F	.51	.50	.48	.49	.48	.47
E	.54	.53	.51	.53	.51	.50
D	.57	.55	.53	.55	.54	.53
C	.58	.57	.54	.57	.55	.54
B	.59	.57	.57	.58	.56	.55
A	.60	.58	.58	.58	.57	.56

Fluorescent

Catalogue No.*	Lamp Watts (T-12)	Cycles	Length	Component Parts			
				Troffer Body No.*	Prismatic Lens Panel No. 42225	End Plate No. 7685	Coupling Plate No. 7687
42250-DF-B	2 x 40	25/60	48"	1, 42200-DF	1	2	0
42250-DF-E	2 x 40	25/60	48"	1, 42200-DF	1	0	1
42250-60-B	2 x 40	60	48"	1, 42200-60	1	2	0
42250-60-E	2 x 40	60	48"	1, 42200-60	1	0	1
42250-60-IS-B	2 x 40	60	48"	1, 42200-60-IS	1	2	0
42250-60-IS-E	2 x 40	60	48"	1, 42200-60-IS	1	0	1
42350-60-B	3 x 40	60	48"	1, 42300-60	1	2	0
42350-60-E	3 x 40	60	48"	1, 42300-60	1	0	1

Slimline

42250-SL-96-B	2 x 72	60	96"	1, 42200-SL-96	2	2	0
42250-SL-96-E	2 x 72	60	96"	1, 42200-SL-96	2	0	1
42250-SL-48-B	2 x 36	60	48"	1, 42200-SL-48	1	2	0
42250-SL-48-E	2 x 36	60	48"	1, 42200-SL-48	1	0	1

*Suffixes—"B" basic unit, "E" extension unit, "60IS" for instant start operation.



RECESSED TROFFERS

Curtis Recessed Troffers

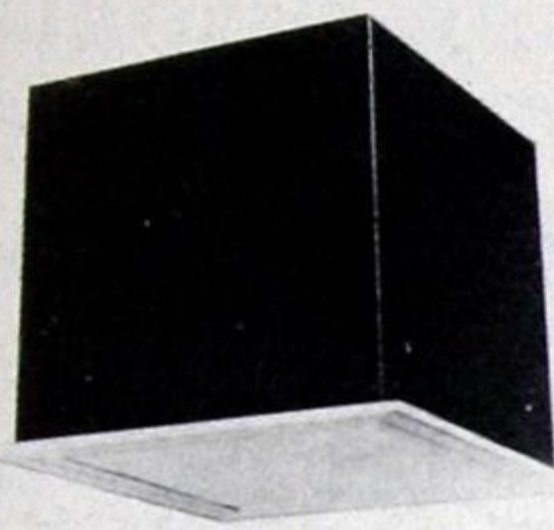

INCANDESCENT RECESSED UNIT

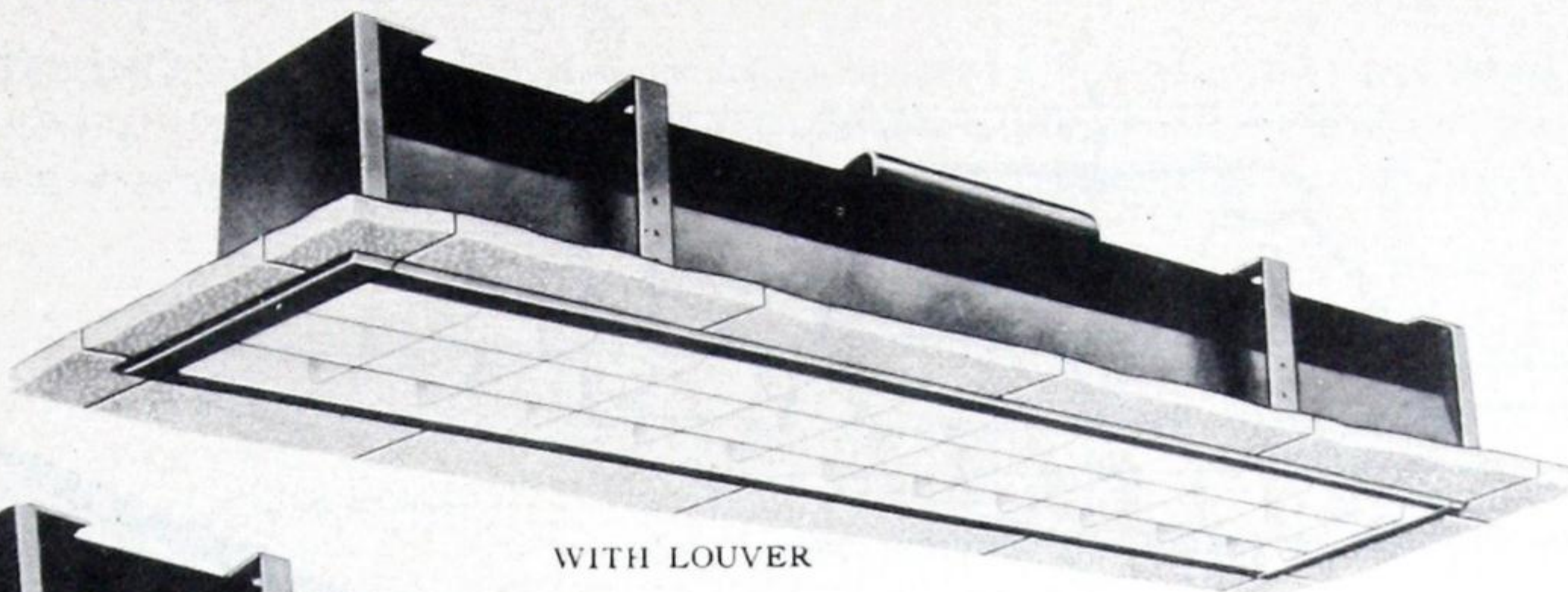

WITH LOUVER

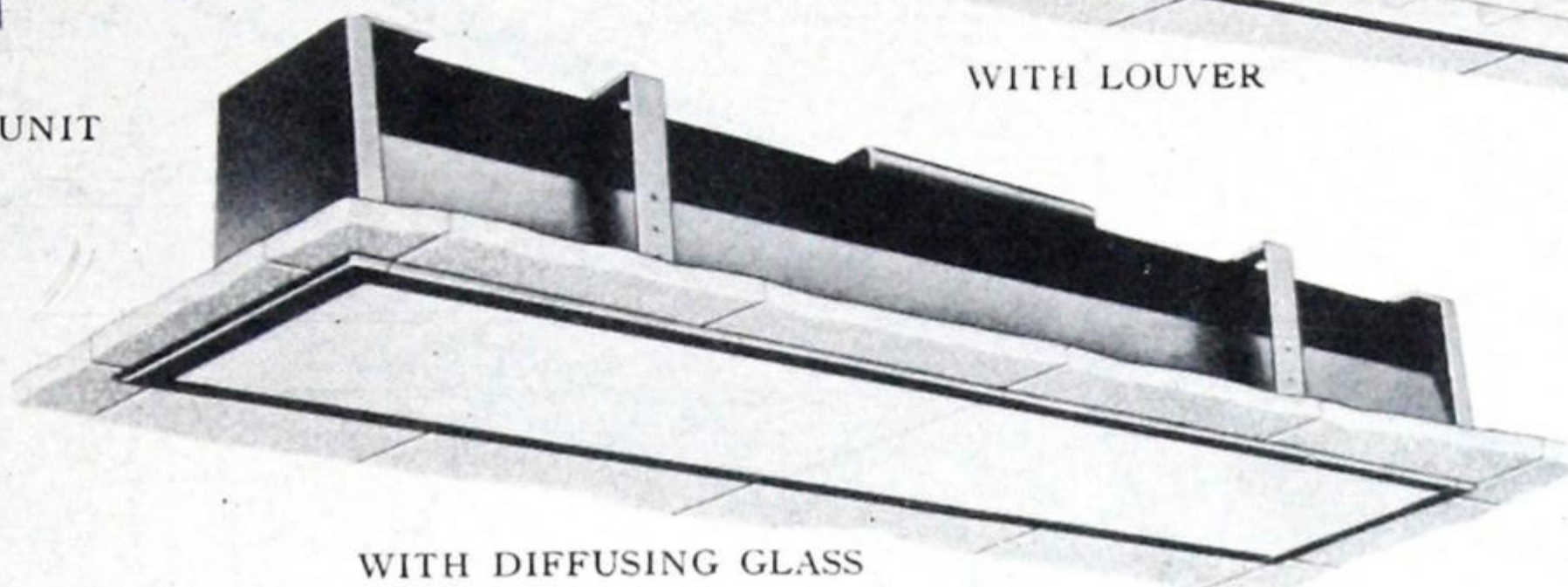

WITH DIFFUSING GLASS

Curtis recessed troffers are particularly suitable for rooms with acoustical or other suspended ceilings. The unit is modern in design, low in brightness, highly efficient. It may be mounted in continuous rows, patterns or squares, and may be used to advantage with incandescent spot units. The troffer is equipped with side flanges, and is easy to install and maintain.

REFLECTORS: Of heavy grade aluminum with fluracite finish. The reflecting surface is a synthetic material, glossy white and mineral hard, fluracite possesses unusually high reflectivity and is easily cleaned with soap and water.

DIMENSIONS: Each unit is exactly 48 inches long and fits into a 12-inch slot in the ceiling. Width 13 inches at bottom over flanges, 9 1/4 inches above finished ceiling required for recessing. The slot in ceiling should be 1/4 inch longer than multiples of 48 inches to make installation easier.

MATERIAL: Heavy grade aluminum reflectors, louvers, wiring channel, steel end plates and intermediate plates.

FINISH: White fluracite reflectors, louvers, end plates and intermediate plates. Wiring channel painted black outside.

CORNER TROFFER UNIT

Designed for use with acoustic or other suspended ceilings where a continuous band of fluorescent light is desired. Can be easily adapted to various ceiling patterns to produce a continuous corner effect. Corner Troffers are available with either glass bottoms or louvers similar to the standard units. For detailed information, CONSULT YOUR LOCAL NORTHERN ELECTRIC OFFICE.

SHIELDING LENGTHWISE 25°		CROSSWISE 35°	
SPACING 1xMH		EFF 63.2%	
M.F.	1722	0% ↑	
G.80		↓	
M.75		63.2%	
P.70		↓	
CEILING	75%	50%	
WALLS	50% 30% 10%	30% 10%	
ROOM INDEX	COEFFICIENT OF UTILISATION		
J	.35	.32	.31
I	.42	.40	.39
H	.45	.44	.43
G	.48	.47	.46
F	.51	.49	.48
E	.53	.52	.51
D	.56	.54	.53
C	.58	.56	.55
B	.59	.57	.56
A	.60	.59	.58

Cat. No.*	Lamp Watts	Description	Cycles
With Diffusing Glass Panel			
1752-C	2-40	Basic	60
1752-CE	2-40	Extension	60
1753-C	3-40	Basic	60
1753-CE	3-40	Extension	60
1752-F	2-40	Basic	25
1752-FE	2-40	Extension	25
1753-YF	3-40	Basic	25
1753-YFE	3-40	Extension	25
With Louver			
1722-C	2-40	Basic	60
1722-CE	2-40	Extension	60
1723-C	3-40	Basic	60
1723-CE	3-40	Extension	60
1722-F	2-40	Basic	25
1722-FE	2-40	Extension	25
1723-YF	3-40	Basic	25
1723-YFE	3-40	Extension	25

SPACING 1xMH		EFF 59.3%	
M.F.	1752	0% ↑	
G.80		↓	
M.75		59.3%	
P.70		↓	
CEILING	75%	50%	
WALLS	50% 30% 10%	30% 10%	
ROOM INDEX	COEFFICIENT OF UTILISATION		
J	.31	.28	.27
I	.38	.36	.34
H	.41	.39	.38
G	.44	.43	.41
F	.46	.45	.44
E	.49	.48	.47
D	.52	.50	.49
C	.54	.52	.50
B	.56	.53	.52
A	.56	.54	.53

*For instant start operation add suffix "IS" to catalogue number.

Incandescent Recessed Units

B-431A: Alternate-with special flanges for application in a continuous fluorescent troffer run and placed alternate to each troffer unit.
B-431B: Basic-with special flanges for installation as a single recessed housed unit.

B-431C: Corner-with special flanges for right or left hand corner application in corner of a rectangular fluorescent troffer run.

B-431D: Dead-end-with special flange for use at the end of a fluorescent troffer run.

NOTE:—To specify the above units with louvers add suffix "L" to above reference numbers.

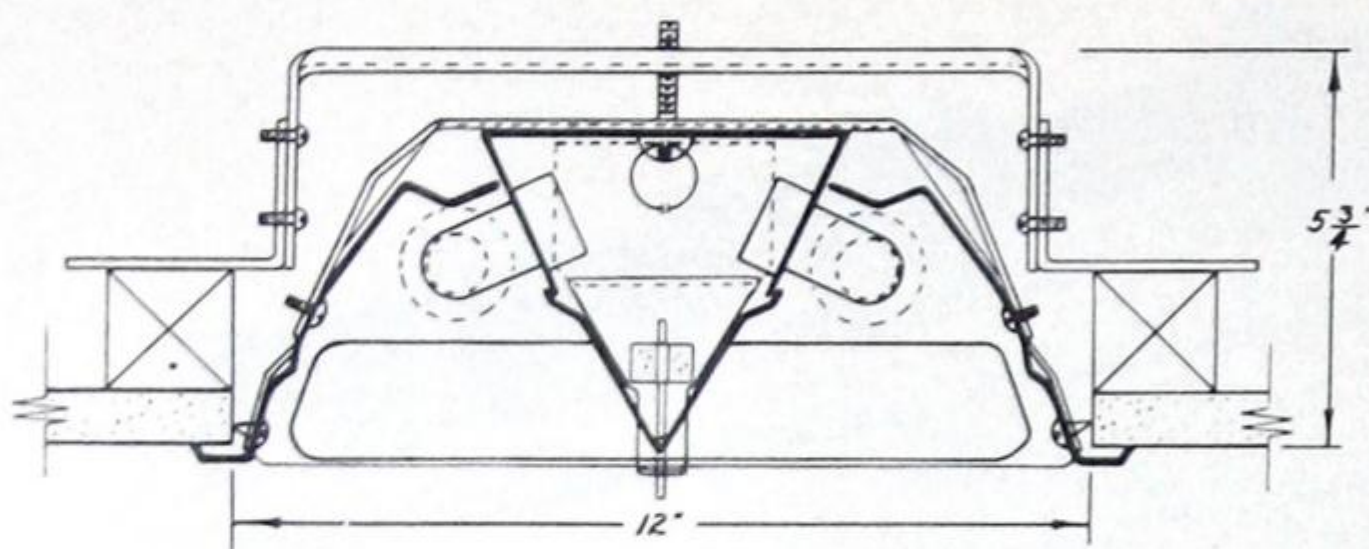
RECESSED TROFFERS
Curtis Shallow Recessed Troffers

FOR PLASTER OR FIBROUS ACOUSTICAL TILE CEILING

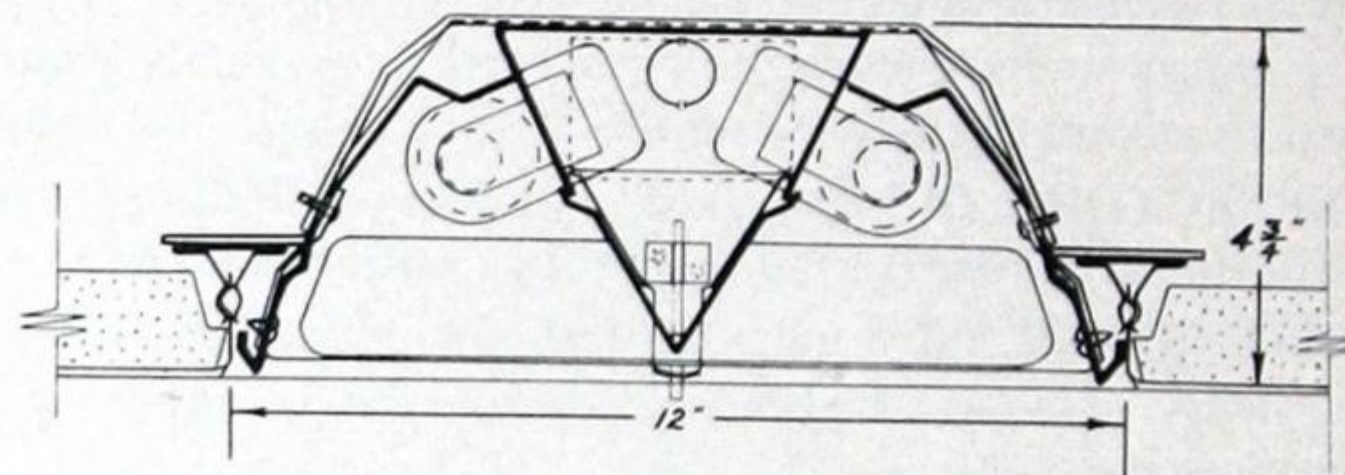
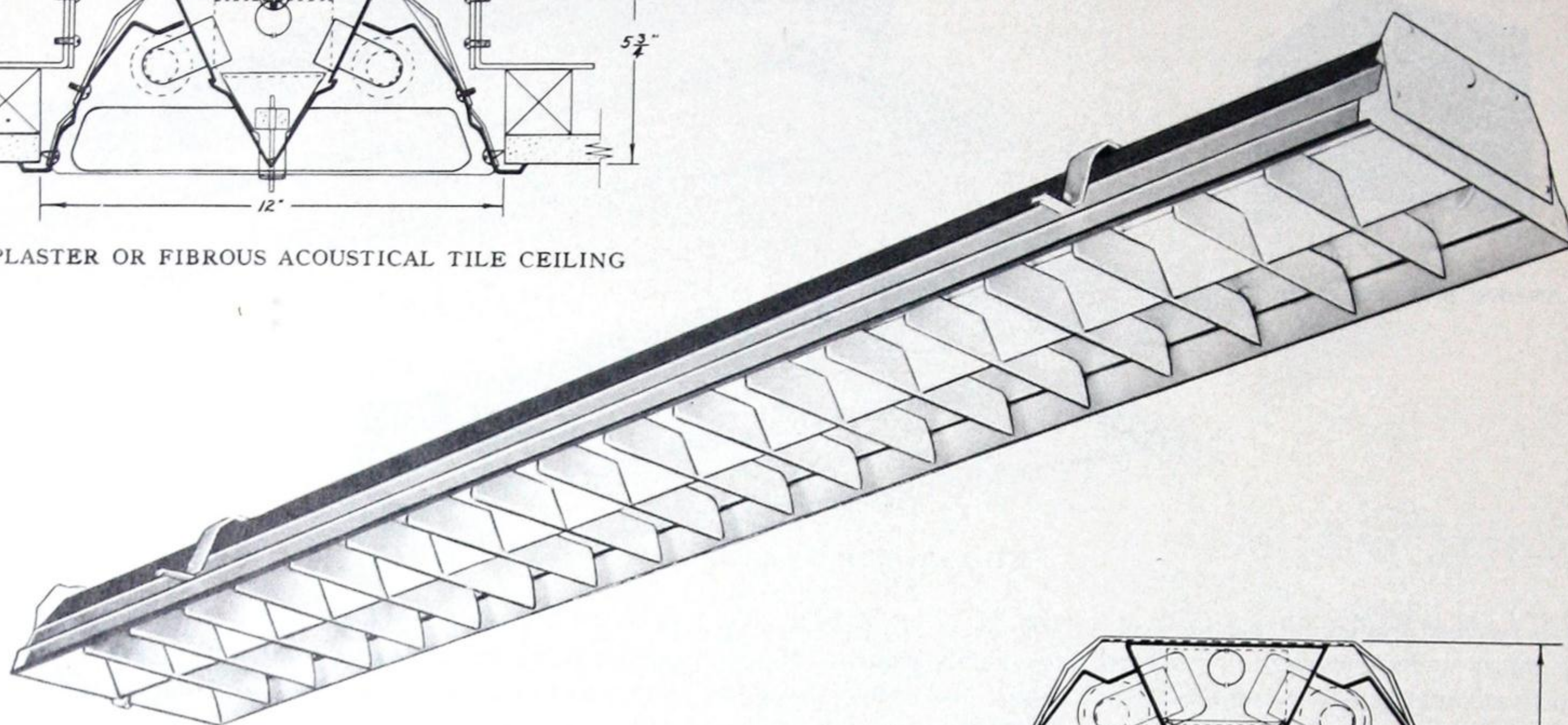

FOR T-BAR ACOUSTICAL CEILING

Curtis Recessed Shallow Louvered Troffers, for use with two slimline or two standard 40-watt fluorescent lamps, are designed specifically for shallow recessing depths. They are used where interiors require the attractive appearance of recessed lighting, but ceiling depths present difficulties. These new Troffers, designed for eye-comfort and high efficiency, provide a high level of efficient illumination, and are engineered to direct a maximum amount of light to the working plane.

Shallow Troffers are modern in design, low in brightness, and are ideally suited for installations where a high level of shielded, shadowless illumination is necessary. These fixtures may be mounted singly or in continuous rows, patterns, or squares.

Shallow Troffers can be used in plaster or T-Bar acoustical ceilings. For plaster ceilings, recessing depths vary from 5 1/4" to 6"; for T-Bar ceiling construction depth is approximately 4 3/4".

These units are available in alzak aluminum or with fluracite-finish.

ALZAK ALUMINUM TROFFER—Within the shielded zone maximum brightness does not exceed 1.3 candles per square inch.

FLURACITE-FINISH TROFFER—Within the shielded zone maximum brightness does not exceed 1.5 candles per square inch.

Available in individual lengths of 48", 72", 96". When using this fixture in continuous rows, add 1/8" to overall length of lamps for each continuous row. The troffer fits into a 12" slot in the ceiling permitting alignment of reflectors with acoustical ceiling patterns.

Weight installed approximately 6 lbs. per foot.

WIRING

Luminaires are regularly supplied wired for 110-125 volt 60 cycle AC circuits with high power factor ballasts. FS-40 starters are supplied for use with 40-watt bi-pin fluorescent lamps, conventional start ballasts. Slimline units are equipped with series sequence ballasts.

One wire entrance is sufficient for each circuit in a continuous row.

CONTINUOUS ROWS

Curtis Recessed Shallow Louvered Troffers may be mounted singly or in continuous rows. Add 1/8 inch to overall length of lamps for each continuous row. For plaster ceilings, one basic unit is required per row, balance are extension units.



RECESSED TROFFERS

Curtis Shallow Recessed Troffers

CONSTRUCTION AND EASE OF MAINTENANCE—Unit has specially designed louver equipped with catches and safety chains for ease of relamping. Finger-tip pressure on catches at either end of fixture allows louver assembly to hang down on one or both chains. Troffer can be relamped from either end by releasing catch and letting louver hang on one chain. In continuous rows, two units can be relamped from one ladder position.

Complete louver assembly hangs on chains for thorough cleaning and easy access to ballast and wiring. The louver is out of the way yet held securely.

To replace louver assembly, simply push up into the luminaire re-engaging the catches.

SHIELDING LENGTHWISE 22½°						
ANGLE CROSSWISE 30°						
SPACING 1.0xMH EFF 53.0%						
M.F.	TROFFER					0% ↑
G.80	ALZAK					53.0% ↓
M.75	ALUMINUM					
P.70	200 m.a. SLIMLINE					
CEILING	75%		50%			
WALLS	50%	30%	10%	50%	30%	10%
ROOM INDEX	COEFFICIENT OF UTILISATION					
J	.29	.27	.24	.28	.27	.26
I	.35	.33	.32	.34	.33	.32
H	.37	.36	.36	.37	.35	.35
G	.40	.39	.38	.39	.38	.37
F	.42	.41	.39	.40	.40	.39
E	.44	.43	.42	.43	.42	.41
D	.47	.45	.44	.46	.45	.43
C	.48	.47	.45	.47	.46	.45
B	.49	.47	.47	.48	.46	.46
A	.49	.48	.47	.48	.47	.46

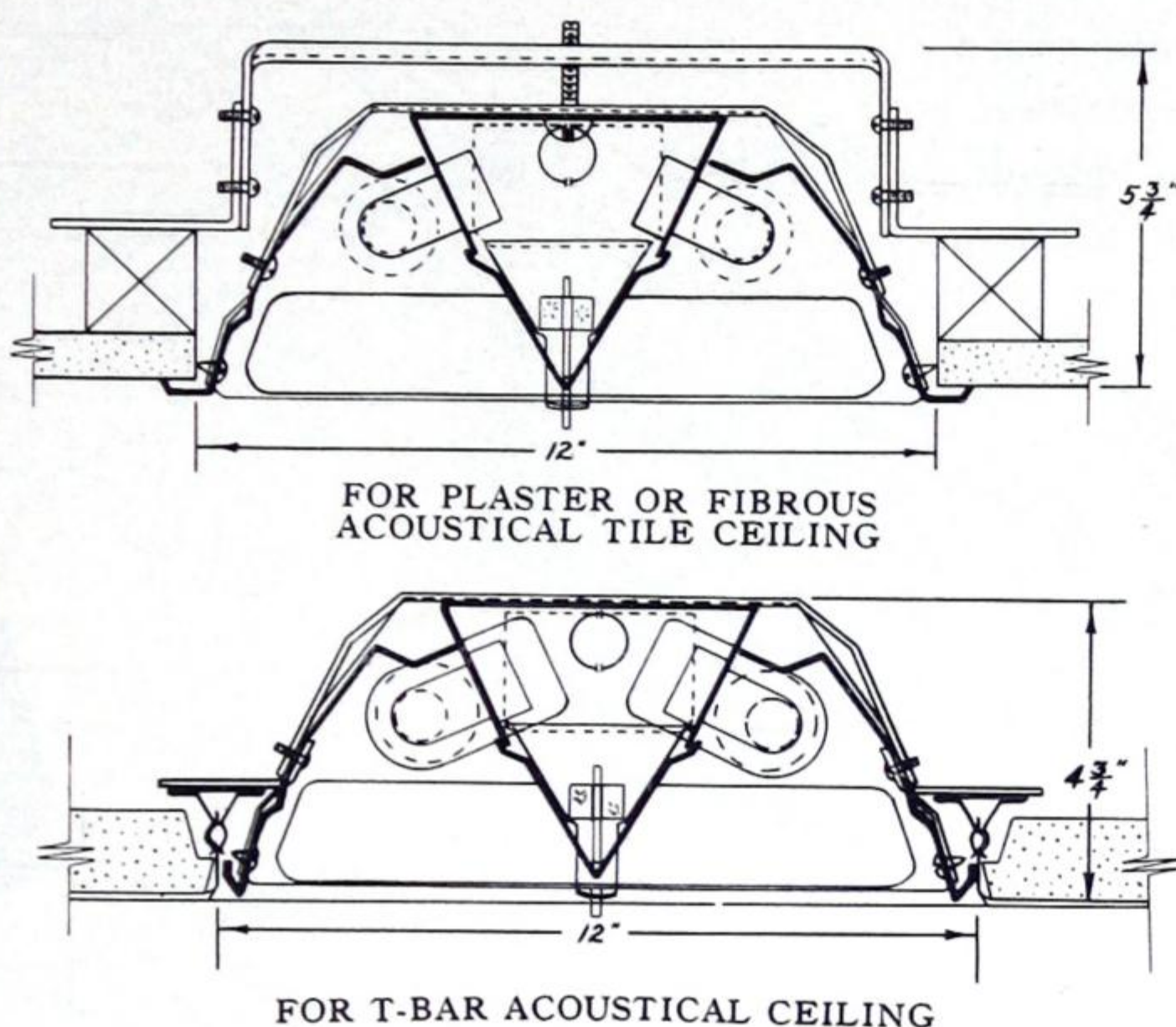

SHIELDING LENGTHWISE 22½°						
ANGLE CROSSWISE 30°						
SPACING 1.0xMH EFF 57.5%						
M.F.	TROFFER					0% ↑
G.80	FLURACITE					57.5% ↓
M.75	FINISH					
P.70	200 m.a. SLIMLINE					
CEILING	75%		50%			
WALLS	50%	30%	10%	50%	30%	10%
ROOM INDEX	COEFFICIENT OF UTILISATION					
J	.32	.29	.26	.31	.29	.28
I	.38	.36	.36	.37	.36	.35
H	.41	.40	.39	.40	.39	.39
G	.44	.43	.42	.43	.42	.41
F	.46	.45	.43	.44	.44	.43
E	.48	.48	.46	.48	.47	.46
D	.52	.50	.48	.50	.49	.48
C	.52	.51	.49	.51	.50	.49
B	.54	.52	.51	.53	.51	.50
A	.54	.53	.53	.53	.52	.51

2 x 40W FLUORESCENT

Catalogue No.							
Fluracite				Alzak Aluminum			
For Plaster or Fibrous Acoustical Tile Ceiling*		For T-Bar Acoustical Tile Ceiling Only		For Plaster or Fibrous Acoustical Tile Ceiling*		For T-Bar Acoustical Tile Ceiling Only	
Standard	Instant Start	Standard	Instant Start	Standard	Instant Start	Standard	Instant Start
6306EPF	6306EPF-IS	6306ETF	6306ETF-IS	6306EPZ	6306EPZ-IS	6306ETZ	6306ETZ-IS

2 LAMP SLIMLINE FLURACITE FINISH

Lamp Current M.A.	Catalogue No.					
	For plaster or Fibrous Acoustical Tile Ceiling*			For T-Bar Acoustical Tile Ceiling Only		
	48"	72"	96"	48"	72"	96"
200	6306BPF	6304BPF	6305BPF	6306BTF	6304BTF	6305BTF
430	6306DPF	6304DPF	6305DPF	6306DTF	6304DTF	6305DTF

2 LAMP SLIMLINE ALZAK ALUMINUM

Lamp Current M.A.	Catalogue No.					
	For Plaster or Fibrous Acoustical Tile Ceiling*			For T-Bar Acoustical Tile Ceiling Only		
	48"	72"	96"	48"	72"	96"
200	6306BPZ	6304BPZ	6305BPZ	6306BTZ	6304BTZ	6305BTZ
430	6306DPZ	6304DPZ	6305DPZ	6306DTZ	6304DTZ	6305DTZ

*Units for mounting in plaster or fibrous acoustical tile ceiling only are available as basic or extension units for continuous row mounting. Specify one basic unit for each continuous row, the balance to be specified as extension units.



RECESSED TROFFERS

Lighting Materials Aluminum Recessed Troffers

This unit is suitable for any commercial lighting application and may be installed in plaster, acoustic or other types of ceiling construction. The standard unit is equipped with louvers but units equipped with diffusing glass panels are available if specified. Available for one, two or three fluorescent lamps 20 watt and 40 watt.

CONSTRUCTION

The units consist of 4 basic parts, a wiring pan incorporating a wiring channel to house all circuit wiring and supporting straps, the electrical pan which holds the ballast lampholders, starters and fixture wiring, the reflector and hinged louver or diffusing glass panel. The entire fixture is of aluminum construction.

FINISH

The complete fixture has the patented "Alumilite" finish. "Alumilite" is an electro chemical process on aluminum which produces a hard non-tarnishing satin silver surface, easy to clean, highly efficient reflection surface which will not deteriorate with age.

MOUNTING

The mounting straps forming part of the wiring pan are adaptable for suspending the unit in any type of ceiling.

WIRING

Individual units are supplied completely wired and equipped with best quality ballasts and electrical components.

SPOTLIGHT UNIT

The spotlight unit using an R40 lamp is adjustable. It may be used individually, at the ends of or as intermediate units in a continuous row. The wiring pan conforms to the same design of the troffer unit facilitating the simplification of wiring of continuous rows. The unit fits into an area 12" x 12" x 6 3/4".

DAWN "DESIGN 19"

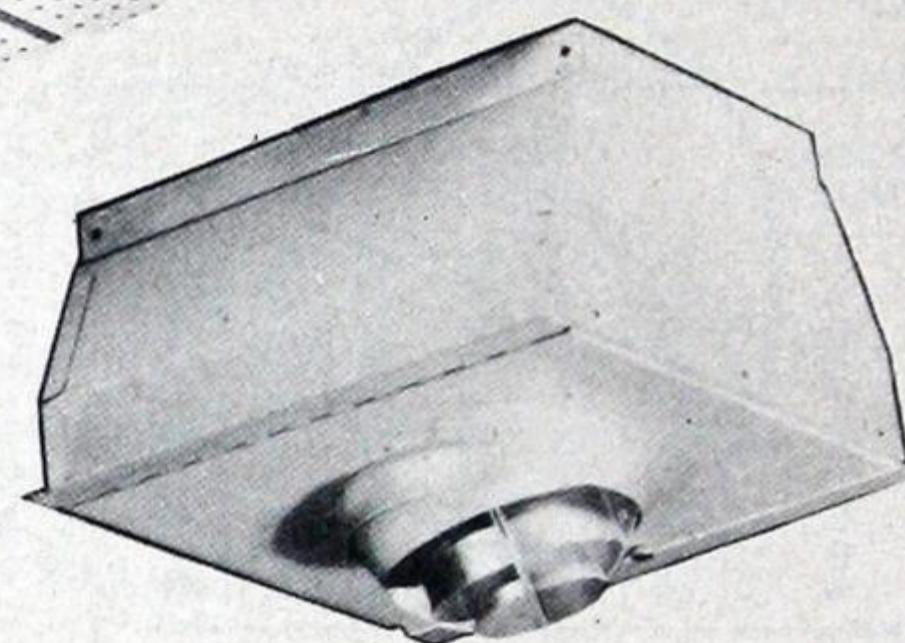
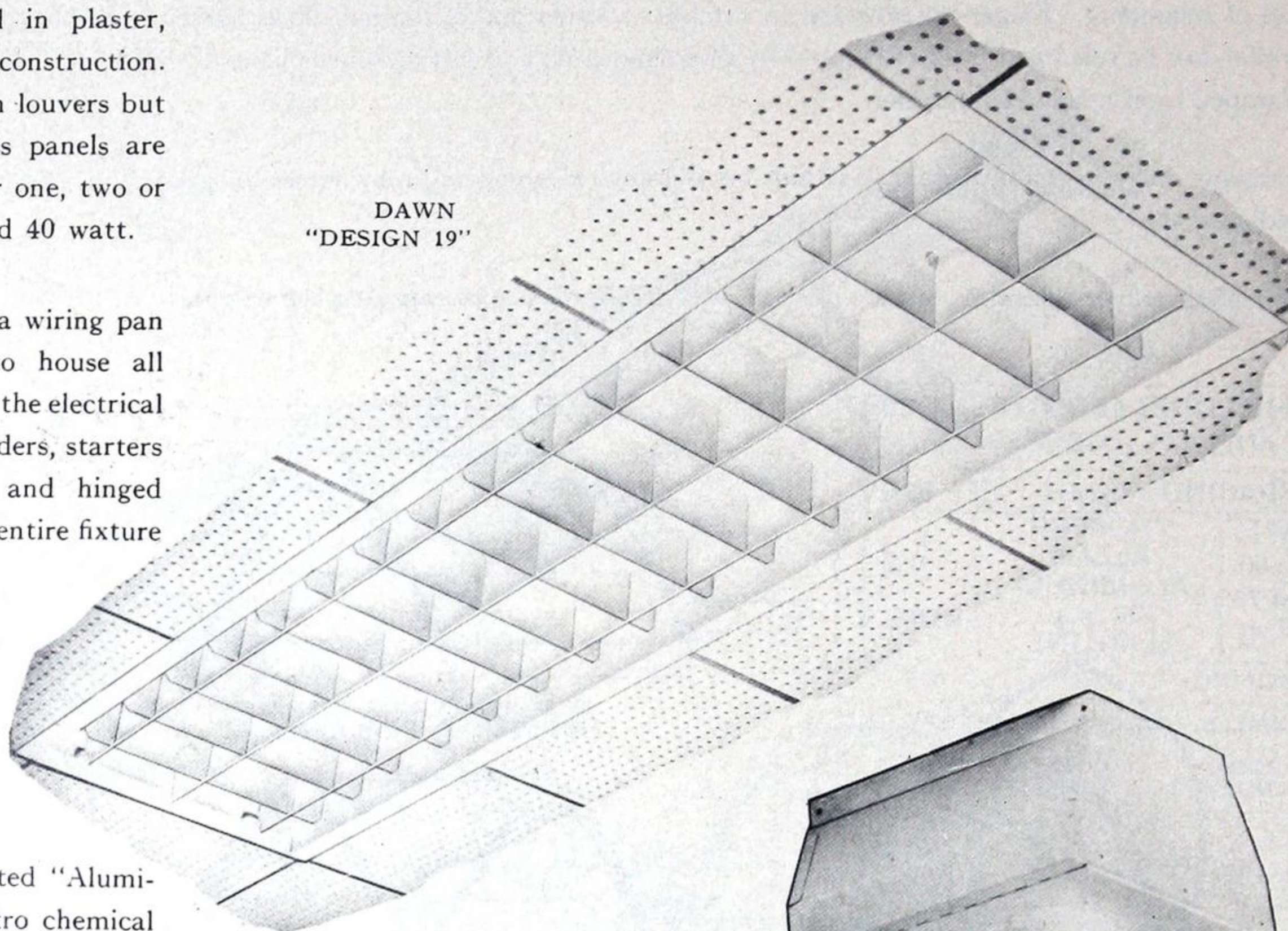

SPOTLIGHT-1R40-C-19

SHIELDING LENGTHWISE 25°		ANGLE CROSSWISE 35°				
SPACING 1.0xMH		EFF 57.0%				
M.F.	TROFFER 24019 LOUVERED	0% ↑				
G.70		57.0% ↓				
M.65						
P.60						
CEILING	75%	50%				
WALLS	50%	30%	10%	50%	30%	10%
ROOM INDEX	COEFFICIENT OF UTILISATION					
J	.31	.29	.26	.30	.29	.27
I	.37	.36	.35	.31	.35	.34
H	.40	.39	.38	.35	.39	.38
G	.43	.42	.41	.37	.41	.40
F	.45	.44	.42	.43	.43	.42
E	.48	.47	.45	.47	.46	.45
D	.51	.49	.47	.49	.48	.47
C	.52	.50	.48	.50	.49	.48
B	.53	.51	.50	.51	.50	.49
A	.54	.52	.51	.52	.51	.50

Catalogue No.*	Lamp Watts	Cycles	Dimensions		
			Length	Width	Height
14019	1 - 40	60	48"	11 3/4"	8"
22019	2 - 20	60	24"	11 3/4"	8"
24019**	2 - 40	60	48"	11 3/4"	8"
34019	3 - 40	60	48"	11 3/4"	8"

*Standard unit equipped with louver—available with diffusing glass panel if specified.
**For instant start operation add suffix "IS" to catalogue number.



RECESSED TROFFERS

Lighting Materials Aluminum Recessed Troffer

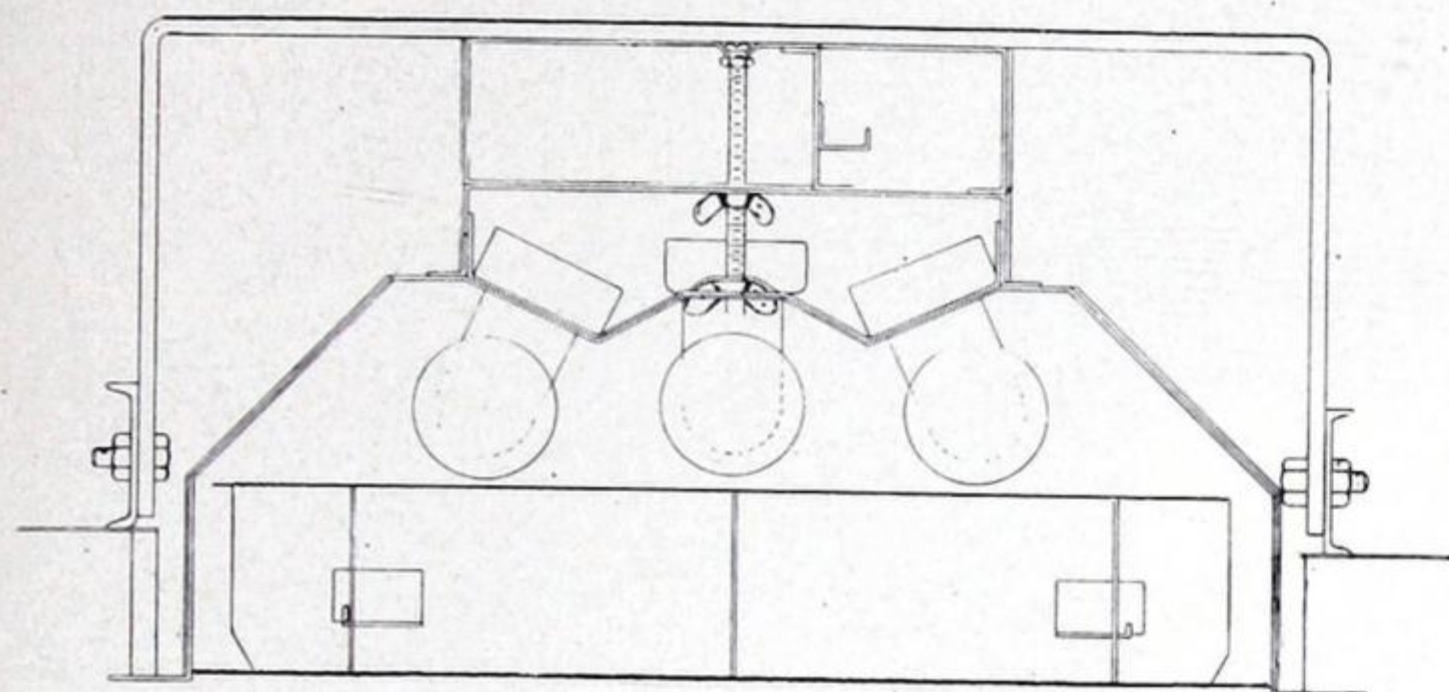

CROSS SECTION

CEILING OPENING REQUIRED: $48\frac{1}{8}$ " x 12". CLEARANCE REQUIRED ABOVE CEILING LINE: $7\frac{1}{4}$ ".

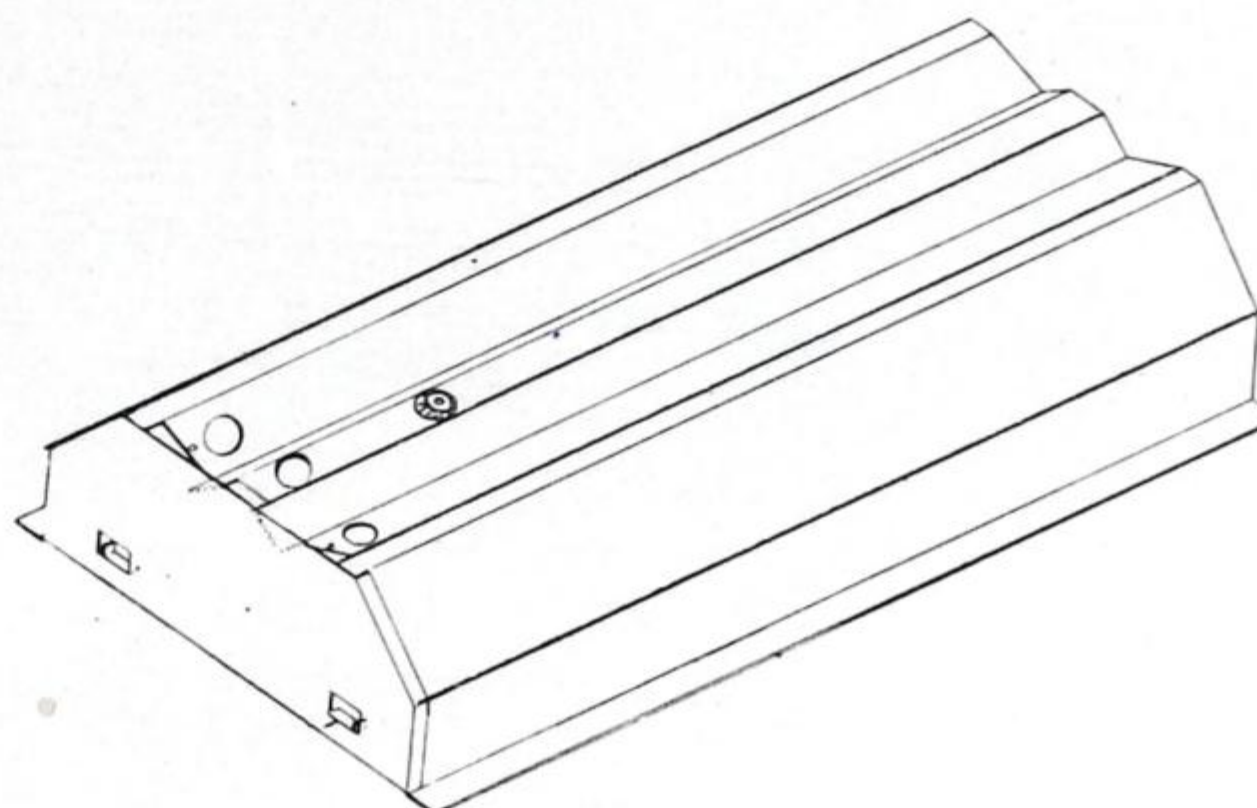

REFLECTOR—ONE-PIECE PAN WITH END CAPS WELDED ON. QUICKLY REMOVABLE BY TWO WING NUTS WITHOUT DISTURBING ELECTRICAL PAN.

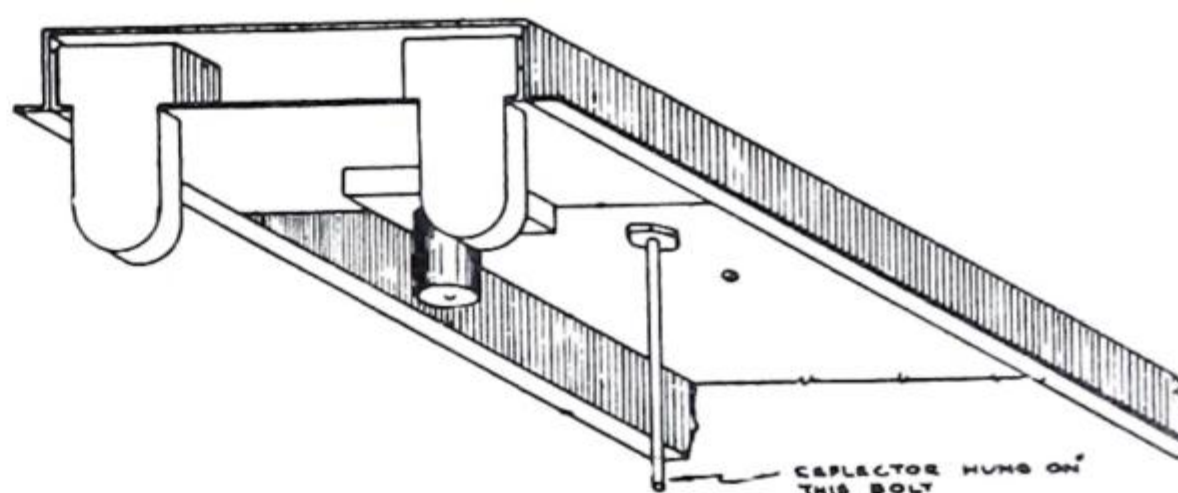
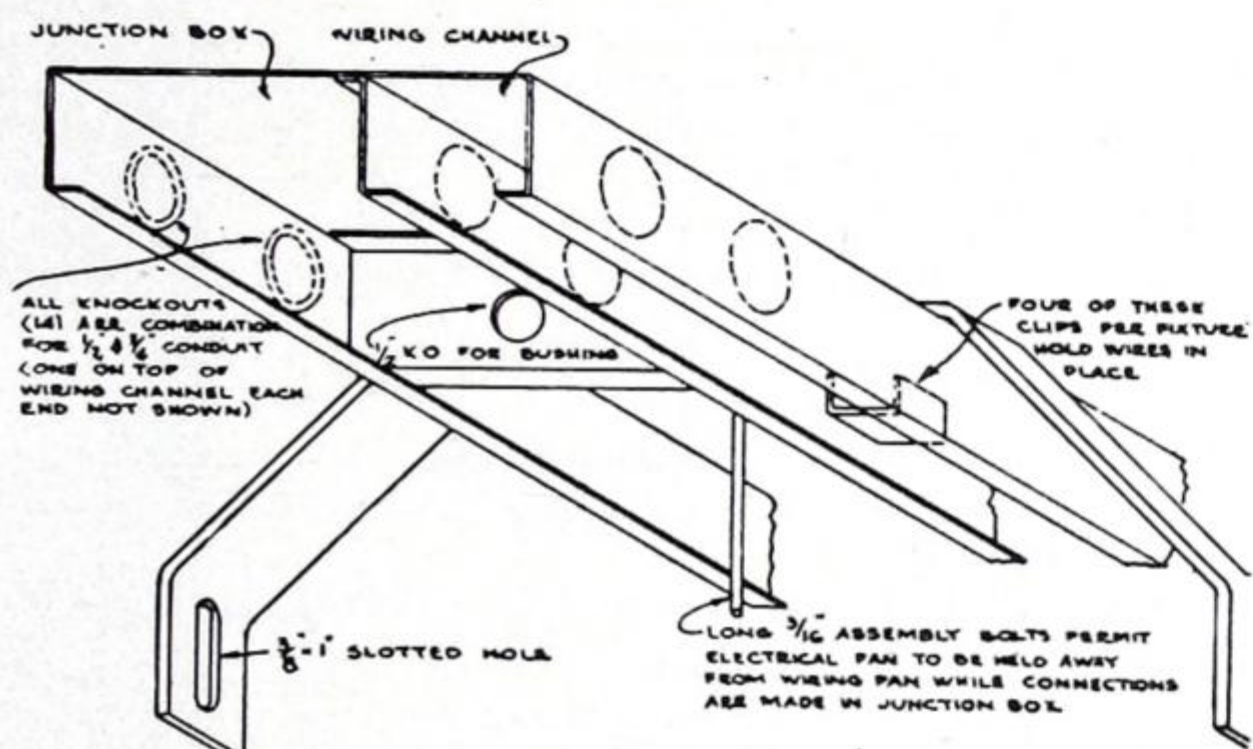

WIRING PAN—INSTALL THIS IN CEILING FIRST. LEVEL AND LINE UP. THEN RUN ALL CIRCUIT WIRING IN THE WIRING CHANNEL.

ELECTRICAL PAN—HOLDS BALLAST, LAMPHOLDERS AND STARTERS. INSTALLED AFTER WIRING PAN. REMOVABLE BY TWO WING NUTS WITHOUT DISTURBING MAIN WIRING.

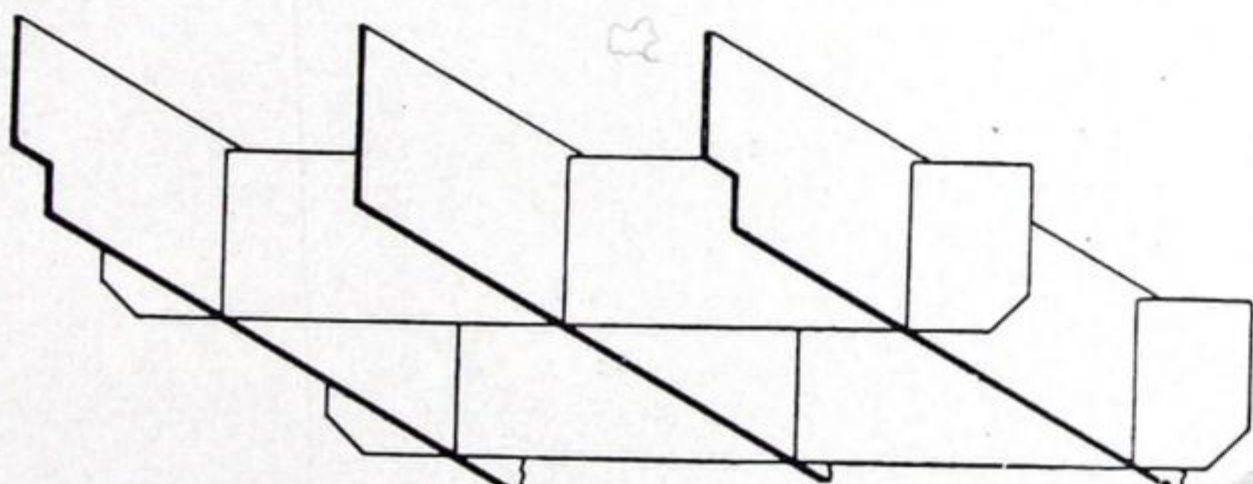

LOUVER—HINGES FROM EITHER SIDE. SHIELDING: 35° LATERAL, 25° LONGITUDINAL.

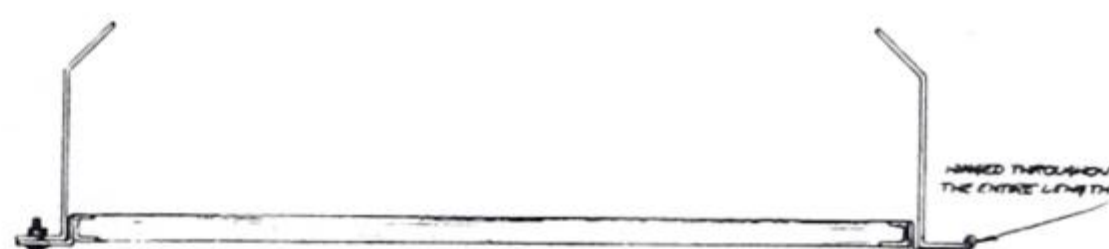

ALTERNATIVE GLASS PANEL BOTTOM.

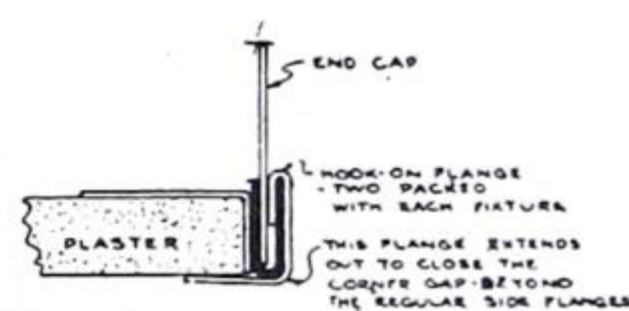
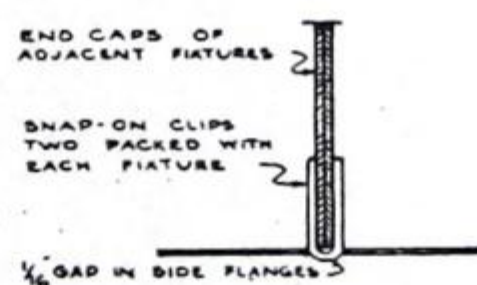

DETAIL AT JUNCTION OF FIXTURES IN A CONTINUOUS ROW. DETAIL AT EXTREME ENDS OF SINGLE UNITS OR CONTINUOUS ROWS.



RECESSED TROFFERS

Electrolier Recessed Toggle Troffers

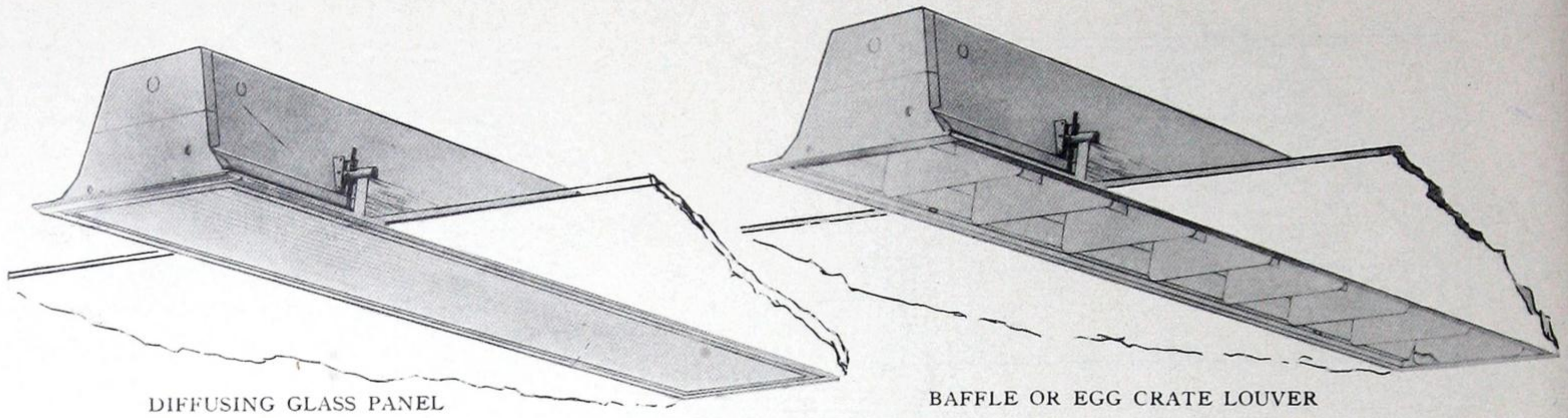

Electrolier Fluorescent Recessed Troffers are designed for easy installation and maintenance and engineered for high efficiency without glare. Suitable for single installation or in continuous rows.

Fixtures when equipped with egg crate or baffle louvers prevent glare in all normal viewing angles. They are particularly useful in preventing eye strain when looking down the length of a fixture or line of fixtures. The complete louver is hinged and can easily be removed when necessary. These troffers are also available with albalite diffusing glass panel in hinged frame.

A special feature of the Electrolier Troffer unit is the self-fastening toggle arrangement for easy installation. Four toggle supports are provided, two on each side of the unit. By raising the toggle in a vertical position the complete fixture can be slipped past the opening into position.

The toggle arrangement grips the upper part of the ceiling, providing safe and secure fastening of the fixture to the ceiling. This system is self-aligning, drawing up the fixture flush, at the same time adjusting itself to any irregularities in the ceiling. No extra parts are required, such as hangers, yokes, clamps, flanges, hooks, etc.

The inside wireway reflector is hinged, providing easy access for servicing and wiring. A simple pressure on two spring clips allows the reflector to swing down and if necessary can be removed from the housing.

Catalogue Number	Lamp Watts	Description	Dimensions		
			Box Size		Overall Depth
			Length	Width	
K902-48 K903-48	2 x 40 3 x 40	Open Type	48"	11 7/8"	8 3/4"
KE902-48 KE903-48	2 x 40 3 x 40	With Hinged Egg Crate Louver	48"	11 7/8"	8 3/4"
KL902-48 KL903-48	2 x 40 3 x 40	With Hinged Baffle Louver	48"	11 7/8"	8 3/4"
KG902-48 KG903-48	2 x 40 3 x 40	With Hinged Albalite Diffusing Panel	48"	11 7/8"	8 3/4"

SPACING .7xMH EFF 70.2%

M.F.	TROFFER	0% ↓
G.75	K902-48	
M.70		
P.65	OPEN TYPE	70.2% ↓

CEILING	75%	50%				
WALLS	50% 30% 10%	50% 30% 10%				
ROOM INDEX	COEFFICIENT OF UTILISATION					
J	.33	.30	.29	.32	.31	.29
I	.39	.37	.36	.38	.36	.36
H	.42	.41	.40	.41	.40	.39
G	.45	.44	.44	.44	.44	.42
F	.47	.46	.45	.45	.45	.44
E	.49	.49	.47	.49	.48	.47
D	.53	.51	.49	.51	.50	.49
C	.54	.52	.50	.52	.51	.50
B	.55	.53	.52	.54	.52	.51
A	.55	.54	.53	.54	.53	.52

SHIELDING LENGTHWISE 35° ANGLE CROSSWISE 45°

SPACING .70xMH EFF 56.1%

M.F.	TROFFER	0% ↓
G.70	KL902-48	
M.65	BAFFLE LOUVER	56.1% ↓
P.60		

CEILING	75%	50%				
WALLS	50% 30% 10%	50% 30% 10%				
ROOM INDEX	COEFFICIENT OF UTILISATION					
J	.32	.30	.29	.31	.30	.29
I	.38	.37	.36	.38	.36	.36
H	.41	.40	.40	.40	.40	.39
G	.44	.43	.43	.43	.42	.42
F	.46	.45	.44	.44	.44	.43
E	.48	.47	.46	.47	.46	.45
D	.51	.49	.48	.49	.48	.48
C	.52	.50	.49	.51	.49	.48
B	.52	.51	.51	.51	.50	.49
A	.53	.52	.51	.52	.51	.50

SPACING .75xMH EFF 52.5%

M.F.	TROFFER	0% ↓
G.75	KG902-48	
M.70	DIFFUSING GLASS	52.5% ↓
P.65		

CEILING	75%	50%				
WALLS	50% 30% 10%	50% 30% 10%				
ROOM INDEX	COEFFICIENT OF UTILISATION					
J	.22	.20	.19	.22	.20	.19
I	.27	.25	.24	.26	.25	.24
H	.29	.28	.27	.28	.27	.26
G	.31	.30	.29	.31	.29	.28
F	.33	.32	.30	.31	.31	.30
E	.34	.34	.32	.34	.33	.32
D	.37	.35	.34	.36	.35	.34
C	.38	.36	.35	.37	.36	.36
B	.39	.37	.37	.38	.36	.36
A	.39	.38	.37	.39	.37	.36

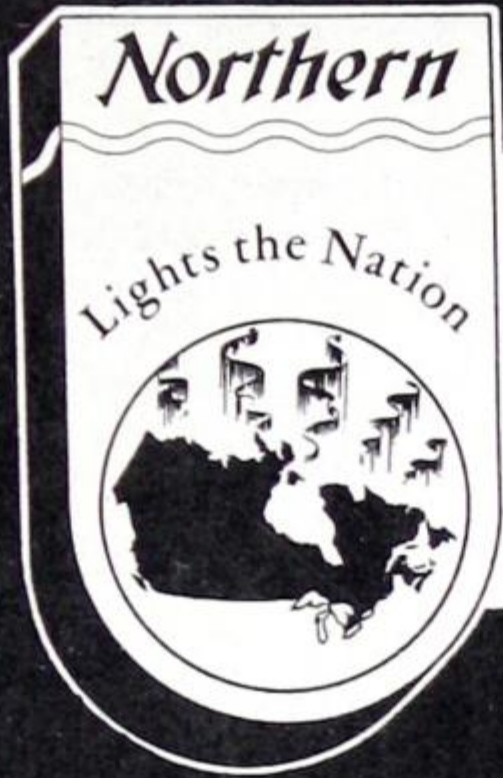
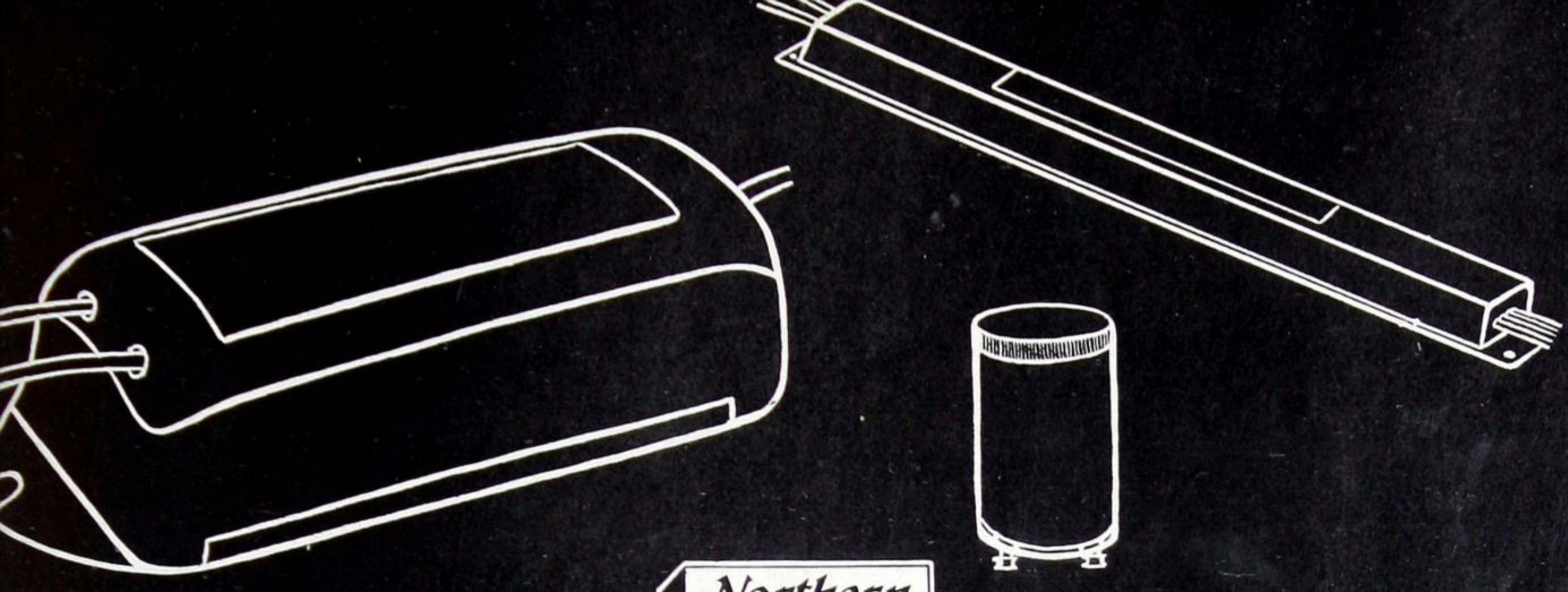

FLUORESCENT ACCESSORIES

CONTENTS

Starters	178
Lampholders and Starter Sockets—Standard Fluorescent Lamps	179
Lampholders—Slimline Lamps	179
Fluorescent and Slimline Ballasts	180
Radio Interference Suppressors	183
Ballast Wiring Diagrams	183



Use the

Northern Electric Lighting Service



Starters

In order to obtain the rated life from ordinary hot-cathode fluorescent lamps, it is necessary that the cathodes be preheated to the point where they are emitting electrons at a rate sufficient to support the arc before the arc is struck. This then means two steps in starting, first, to preheat the cathodes, and, second, to apply sufficient voltage to break down the gas column.

The starting mechanism, which serves to close the circuit for preheating the cathodes and to open this circuit for starting the lamp, is directly across the lamp from one cathode to the other. Any voltage surge which appears across this switch is then likely to appear across the lamp also. In this manner cathodes are preheated and the high voltage applied for starting the lamp when the starting mechanism is opened at the end of the preheat period.

The device which automatically accomplishes this preheating of the cathodes and subsequent starting of the lamp is generally referred to as a starting switch or starter. Two varieties are available in the current market, one known as the glow switch starter (2 pins) and the other as the thermal starter (4 pins). In each case a thermostatic switch of bimetal performs the function of closing and opening the starting circuit. A condenser is then connected across this switch, primarily for the purpose of suppressing radio interference. The glow switch starter has become standard for most applications.

In the glow switch starter, the switch mechanism consists of two electrodes, one of bimetal, mounted in a glass envelope which contains gas at a definite low pressure. There is no contact between the two electrodes. With the starter switch in place, when the supply circuit is closed the gas in the envelope breaks down and a glow appears around the electrodes. The energy in this glow produces enough heat to cause the bimetal electrode to change shape to the point where it touches the other electrode. This makes a metallic contact and circuit through the switch with the result that the glow ceases and the preheating current flows through the cathodes. If the starter is properly designed and built, this circuit will be maintained the desired time duration before the bimetal cools to the point of breaking its contact with the other electrode. When the contact is broken a voltage surge may result and the lamp light, but if this is not accomplished the first time the cycle should repeat itself automatically until the lamp is lighted. Once the arc is struck and the lamp lights, the voltage across the lamp is reduced to the point where the glow in the switch ceases and the starter circuit remains open and inactive.

Certain starters are now available in which an added mechanism has been incorporated and which is intended to function only when a lamp reaches the end of its useful life. These starters are so arranged that when a lamp fails to start within a reasonable period of time this added mechanism functions to disconnect this lamp from its circuit. This serves two purposes, first, to stop the blinking of the lamp in trying to start and operate, which is a condition of physical discomfort for those nearby, and, second, to protect the ballast from excessive heating due to continuous operation under lamp starting conditions. These starters are available in two types, automatic or manual reset.

These descriptions are brief and do not go into the details of construction or of operation of the starters. They do serve, however, to indicate that the starter is an element which needs careful adjustment and control in manufacture and, as such, should receive equal care in handling and in use. As furnished, the starter is mounted in a metal or plastic container (can or shell) and has two (or four) contact members protruding from an insulating cap at one end. The assembly is sturdy yet cannot be expected to withstand all kinds of rough handling. Since many of the starters contain a glass part they must be treated as breakable.

Not only may parts be broken by rough handling, but the small moving elements may be thrown out of alignment due to severe shock or by a sudden blow.



GLOW TYPE FIG. 1



GLOW TYPE FIG. 2



GLOW TYPE FIG. 3



THERMAL TYPE FIG. 4

Lamp Watts	Standard (Fig. 1)	Automatic Reset (Fig. 2)	Manual Reset (Fig. 3)
14, 15 20, 22	FS-2	FS-20-FA	FS-20
25	FS-25	—	—
13, 30 40	FS-4 FS-4DC*	—	—
30	—	—	FS-30
32	FS-12	FS-120	—
40	FS-44†	FS-40-FA	FS-40
85	FS-6 FS-64†	FS-185**	FS-850**

*Direct Current only.

†Thermal type Starters—4 terminals (Fig. 4) for low temperature operation of 40W lamp.

**FS-185 Glow type—Specify 2 or 4 terminals.

**FS-850 Glow type—4 terminals only.



Lampholders and Starter Sockets

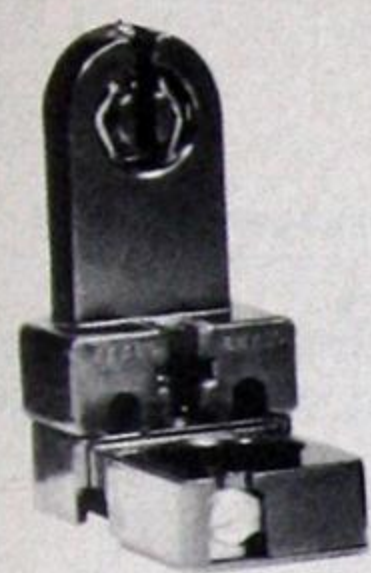

78 x 729 (BLACK)
78 x 736 (WHITE)

STANDARD TYPE



78 x 354 (BLACK)
78 x 491 (WHITE)



95 x 168 (WHITE)
95 x 311 (BLACK)

CAM-LOC TYPE



1050 (BLACK)
1050W (WHITE)

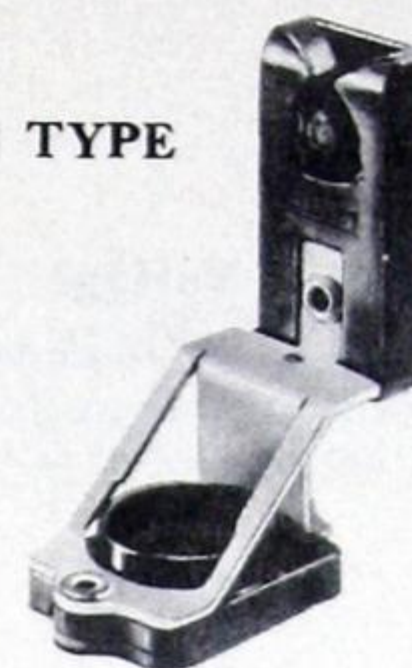

1053

FLEX-LOC TYPE



C653 (BLACK)
C653W (WHITE)



C651 (BLACK)
C651W (WHITE)



356 (BLACK)
356W (WHITE)

TURRET TYPE

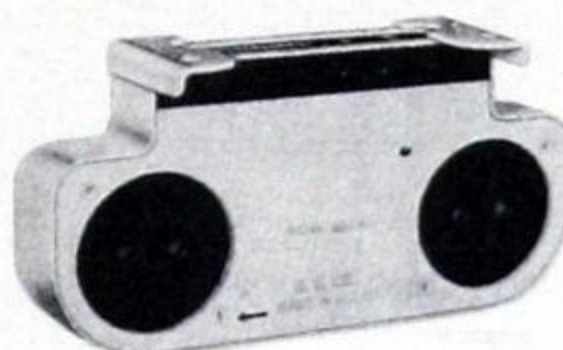

95 x 498 (3 1/2" CENTERS)
95 x 934 (5" CENTERS)



95 x 935 (2 STARTER SOCKETS)
95 x 936 (1 STARTER SOCKET)

STANDARD TYPE

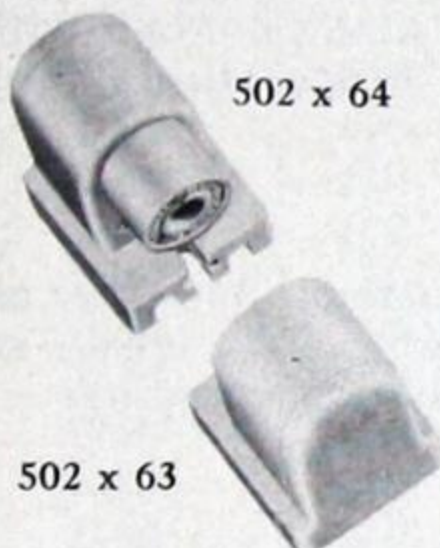

502 x 64

502 x 63

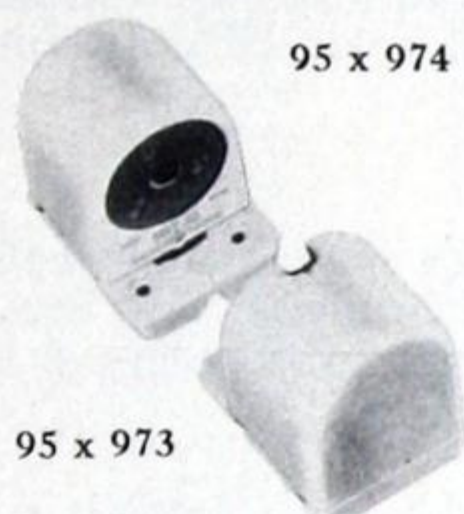

95 x 974

95 x 973

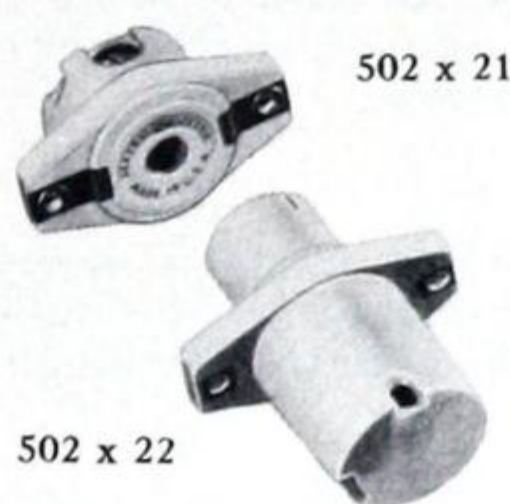

502 x 21

502 x 22

TURRET TYPE

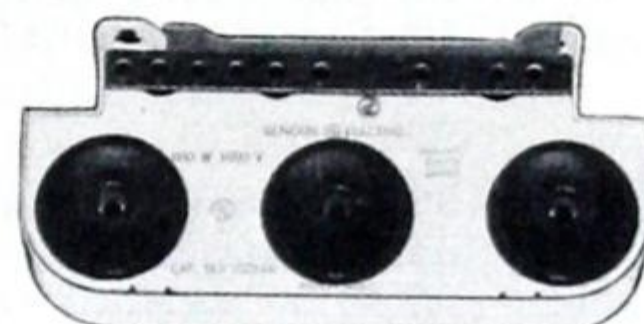

502 x 47 502 x 48

CAM-LOC TYPE

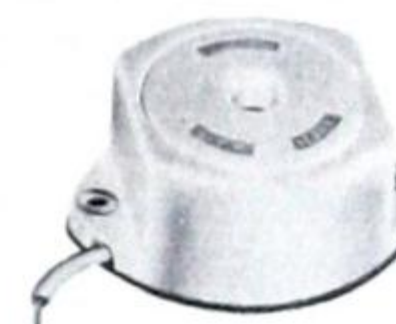

950H

Catalogue No.	Lampholders
78x729	Standard Medium Lampholder & Starter Socket for T-8 and T-12 Lamps, Black
78x736	Standard Medium Lampholder & Starter Socket for T-8 and T-12 Lamps, White
78x354	Standard Medium Lampholder only, for T-8 and T-12 Lamps, Black
78x491	Standard Medium Lampholder only, for T-8 and T-12 Lamps, White
95x168	Butt-On Medium Lampholder for T-8 and T-12 Lamps, White
95x311	Butt-On Medium Lampholder for T-8 and T-12 Lamps, Black
95x102	Standard Mogul Lampholder for T-17 Lamps, White
95x123	Standard Mogul Lampholder & 4 Terminal Starter Socket for T-17 Lamps, White
95x267	Butt-On Mogul Lampholder for T-17 Lamps, Tapped
95x273	Butt-On Mogul Lampholder for T-17 Lamps, Eyelets
1050*	Cam-Loc Lampholder with right angular mounting bracket, Black
1051*	Cam-Loc Lampholder with plain eyelet for mounting against end plate
1052*	Cam-Loc Lampholder with threaded bushing for mounting against end plate
1053	Cam-Loc Lampholder & Starter Socket for T-8 and T-12 Lamps, Black
C-651*	Flex-Loc Lampholder, Black
C-653*	Flex-Loc Lampholder & Starter Socket, Black
356*	Flex-Loc Lampholder & Starter Socket behind, Black
95x498	Twin Turret Lampholder, 3 1/2" centers
95x934	Twin Turret Lampholder, 5" centers
95x935	Triple Turret Lampholder, 2 Starter Sockets
95x936	Triple Turret Lampholder, 1 Starter Socket
502x6	Slimline Twin Turret high voltage end. Companion low voltage end—502x7
502x48	Slimline Triple Turret high voltage end. Companion low voltage end—502x47
95x974	Slimline Lampholder high voltage end. Companion low voltage end—95x973
502x64	Slimline Lampholder high voltage end. Companion low voltage end—502x63
502x22	Slimline Lampholder high voltage end. Companion low voltage end—502x21
95x976†	Slimline Lampholder high voltage end. Companion low voltage end—95x975
950H*	Slimline Cam-Loc Lampholder high voltage end. Companion low voltage end—950L*

*Suffix W to Catalogue number for white.
†For T-6 and T-8 lamps only, remainder of slimline lampholders for T-6, T-8, or T-12 lamps.



950L

TYPICAL CAM-LOC OPERATION

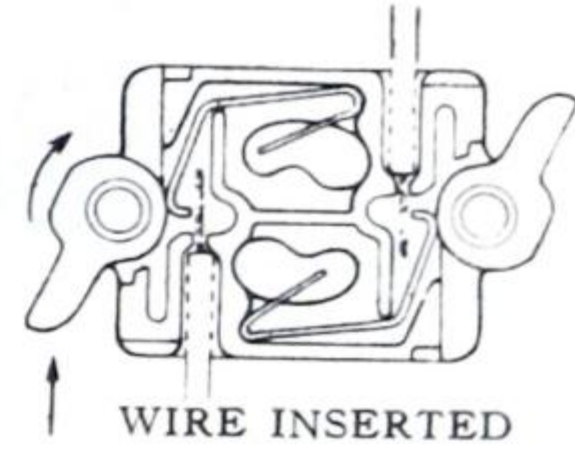

WIRE INSERTED

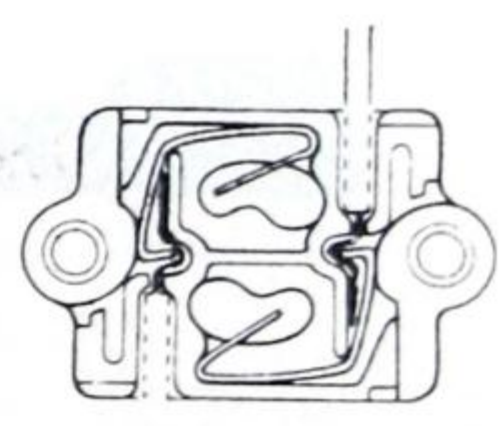

WIRE LOCKED

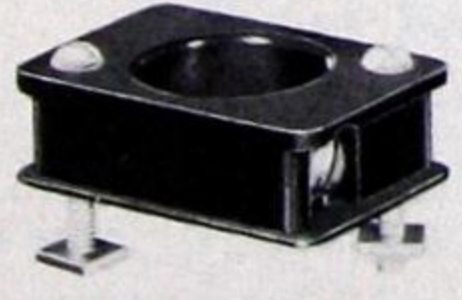

78 x 769 STANDARD STARTER SOCKET

Catalogue No.	Separate Starter Sockets
78x769	Socket for FS-5, FS-2, FS-20, FS-4, FS-4DC, FS-30, FS-12, FS-40 Starters.
95x180	Socket for FS-44, FS-64, FS-100, FS-6 Starters
450	Cam-Loc socket for 2-terminal starters
452	Cam-Loc socket for 2-terminal starters with 6" wire leads attached



450 CAM-LOC STARTER SOCKET



BALLASTS

Ballast Operation

Impressed Voltage

All ballasts are designed to deliver rated watts to the lamp at the nominal voltage stamped on the ballast. Deviation from these values will cause the lamp to deliver other than its rated output, and under certain conditions may damage the ballast. It is recommended that the impressed potential be maintained within the following limits:

Nominal Voltage	Lowest Permissible Voltage	Highest Permissible Voltage
118	110	125
208	199	216
236	220	250
260	240	280
265	250	280

Frequency

The frequency of the circuit to which the ballast is connected must be that which is specified on the ballast.

Ventilation

Ballasts, like other electrical equipment, generate heat during normal operation. To prevent damage to the ballast and the fixture, as well as to maintain proper light output from the lamps, the fixture and the installation should be designed to keep operating temperatures as low as possible. It is recommended that ballasts be mounted with as much as possible of their surfaces in direct contact with the metal portions of the fixtures which are themselves in direct contact with the surrounding air. The maximum temperature of any spot on a ballast case should not exceed 90° C during normal operation.

Noise

While all ballasts produce some noise, the average noise levels vary from model to model. Since the total noticeable noise produced by an installation depends on fixture design, ballast mounting, resonant qualities of the walls and furniture, and the ambient noise level—as well as the ballast design—these factors should be carefully considered in fixture design and the early stages of installation planning.

Moisture

Ballasts should be protected from weather, moisture, or other abnormal atmospheric conditions by special fixtures designed to meet special conditions.

Radio Interference

Radio interference may be caused by radio frequencies generated by fluorescent lamps. A reactor-capacitor-type filter is recommended for its suppression.

Types of Ballast Cases



A-STANDARD CASE

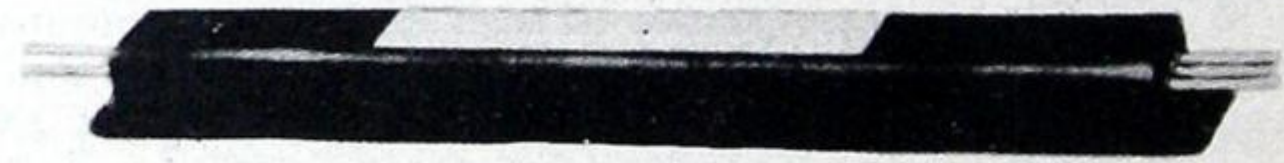

B



C



D

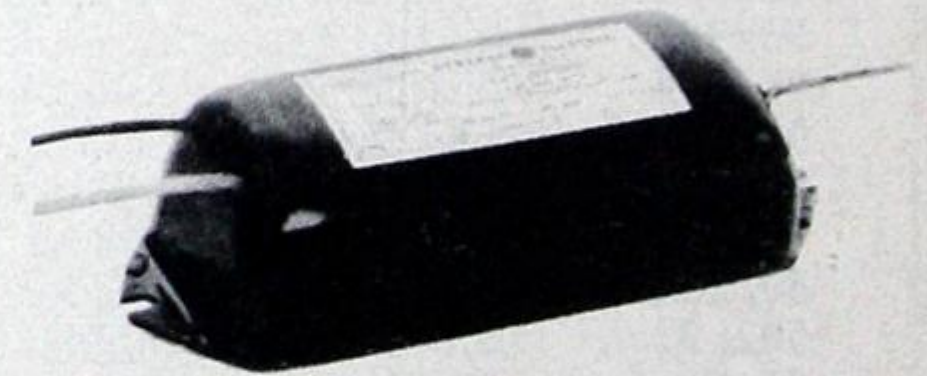

E

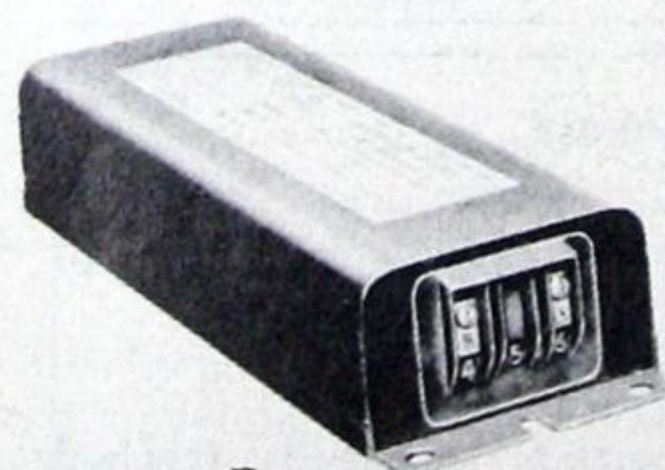

F

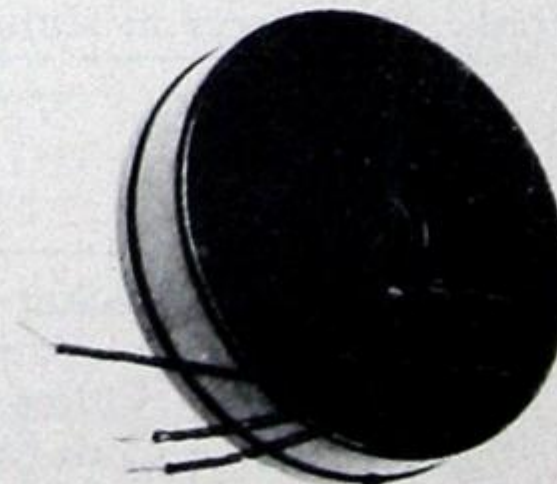

G



BALLASTS

60-Cycle Ballasts for General Line Fluorescent Lamps

For Fluorescent Lamps with Miniature Bipin Bases and Circuits using Starters

Lamp Watts	Circuit Voltage	Cat. No.	Approx. Size Inches	Wt. ea. lbs.	Approx. Watts Loss	Approx. Power Factor	Line Current, Amps.	Diagram No.	Case Type
1-4	110-125	58G848	1 1/4 x 1 3/4 x 4 1/4	3/4	1.75	45	0.11	1	D
1-6	110-125	58G818	1 1/4 x 1 3/4 x 4 1/4	3/4	2	45	0.16	1	D
1-8	110-125	58G649	1 1/4 x 1 3/4 x 4 1/4	3/4	2.8	45	0.175	1	D
1-13	110-125	89G413	1 5/8 x 2 3/8 x 6 1/2	2 1/2	5	45	0.35	3	E
1-13	110-125	89G414	1 5/8 x 2 3/8 x 10	3 1/2	5	90*	0.175	3	E

For Fluorescent Lamps with Medium Bipin Bases and Circuits using Starters

1-14	110-125	58G862	1 1/4 x 1 3/4 x 4 1/4	3/4	4.5	45	0.395	1	D
1-14	110-125	58G864	1 3/8 x 2 1/4 x 8 3/4	1 1/2	3.6	85*	0.20	3	C
2-14	110-125	58G914	1 1/4 x 1 3/4 x 6 1/2	1 1/2	7.2	44	0.79	4	D
3-14	110-125	59G352	1 3/8 x 2 1/4 x 8 3/4	2 1/2	13.5	45	1.20	6	C
1-15	110-125	58G670	1 1/4 x 1 3/4 x 4 1/4	3/4	4.5	55	0.30	1	D
1-15	110-125	58G640	1 3/8 x 2 1/4 x 8 3/4	1 3/4	4.5	90*	0.19	3	C
2-15	110-125	58G691	1 1/4 x 1 3/4 x 6 1/2	1 1/2	9	55	0.60	4	D
2-15	110-125	58G678	1 3/8 x 2 1/4 x 14 1/4	3 1/4	9	90*	0.35	5	C
3-15	110-125	59G369	1 3/8 x 2 1/4 x 8 3/4	2 1/2	13.5	55	0.99	6	C
1-20	110-125	58G671	1 1/4 x 1 3/4 x 4 1/4	3/4	4.5	55	0.35	1	D
1-20	110-125	58G641	1 3/8 x 2 1/4 x 8 3/4	1 3/4	4.5	90*	0.23	3	C
2-20	110-125	58G692	1 1/4 x 1 3/4 x 6 1/2	1 1/2	9	55	0.70	4	D
2-20	110-125	58G679	1 3/8 x 2 1/4 x 14 1/4	3 1/4	9	90*	0.45	5	C
3-20	110-125	59G347	1 3/8 x 2 1/4 x 8 3/4	2 1/2	13.5	55	1.05	6	C
1-25	110-125	59G908	1 1/4 x 1 3/4 x 6 1/2	1 3/8	10	50	0.52	1	D
2-25	110-125	59G909	1 3/8 x 2 1/4 x 8 3/4	2 7/8	17	50	1.05	4	C
3-25	110-125	59G910	1 3/8 x 2 1/4 x 14 1/4	4 3/8	26	50	1.60	6	C
1-30	110-125	89G304	1 5/8 x 2 3/8 x 6 1/2	2 1/2	8.5	50	0.65	3	E
1-30	110-125	89G344	1 5/8 x 2 3/8 x 10	3 3/4	10.5	90*	0.35	3	E
2-30	110-125	58G980	2 3/8 x 3 1/8 x 9 1/2	7	12.5	90*	0.70	7	A
2-30	110-125	58G940	1 3/8 x 2 1/4 x 18 1/4	6	16	90*	0.70	7	B
1-40 ³	110-125	89G307	1 5/8 x 2 3/8 x 6 1/2	2 1/2	8.5	50	0.80	3	E
1-40 ³	110-125	89G347	1 5/8 x 2 3/8 x 10	3 3/4	11	90*	0.45	3	E
2-40 ³	110-125	58G983	2 3/8 x 3 1/8 x 9 1/2	7	15.5	90*	0.85	7	A
2-40 ³	220-250	58G985	2 3/8 x 3 1/8 x 9 1/2	7	12.5	90*	0.43	7	A
2-40 ³	110-125	89G343	1 5/8 x 2 3/8 x 16 1/8	6 1/2	18.5	90*	0.85	7	E
3-40 ³	110-125	59G276	2 3/8 x 3 1/8 x 14 3/8	11	23	90*	1.30	8	A

Trigger Start Ballasts—Using Standard Lamps but no Starters

1-14, 15 or 20	110-125	89G320	1 5/8 x 2 3/8 x 6 1/2	2 3/4	12 ⁹	..	0.82 ⁹	9	E
2-20	110-125	89G321		2 3/8	12	..	0.90	10	E

For Fluorescent Lamps with Mogul Bipin Bases and Circuits using Starters

1-85	110-125	58G628	2 3/8 x 3 1/8 x 14 3/8	10 1/4	25	90*	1.20	11	A
2-85	110-125	58G696	2 3/8 x 3 1/8 x 19 1/4	14 1/2	32	90*	1.90	12	A

For Instant Start Fluorescent Lamps—No Starters Required¹

1-40	110-125	59G972 ¹	2 3/8 x 3 1/8 x 14 3/8	10 1/2	15	90*	0.50	13 ²	A
2-40	110-125	59G373 ¹	2 3/8 x 3 1/8 x 14 3/8	11	28	90*	0.98	14	A
2-40	110-125	89G400 ⁴	2 3/8 x 3 1/8 x 11 3/4	8 1/4	22	90*	0.95	17	A

60-Cycle Ballasts for Circline Fluorescent Lamps

Lamp Watts	Circuit Voltage	Cat. No.	Approx. Size Inches	Wt. ea. lbs.	Approx. Watts Loss	Approx. Power Factor	Line Current, Amps.	Diagram No.	Case Type
1-32	110-125	89G300	1 5/8 x 2 3/8 x 6 1/2	2 1/2	8.5	50	0.60	18	E
1-32	110-125	59G420	1 3/8 x 6 Dia.	4	8.5	50	0.67	18	G
1-32	110-125	89G332 ⁷	1 5/8 x 2 3/8 x 6 1/2	2 3/4	14	..	1.00	9	E
1-32	110-125	59G425	1 3/8 x 8 Dia.	6	8	90*	0.38	18	G

25-Cycle Ballasts for General Line Fluorescent Lamps

For Fluorescent Lamps with Medium Bipin Bases and Circuits using Starters

Lamp Watts	Circuit Voltage	Cat. No.	Approx. Size Inches	Wt. ea. lbs.	Approx. Watts Loss	Approx. Power Factor	Line Current, Amps.	Diagram No.	Case Type
1-15	110-125	17A5	1 3/8 x 2 1/4 x 8 3/4	2 1/2	7	60	0.32	1	C
1-20	110-125	17A6	1 3/8 x 2 1/4 x 8 3/4	2 1/2	8	55	0.37	1	C
1-30	110-125	17A7 ¹⁰	1 3/8 x 2 1/4 x 8 3/4	2 1/2	9	50	0.65	2	C

Dual Frequency 25/60 Cycle Ballast for General Line Fluorescent Lamps

For Fluorescent Lamps with Medium Bipin Bases and Circuits using Starters

Lamp Watts	Circuit Voltage	Cat. No.	Approx. Size Inches	Wt. ea. lbs.	Approx. Watts Loss	Approx. Power Factor	Line Current, Amps.	Diagram No.	Case Type
2-40	110-125	17A8	2 5/8 x 3 1/8 x 19 1/4	16	{60cy. 15.5 25cy. 24.0	90	{60cy. 0.85 25cy. 0.90	7	A



BALLASTS

60-Cycle Ballasts for Slimline Fluorescent Lamps

No Starters Required. Ballasts have Type A Standard Cases. 110-125 Volts.

Lamp Size	Lamp Watts	Lamp Current ma.	Cat. No.	Approx. Size, Inches	Wt. ea. lbs.	Approx. Watts Loss	Approx. Power Factor	Line Current, Amps.	Diagram No.
42T6	1-18	120	59G740	$2\frac{3}{8} \times 3\frac{1}{8} \times 9\frac{1}{2}$	6	9	90*	0.33	13
	2-18		59G741	$2\frac{3}{8} \times 3\frac{1}{8} \times 11\frac{3}{4}$	$7\frac{1}{2}$	15	90*	0.48	15
	1-25	200	59G742	$2\frac{3}{8} \times 3\frac{1}{8} \times 9\frac{1}{2}$	$6\frac{3}{4}$	13	90*	0.42	13
	2-25		59G743	$2\frac{3}{8} \times 3\frac{1}{8} \times 11\frac{3}{4}$	9	21	90*	0.65	15
	1-32	300	59G744	$2\frac{3}{8} \times 3\frac{1}{8} \times 9\frac{1}{2}$	$7\frac{1}{2}$	19	90*	0.48	13
	2-32		59G745	$2\frac{3}{8} \times 3\frac{1}{8} \times 14\frac{3}{8}$	$11\frac{1}{2}$	32	90*	1.00	15
48T12	1-36	430	59G972 ¹	$2\frac{3}{8} \times 3\frac{1}{8} \times 14\frac{3}{8}$	$10\frac{1}{2}$	15	90*	0.50	13
	2-36		59G373 ¹	$2\frac{3}{8} \times 3\frac{1}{8} \times 14\frac{3}{8}$	11	28	90*	0.98	14
	2-36		89G400 ⁴	$2\frac{3}{8} \times 3\frac{1}{8} \times 11\frac{3}{4}$	$8\frac{1}{4}$	22	90*	0.95	17
64T6	1-26	120	59G770	$2\frac{3}{8} \times 3\frac{1}{8} \times 9\frac{1}{2}$	$6\frac{1}{2}$	11	90*	0.38	13
	2-26		59G771	$2\frac{3}{8} \times 3\frac{1}{8} \times 11\frac{3}{4}$	9	22	90*	0.70	15
	1-37	200	59G772	$2\frac{3}{8} \times 3\frac{1}{8} \times 11\frac{3}{4}$	$7\frac{3}{4}$	17	90*	0.54	13
	2-37		59G773	$2\frac{3}{8} \times 3\frac{1}{8} \times 14\frac{3}{8}$	$11\frac{1}{2}$	31	90*	0.90	15
	2-37		59G781 ⁵	$2\frac{3}{8} \times 3\frac{1}{4} \times 13$	14	25	90*	1.00	16
	1-48	300	59G774	$2\frac{3}{8} \times 3\frac{1}{8} \times 11\frac{3}{4}$	9	21	90*	0.78	13
2-48	59G775		$2\frac{3}{8} \times 3\frac{1}{8} \times 19\frac{1}{4}$	$14\frac{1}{4}$	37	90*	1.25	15	
2-48	59G779 ⁵		$2\frac{3}{8} \times 4\frac{3}{8} \times 13$	14	30	90*	1.25	16	
72T8	1-25	120	59G770	$2\frac{3}{8} \times 3\frac{1}{8} \times 9\frac{1}{2}$	$6\frac{1}{2}$	11	90*	0.38	13
	2-25		59G771	$2\frac{3}{8} \times 3\frac{1}{8} \times 11\frac{3}{4}$	9	22	90*	0.70	15
	1-36.5	200	59G772	$2\frac{3}{8} \times 3\frac{1}{8} \times 11\frac{3}{4}$	$7\frac{3}{4}$	17	90*	0.54	13
	2-36.5		59G773	$2\frac{3}{4} \times 3\frac{1}{8} \times 14\frac{3}{8}$	$11\frac{1}{2}$	31	90*	0.90	15
	2-36.5		59G781 ⁵	$2\frac{3}{8} \times 3\frac{1}{4} \times 13$	14	25	90*	1.00	16
	1-48.5	300	59G774	$2\frac{3}{8} \times 3\frac{1}{8} \times 11\frac{3}{4}$	9	21	90*	0.78	13
2-48.5	59G775		$2\frac{3}{8} \times 3\frac{1}{8} \times 19\frac{1}{4}$	$14\frac{1}{4}$	37	90*	1.25	15	
2-48.5	59G779 ⁵		$2\frac{3}{8} \times 4\frac{3}{8} \times 13$	14	30	90*	1.25	16	
72T12	1-54	430	59G948	$2\frac{5}{8} \times 3\frac{1}{8} \times 14\frac{3}{8}$	10	22	90*	0.75	13
	2-54		59G949	$2\frac{5}{8} \times 3\frac{1}{8} \times 19\frac{1}{4}$	15	33	90*	1.40	15
	2-54		59G947 ⁵	$2\frac{3}{8} \times 4\frac{3}{8} \times 14\frac{5}{8}$	$16\frac{3}{4}$	33	90*	1.40	16
	2-54		89G396 ⁴	$2\frac{5}{8} \times 3\frac{1}{8} \times 14\frac{3}{8}$	$13\frac{1}{2}$	32	90*	1.65	17
96T8	1-32.5	120	59G790	$2\frac{3}{8} \times 3\frac{1}{8} \times 9\frac{1}{2}$	7	14	90*	0.47	13
	2-32.5		59G791	$2\frac{3}{8} \times 3\frac{1}{8} \times 14\frac{3}{8}$	$10\frac{1}{2}$	31	90*	0.92	15
	1-49	200	59G792	$2\frac{3}{8} \times 3\frac{1}{8} \times 11\frac{3}{4}$	$8\frac{3}{4}$	20	90*	0.67	13
	2-49		59G793	$2\frac{3}{8} \times 3\frac{1}{8} \times 14\frac{3}{8}$	$11\frac{3}{4}$	32	90*	1.30	15
	2-49		59G798 ⁵	$2\frac{3}{8} \times 4\frac{3}{8} \times 13$	14	28	90*	1.20	16
	1-66	300	59G794	$2\frac{3}{8} \times 3\frac{1}{8} \times 14\frac{3}{8}$	11	25	90*	0.83	13
2-66	59G795		$2\frac{3}{8} \times 3\frac{1}{8} \times 19\frac{1}{4}$	$17\frac{1}{4}$	46	90*	1.60	15	
2-66	59G799 ⁵		$2\frac{3}{8} \times 4\frac{3}{8} \times 14\frac{5}{8}$	$16\frac{3}{4}$	36	90*	1.60	16	
96T12	1-72	430	59G964	$2\frac{5}{8} \times 3\frac{1}{8} \times 14\frac{3}{8}$	12	25	90*	0.90	13
	2-72		59G464	$2\frac{5}{8} \times 3\frac{1}{8} \times 19\frac{1}{4}$	18	40	90*	1.75	16
	2-72		59G458 ⁵	$2\frac{3}{8} \times 4\frac{3}{8} \times 17\frac{3}{8}$	16	40	90*	1.75	16
	2-72		89G396 ⁴	$2\frac{5}{8} \times 3\frac{1}{8} \times 14\frac{3}{8}$	$13\frac{1}{2}$	32	90*	1.65	17

NOTES

*High power factor ballasts.

¹For 48 inch T-12 or 60 inch T-17 40 watt lamps.

²Except that standard lampholders are used.

³40watt ballasts for circuit voltages of 199-216 volts, 220-250 volts and 240-280 volts are available.

⁴'Series type' ballast.

⁵Terminal boards instead of wire leads. Type F cases.

⁶B = Brass terminal on starter socket. Where combination lamp-holder and starter socket assemblies are used, the dotted con-

nections are already made internally (Diagrams 11 and 12).

⁷Trigger start. Fixture should have at least two metal contacts with lamp.

⁸The primary circuit is opened when either lamp is removed. This is accomplished by ordinary lampholders since lamp pins are shorted inside the base shell.

⁹Applies to 20-watt operation.

¹⁰Two ballasts are required for operation of each lamp.



Equipment for Suppression of Radio Interference

Radio interference from fluorescent lamps is caused by (1) direct radiation from the bulb, (2) direct radiation from the fluorescent power supply lines to the aerial and (3) line feedback from the lamp through the power circuit to the radio. The direct bulb radiation produces negligible interference if the aerial is at least 9 feet from the lamp and disturbance from line radiation and feedback can be minimized by the proper application of line filters at each lamp or fixture.

A simple form of filter is the 3-section capacitor, Catalogue No. 25F214 which is applicable for permanently wired and grounded fixtures and one such filter per fixture (or for each 8 feet of lamps in a cove) will reduce line noise approximately 75 per cent.

While this capacitor filter is applied independent of the load and can be used for an unlimited number of lamps, laboratory and field experience shows best results will be obtained by applying one capacitor per fixture. In the case of a long fixture, or a cove, one capacitor should be used with each eight feet of length.



25F214

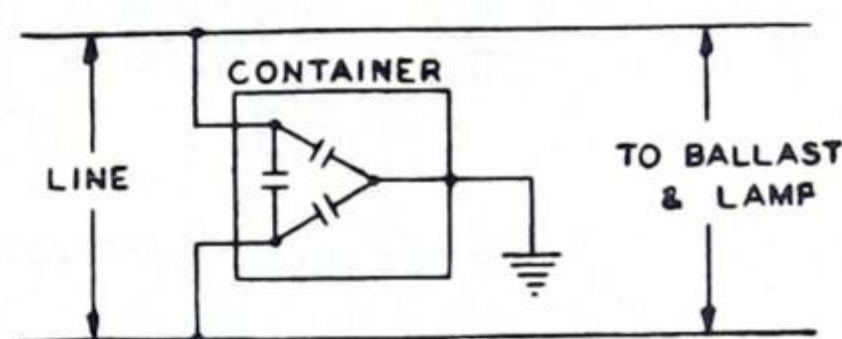

CIRCUIT DIAGRAM

Cat. No.	Volts AC 60 Cycles	Capacitance in Mu f	Dimensions	
			Body, Length	Diam.
25F214	Max. 220	.07-.07-.07	2 ³ / ₁₆ "	1"

For cases where it is desirable to further eliminate line noise, the inductive-capacitor type Catalogue No. 89G635, is recommended. This filter has a current-carrying capacity of 3.5 amperes which is about the load of eight 40-watt fluorescent lamps.



89G635

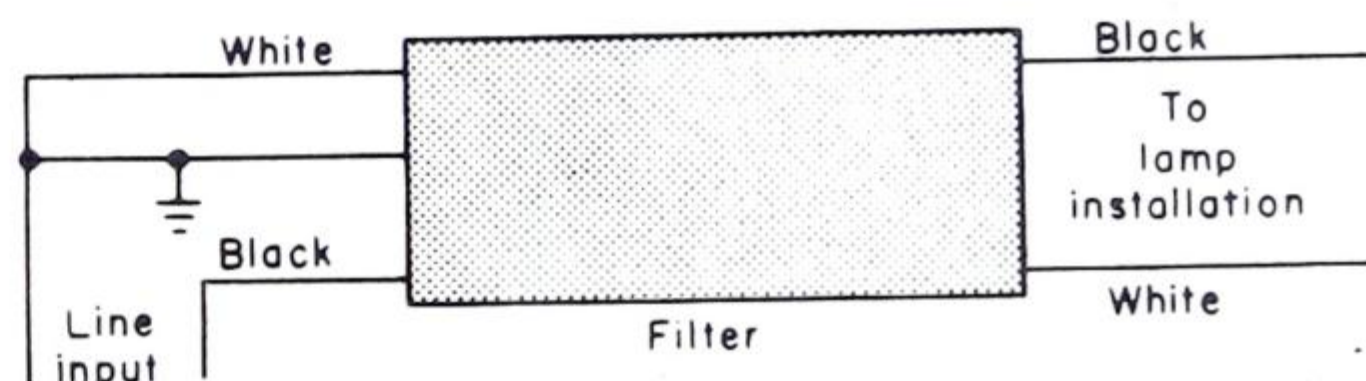

CIRCUIT DIAGRAM

Filter	Catalogue No.	Circuit Voltage	Max. Current	Dimensions		Approx. Watts Loss
				Overall Length	Width	
Reactor—Capacitor type	89G635	Max. 250	3.5 amps.	4 ²⁵ / ₃₂ "	2 ¹ / ₃₂ "	1 ¹ / ₂

Wiring Diagrams

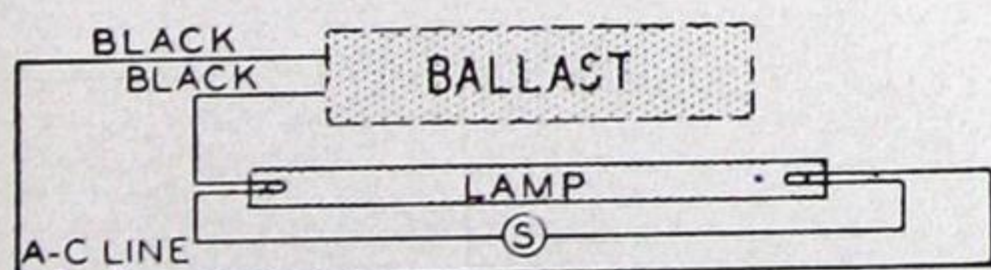

DIAGRAM 1

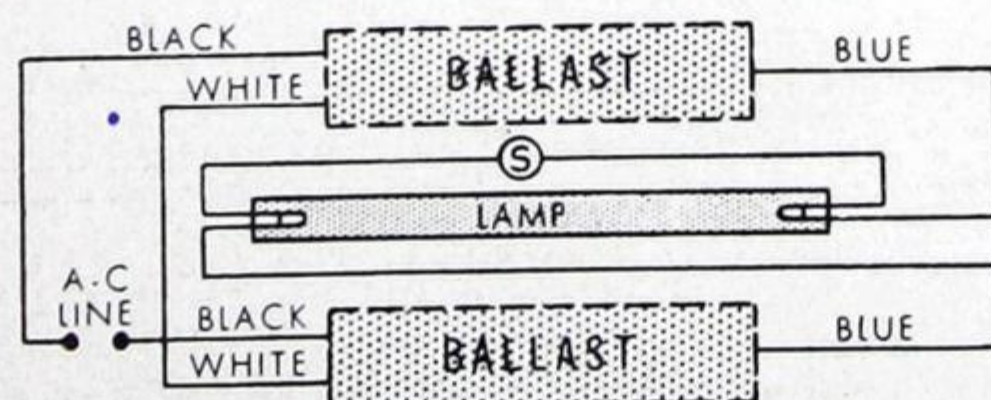

DIAGRAM 2

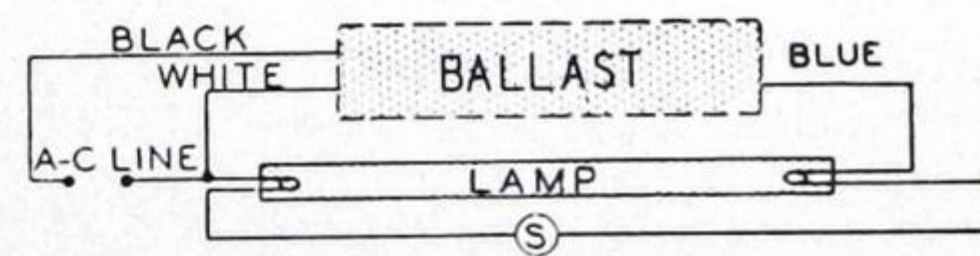

DIAGRAM 3



Wiring Diagrams

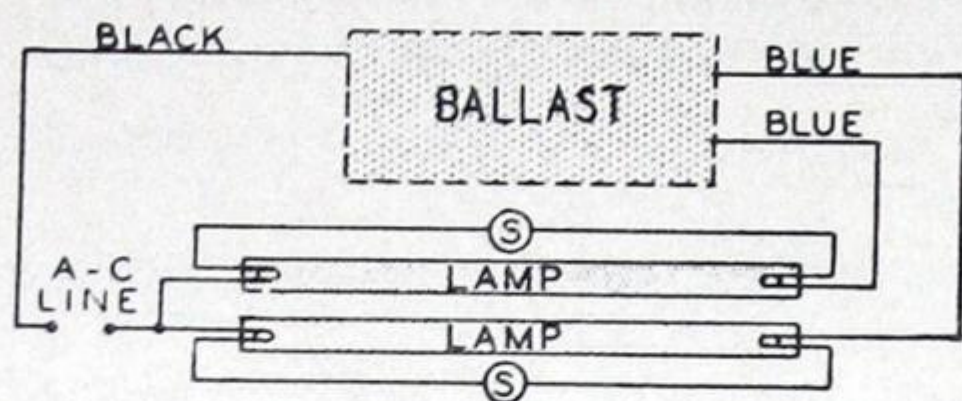

DIAGRAM 4

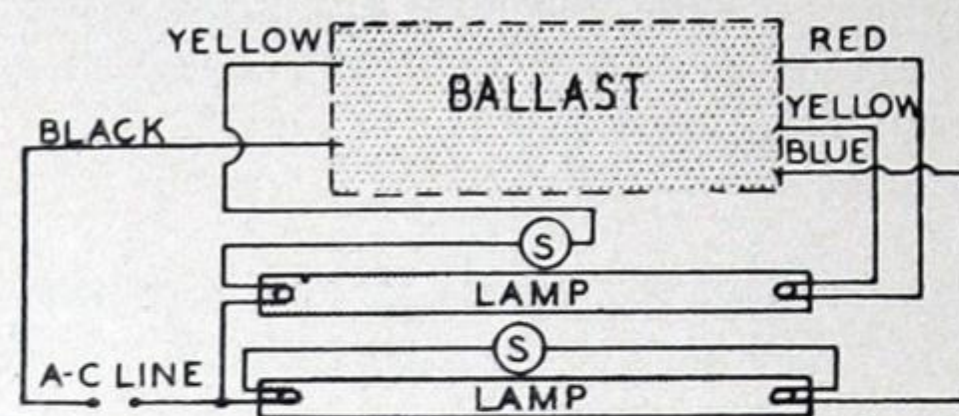

DIAGRAM 5

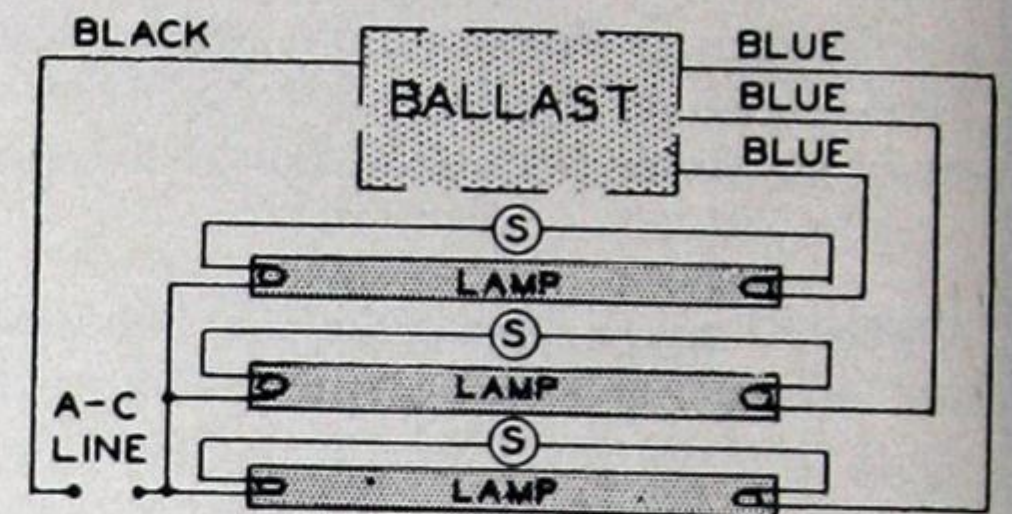

DIAGRAM 6

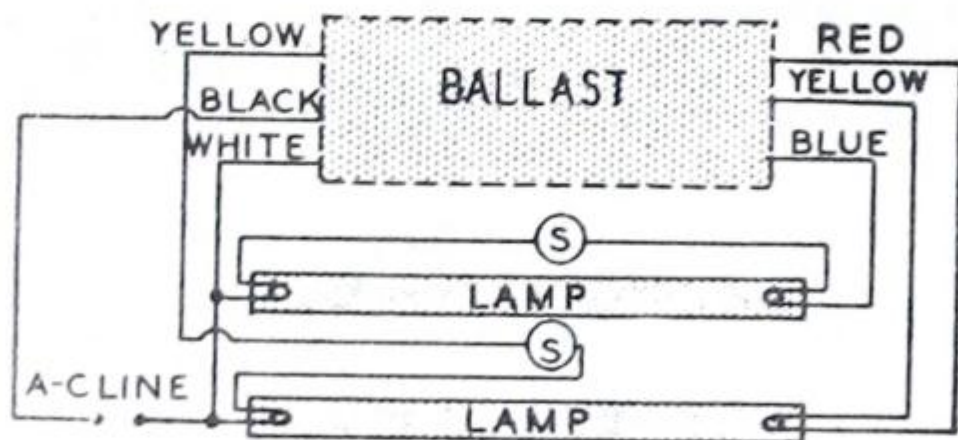

DIAGRAM 7

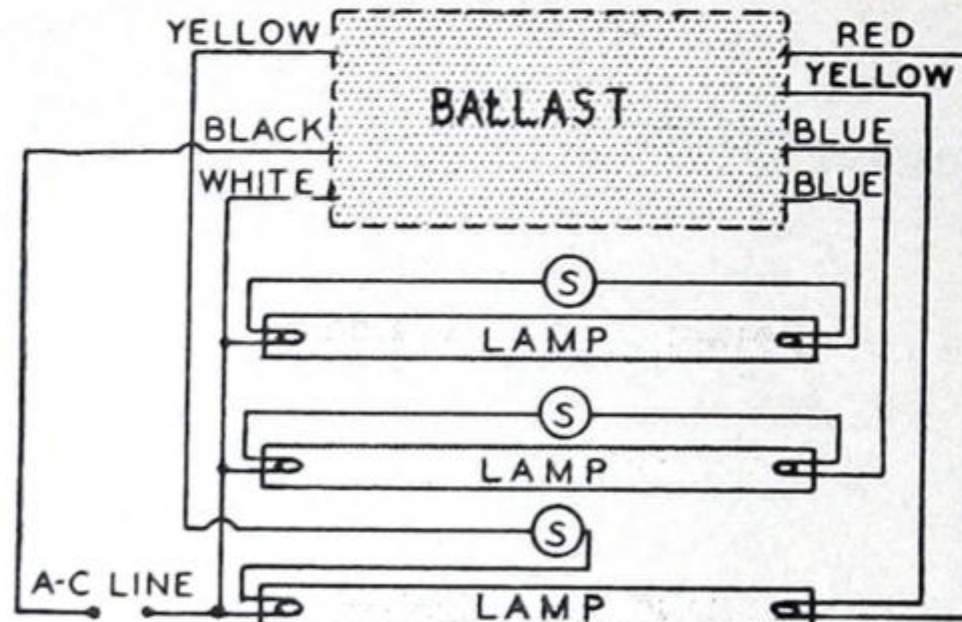

DIAGRAM 8

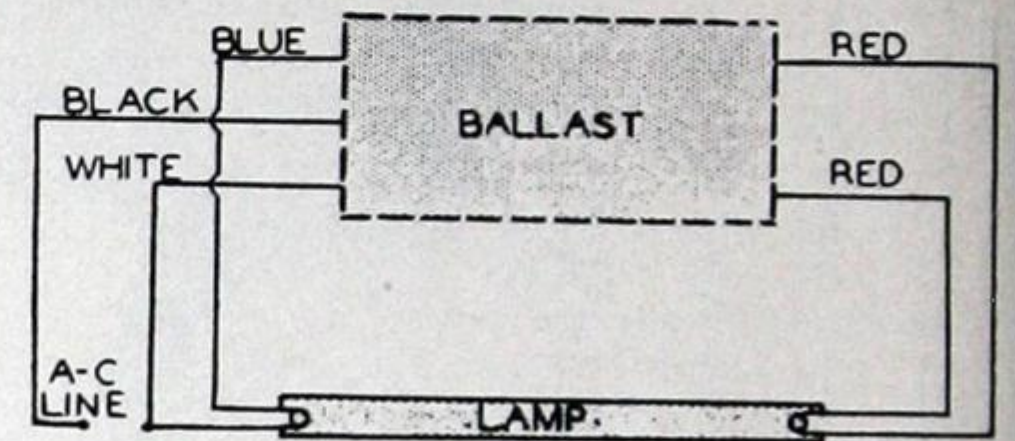

DIAGRAM 9

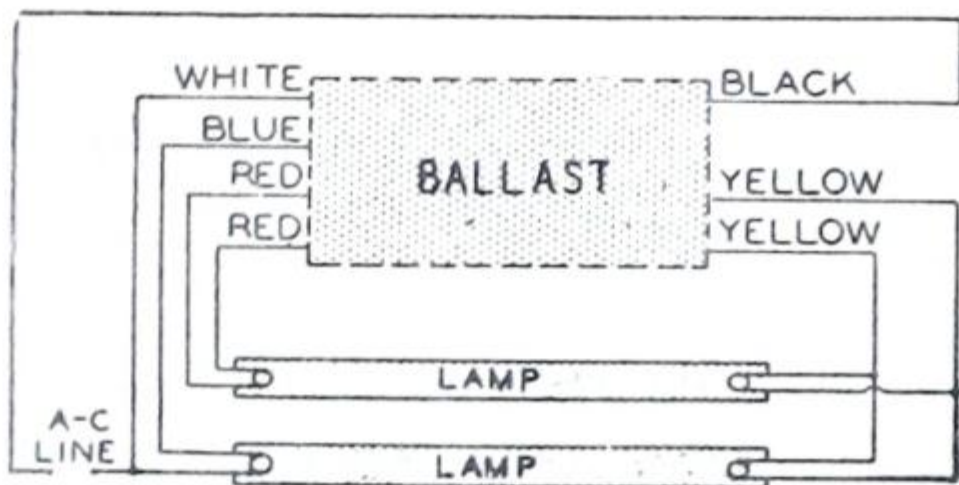

DIAGRAM 10

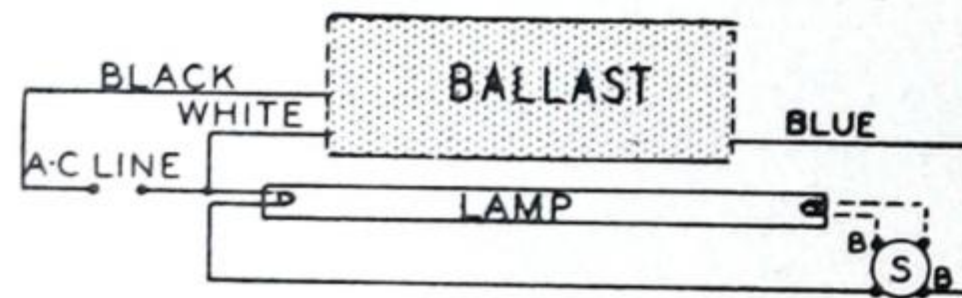

DIAGRAM 11

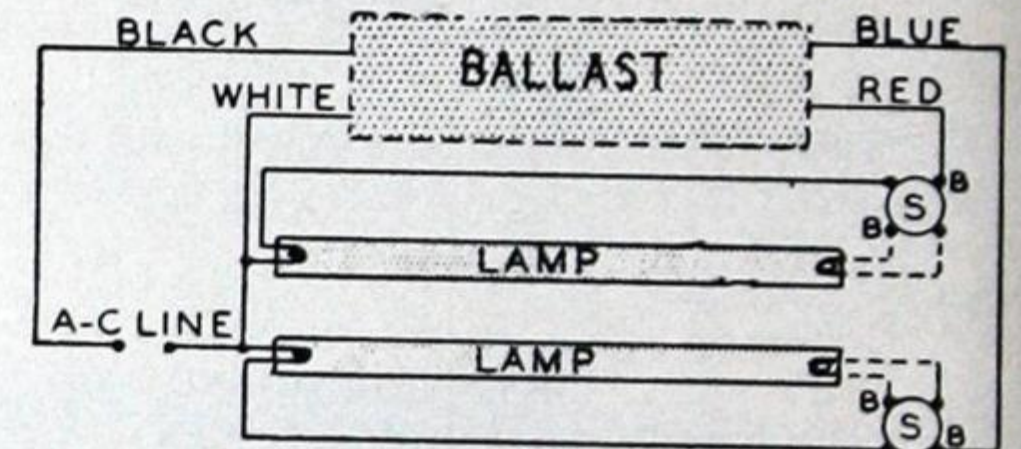

DIAGRAM 12

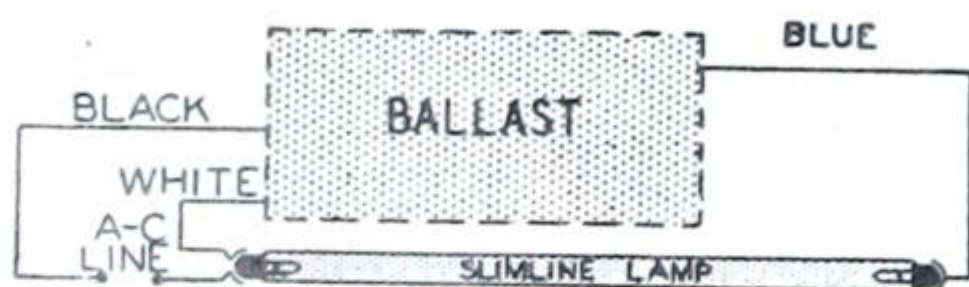

DIAGRAM 13



DIAGRAM 14

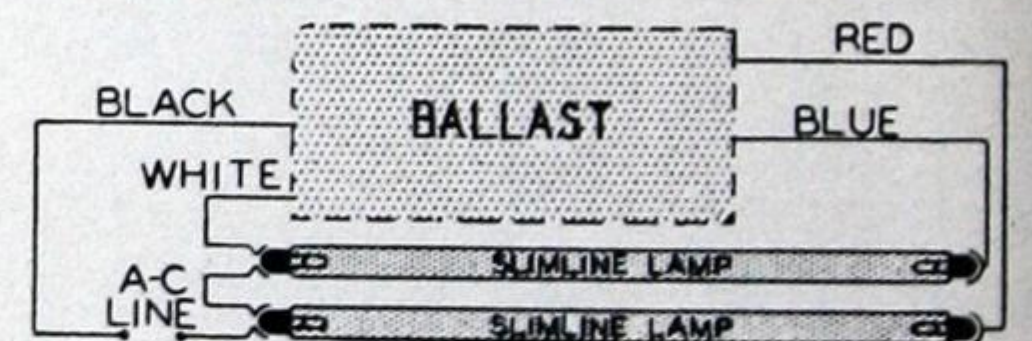

DIAGRAM 15

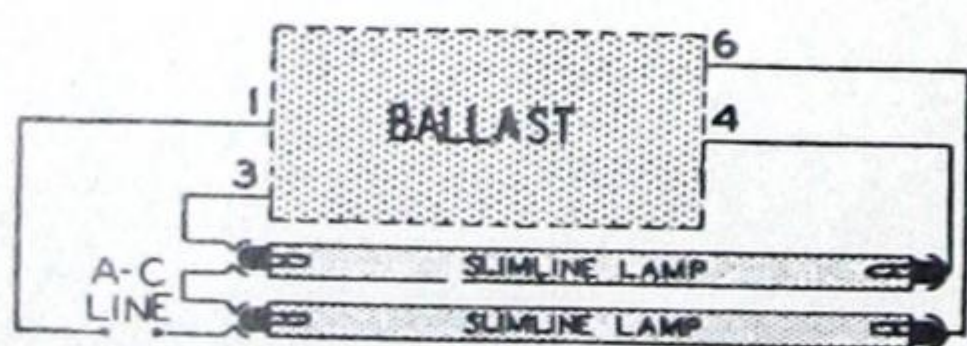

DIAGRAM 16

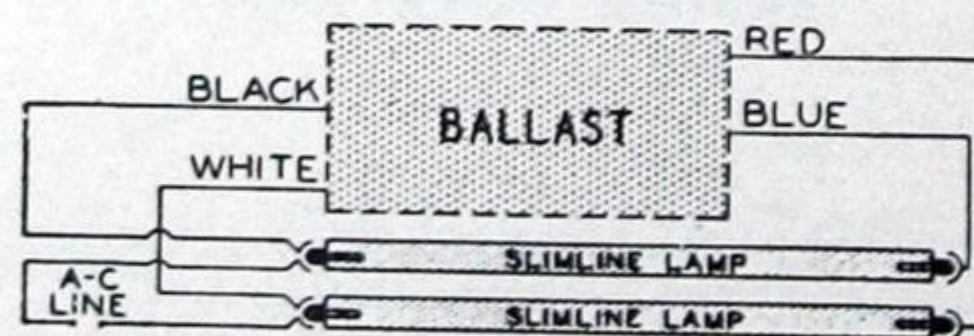

DIAGRAM 17

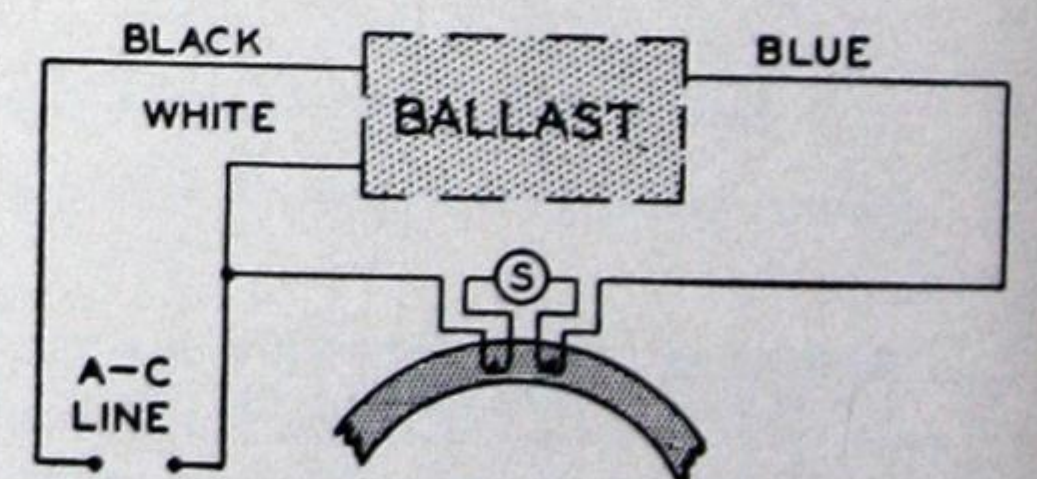
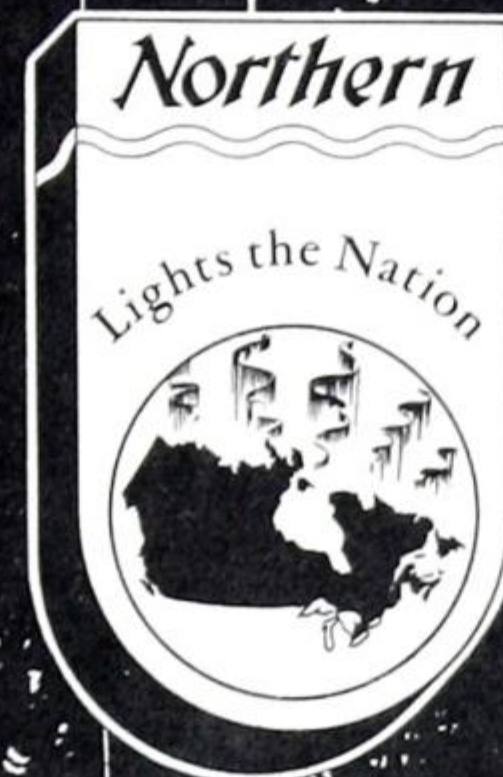

DIAGRAM 18



STAGE LIGHTING

CONTENTS

Design Data.....	186
Spotlights.....	191
Borderlights.....	193
Olivettes.....	195
Footlights (Disappearing).....	196
Footlights (Surface).....	198
Stage Pockets.....	199
Spotfloods.....	200
Accessories.....	201
Modulite Lighting Control.....	202

Use the
Northern Electric Lighting Service

DESIGN DATA FOR STAGE LIGHTING

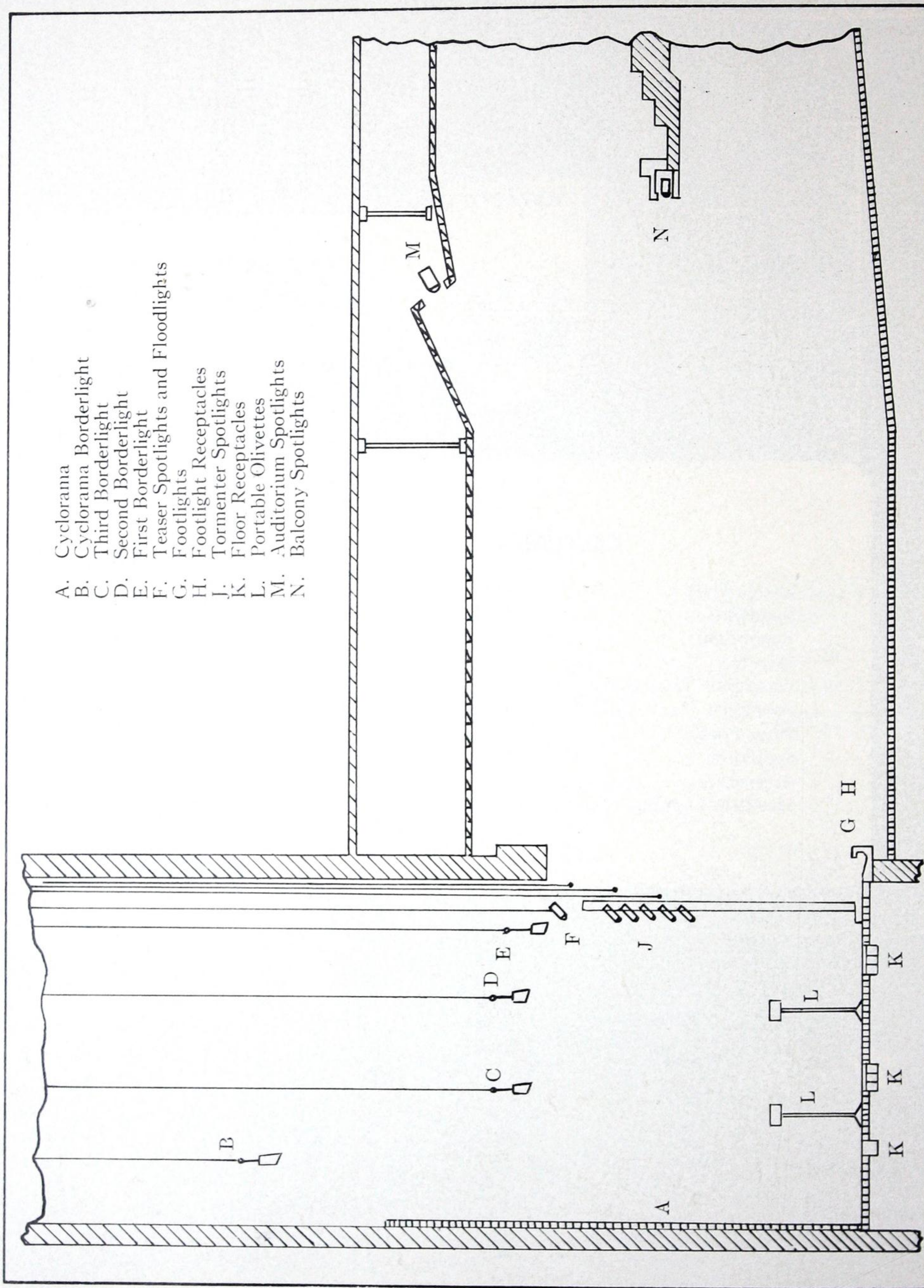

- A. Cyclorama
- B. Cyclorama Borderlight
- C. Third Borderlight
- D. Second Borderlight
- E. First Borderlight
- F. Teaser Spotlights and Floodlights
- G. Footlights
- H. Footlight Receptacles
- J. Tormenter Spotlights
- K. Floor Receptacles
- L. Portable Olivettes
- M. Auditorium Spotlights
- N. Balcony Spotlights

Typical Layout for Stage Lighting Equipment



DESIGN DATA FOR STAGE LIGHTING

Typical Layout for Stage Lighting Equipment

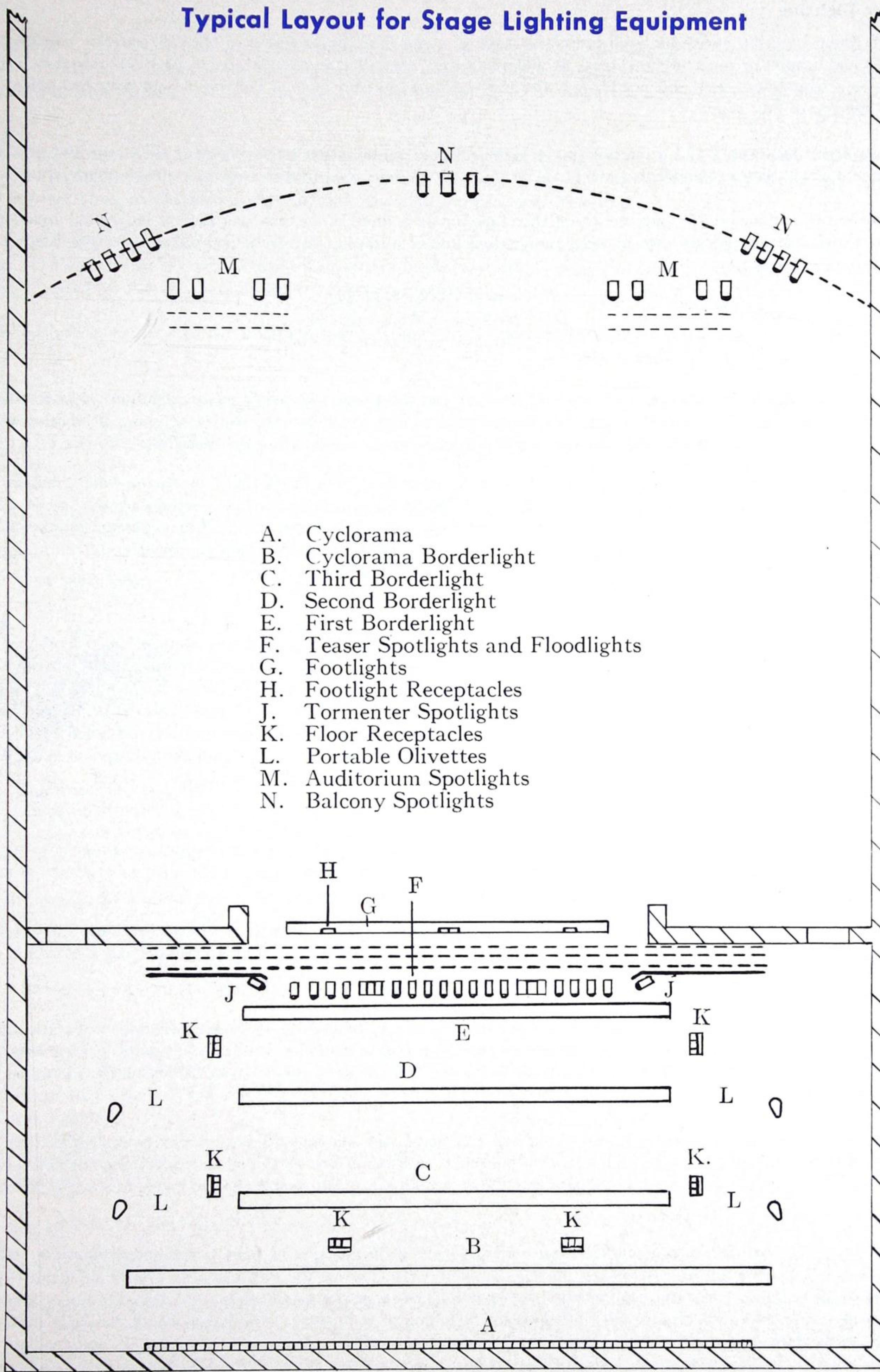

- A. Cyclorama
- B. Cyclorama Borderlight
- C. Third Borderlight
- D. Second Borderlight
- E. First Borderlight
- F. Teaser Spotlights and Floodlights
- G. Footlights
- H. Footlight Receptacles
- J. Tormenter Spotlights
- K. Floor Receptacles
- L. Portable Olivettes
- M. Auditorium Spotlights
- N. Balcony Spotlights



DESIGN DATA FOR STAGE LIGHTING

Planning Stage Lighting

The planning of Stage Lighting varies for each individual type of stage—for the professional theatre, variety, motion picture theatre, community halls and schools or repertory theatres. It will again vary according to the dictates of each individual location. Basically, however, the type of equipment used will not change and the fundamental principles of lighting design may be applied in one form or another to the lighting of any stage.

The entire acting area, the scenery and the artists must have sufficient illumination to complement the decor and provide comfortable seeing conditions for the audience, the lighting must also be confined to these areas and in most cases be completely unobtrusive.

It should be possible to emphasize any one section of the stage, or as is more often the case, several individual areas or artists and to create atmosphere and dramatic effects with lighting applications and colour mixing. To be completely effective, Stage Lighting should be made up of three components:

- (a) General Diffuse Lighting
- (b) Localized or Area Lighting
- (c) Dramatic and Colour Effects

Light and Colour

Illuminating engineering generally concerns itself with white light and the terms and definitions in common use pertain to white light. Actually this is a combination of several hues of coloured light and by the use of suitable filters we may, if we wish, eliminate all but any particular hue. The filter subtracts from the white light those colours not required in the final hue.

The filter may be a gelatine, glass screen or the glass envelope of the lamp itself. For Stage Lighting, three primary colours are commonly used, the combination of which produces white light. By mixing these colours in various proportions by the use of dimmers, a wide variety of coloured effects may be obtained. In some cases, additional white light from standard incandescent lamps is also used. The primary colours referred to are red, green and blue. To obtain yellow light, we would use a combination of red and green, to obtain magenta a combination of red and blue and to obtain white light, a combination of the three.

Lamps

Clear gas-filled general service and projector lamps are used for most standard Stage Lighting applications. Coloured lamps are not generally recommended, as they are available only in the smaller sizes and the red, blue and green lamps are not entirely suitable as true primaries for colour mixing. They are also very expensive. Clear lamps may be dipped in colour lacquer but this is also not recommended, due to the restriction in lamp sizes, the tendency of the lamp bulbs to become over-heated and the problems of again obtaining correct primary colours for colour mixing. The clear gas-filled lamp is best suited to modern optically designed Stage Lighting equipment and it is important that lamp sizes, types and burning positions, as recommended by the manufacturers of Stage Lighting equipment, be strictly adhered to to obtain maximum efficiency from the units and full life from the lamps.

Stage Lighting Equipment

For large scale productions in the professional theatre, visiting companies invariably carry some lighting equipment with them to supplement whatever may be available on the location. In planning a stage lighting layout, provision must be made to accommodate such auxiliary units as may be required for any particular production.

The average school or community hall stage, although not requiring such extensive apparatus as a professional stage, will be used for a great variety of activities and the lighting plan should, therefore, provide for as much equipment and as great a flexibility as possible.

Footlights

Footlights may be of the disappearing type which swivel on a hinge and may be lowered flush with the floor when not in use. These are used more extensively for smaller stages and schools wherein the stage area is used for other than dramatic productions. Alternatively, suitable units may be permanently installed at the front of the stage. These may be single or double row units, the upper row projecting about 3" above floor level.

Circuits may be arranged to control groups of lamps, fitted with red, green and blue filters to obtain maximum flexibility for colour mixing. The general intensity of light obtained with such a system is limited to some extent and in some cases where the extensive use of colour mixing is not required, additional circuits of white light may be incorporated. Circuits may be subdivided to facilitate control of centre stage or end sections.

Location of footlights, relative to the front curtain, must allow for even distribution of light to avoid spottiness in colour mixing. In cases where the stage is shallow and it is necessary for the artist to play close to the footlights, care must be taken to ensure that the light is projected over the whole body and not just the lower parts. The stage cannot be adequately lighted by footlights alone, borderlights are always necessary and are available with brackets for fastening to the ceiling. Footlights should be approximately 90% of the full width of the proscenium.

Depending upon the application, lamps of from 60 to 150 watts may be used, preferably housed in individual reflectors or compartments on spacings of 6", which will provide a glowing lamp per each colour every 18" on the standard three-colour layout.



DESIGN DATA FOR STAGE LIGHTING

Borderlights

The most satisfactory and most flexible method of obtaining even general lighting of the stage is by Overhead Lighting. This is achieved by the use of borderlights, a continuous trough made up of sections housing individual reflectors and extending the approximate width of the proscenium or stage opening. These units may be wired for colours and circuits in a similar manner to that described for the footlights.

The extent to which Borderlights can be used will be governed by many factors but wherever possible three or four rows should be installed, from 4' to 8' apart, depending upon wattage and lighting "throw". The first borderlight should be as close to the curtain as is practical and in some cases may be mounted at an angle directing the light slightly upstage.

When a fourth borderlight is installed, it is usually known as a Cyclorama Borderlight and is used almost entirely for dramatic colour lighting effects. The Cyclorama is a white stage background which is literally painted with light to obtain varying degrees of day or night effects, as a background for silhouettes and other dramatic presentations.

A "ground row" which is similar to a second row of footlights placed close to the Cyclorama is often used for supplementary lighting in such cases.

The method of mounting Borderlights and the height at which they are suspended will be dictated by local conditions. Care must always be taken to ensure that they are well out of sight of the audience. Usually, a teaser curtain is suspended in front of each borderlight and the borderlights are mounted on pipe battens in such a manner that complete sections may be lowered to allow for re-lamping and renewing or changing colour screens.

Lamp sizes vary from 100 to 500 watts and spacing from 6" to 12", the lamps being housed in individual reflectors or compartments double or single row borderlights being available.

Localized or Area Lighting

Olivettes

Olivettes are Stage Floodlighting units and may be equipped with colour frames as required. They are usually of the more concentrating type and may be used as overhead units or side lighting units mounted on telescopic stands. They are used for special Area or Effect Lighting and use 750 to 1000W lamps. Three to eight units may be required, depending on the type of productions presented.

Spotlights

Spotlights are the most important item of Stage Lighting Equipment. Borderlights and Footlights simply provide general overall illumination and a stage requires more than just this illumination. Character and atmosphere must be provided upon the stage and equipment available to create or kill shadows, produce highlights and silhouettes and dramatize any aspect of the characterization of the story. This is achieved to a large extent by the use of spotlights.

Spotlights should always be equipped with reflectors and the position of the lamp relative to the lens of the unit must be adjustable in order that the size of the beam or spot of light may be controlled. There should be provision for the use of colour filters—well ventilated and mounted in such a manner that the direction of the beam may be easily changed from one position to another.

Spotlights may be divided into several groups according to their particular application.

One set mounted on a Spot Bar between the proscenium arch and the first borderlight and a little below known as the teaser spots. They may be a continuous row or mounted in groups with Floodlights or Olivettes between each group, called a "Teaser Spot or Flood Batten". The entire row should extend the full width of the proscenium. The second group, known as Tormentor Spots, are mounted on special vertical Pipe Battens down each side of the proscenium arch and may consist of any number of units, depending upon the requirements of a particular production.

Wing Spots, as the name implies, are mounted in the wings erected on telescopic stands, or directly to the wing structure if this is of a semi-permanent nature.

Special Spots may be added to Borderlight Pipe Battens, or located in the Footlights as required.

When structural conditions permit, from 8 to 10 spotlights mounted in the ceiling of the auditorium may be used to good advantage.

Finally, a set of Balcony Spots, arranged either in one group or separate groups may be installed in front of the balcony.

Except where special effects are required, great care must be taken to balance the general diffuse lighting from the foots and borderlights, with the accent lighting from spotlights and olivettes. This is essential to avoid shadows being cast upon the scenery or by the artists upon each other as they move about the stage. The direction of the light is as important as the intensity, and careful aiming of the spots will add greatly to their effectiveness.



DESIGN DATA FOR STAGE LIGHTING

Lighting Control

Because of the extreme flexibility required in Stage Lighting and the need for a fair amount of portable equipment, a considerable number of permanently wired stage pockets must be provided and the entire electrical system must be controlled from a central switchboard.

The stage pockets should be mounted below stage floor level and protected by a flush fitting hinged lid, provided with holes for cable entry. These pockets are available with from two to six outlets and are usually rated from 25 to 100 amperes. Each receptacle should be on a separate circuit. Some stage pockets may be equipped with lamp indicators to show when the circuit is alive and they may also be equipped with colour discs to locate the different colour circuits. The pockets should be located on each side of the stage outside the acting area, two or three feet from the line of the proscenium opening and equally spaced from front to back. Additional wall pockets may also be mounted at convenient locations. Stage pockets should be as numerous as possible and borderlights equipped with additional plug receptacles.

The Switchboard and Dimmer Control

A full discussion of switchboards and dimmer control is beyond the scope of this section. In most cases, the control of such lighting is tailor-made to suit each individual job.

For modern stage lighting, it is the dimmers and not the switches that afford the greatest flexibility in producing a wide variety of lighting effects. In planning the methods of control three factors must be considered. The number of dimmers required, the type of dimmers to be used and the method of controlling the dimmers.

Ideally, each individual circuit should be provided with dimmer control but economic considerations usually dictate a compromise and an arrangement whereby individual dimmers may be plugged in to control several different circuits. This usually works out quite well in practice, as it is seldom that all dimmers connected to individual circuits are in use at one time.

It is often wiser to plan an installation so that the initial design is adequate to control the total amount of equipment envisaged as the ultimate objective, which with a modest amount of lighting equipment may be used with good results. Additional dimmers and lighting equipment may be added at a later date. It is most important that the initial installation of the electrical service be adequate to feed the maximum amount of equipment anticipated. The extent to which dramatic lighting effects and colour mixing can be used is dependent almost entirely upon dimmer control and these considerations should be given more attention than the slow reduction of stage lighting from full brightness to blackout.

Four main types of dimmers are, at present, being manufactured and used in Stage Switchboards. They are:—

1. Resistance Dimmers;
2. Reactor Dimmers;
3. Auto-Transformer Dimmers;
4. Electronic Tube Dimmers.

Of these types only three can be considered, seriously, for a modern system of Stage Lighting Control. The now "old-fashioned" resistance dimmer dims the lighting by means of a variable resistance device. Appreciable heat is generated by such a resistor, and this type of dimmer must be fully loaded to its rated capacity before it will operate efficiently.

Of the three remaining types, only two are available for use in both Manual and Remote Control boards—the Electronic tube type being made only in Remote Control Systems.

A manual type switchboard is less costly than the remote style but is bulky and all operations such as moving the dimmer control handles and switching for contactors and other phases of control must be done at the face of the switchboard itself—said switchboard necessarily being located on the stage.

The remote control system is by far the most advanced and popular of any. With this type of layout, the actual switchboard with the dimmers, contactors, etc., may be located anywhere in the building from the basement to the attic. The location is usually made handy to the lighting loads and the service to the board to reduce cable runs and effect the obvious reduction in voltage drop and installation problems.

On the Remote Control type the Control Board itself is a small item (an 18 dimmer switchboard with a capacity of 72kw. has a portable control station weighing only 22 lbs.) and is made in many combinations. The portable control station is one which has all the control wiring terminating in a multi-contact plug. This plug may be plugged into any number of plug-in stations desired and the complete switchboard can be thusly controlled from the projection booth, the seat in the theatre proper, back stage, etc. It is of noteworthy interest that such a system uses 24 volts on the "control circuit" and is obviously absolutely safe and foolproof.

All necessary dimmer, contactor, blackout, and other such usual controls are duplicated in miniature on this control station which—besides the portable type—may be manufactured permanently mounted in a desk type console, or flush in a wall backstage, or in the projection booth.

Stage Lighting is essentially an art and is one which can only be fully mastered by a considerable amount of practical experience. It is undoubtedly the most important part of the production of any stage presentation. It should, however, be so natural and so unobtrusive that the audience is completely unaware of its presence.



SPOTLIGHTS

Selection and Use of Spotlights

Spotlights have a wide range of usefulness yet they project exactly what the name implies, a Spot of Light. The Location of the spotlight in relation to the location of the Spot of Light desired determines the length of throw. The diameter and intensity of the light spot guides the selection between 8" lens, 6" lens and 4½" Baby lens. Naturally the size of lamp affects the intensity. It is well to remember also the more concentrated the area of the spot of light the greater the intensity. Make your selection of a type that gives the best results somewhere between the minimum and maximum performance so that a margin each way is available. Major Spotlights are precise, yet they have a wide range of focus for general use. If your circumstances are unusual or you require assistance in the selection of suitable equipment:—

—CONSULT YOUR LOCAL NORTHERN ELECTRIC OFFICE—

Features of the "Major" 6" & 8" Spotlights

VENTILATION

Designed with light-proof holes of ample size entirely across the top affording perfect ventilation.

HOOD

All Major Spotlight Hoods are made of galvanized iron and will not rust; finished in Black Kristokrak that is heat-resisting and attractive.

COLOUR FRAME HOLDERS

Made of ⅛" sheet aluminum and fitted with a spring tension device which keeps the frame tight against the front, eliminating leakage of white light and preventing colour frame from falling out when spotlight is moved about.

LENS AND HOLDERS

High polish imported lens that does not discolour. Lens held in position with brass spring in a special groove which prevents lens from falling out.

SUPPORTS

The yoke is securely attached and can be supplied with 2 piece Cast Aluminum Pipe Clamp or substantial Pipe Stand Support with heavy cast iron Floor Base.

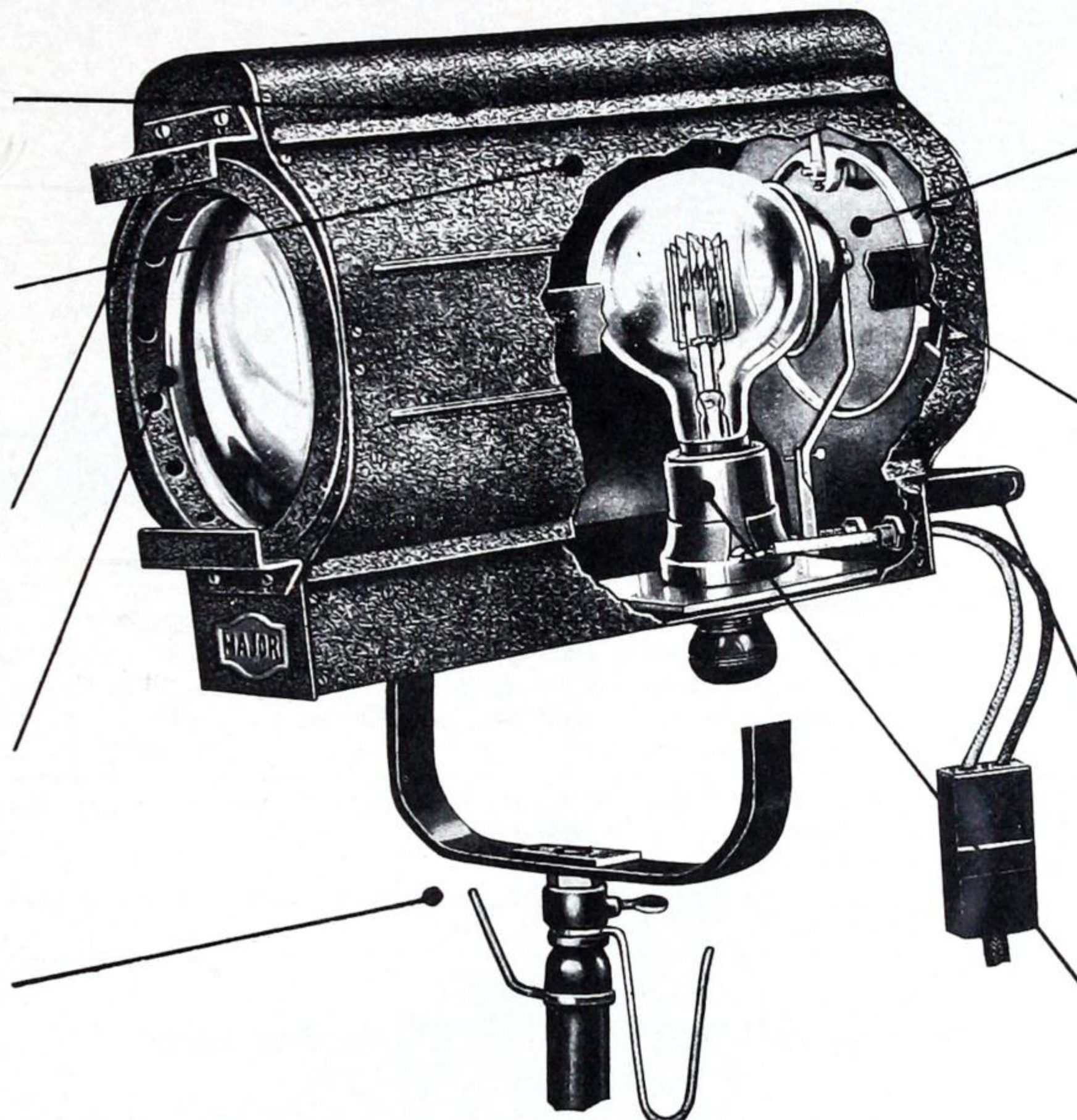

NO LIGHT LEAKAGE

The Rear Access Door has a cast aluminum flange around the edge so that light cannot escape. A strong latch is provided that eliminates possibility of rattle. The entire spotlight is enclosed by a double wall with air space between. Linings overlap allowing circulation without light leakage.

RIGID REINFORCEMENT

A continuous frame, fixed between cast aluminum front and back plates, is drilled and tapped to hold the hand wheel fittings and reinforce the spotlight and supporting yoke, thus giving rigidity that will withstand hard usage.

COOL HANDLING

A Heavy Spade Wood Handle provides an easy and cool hand grip. A large Bakelite Knob operates the sliding channel carrying the Prefocus Socket and lamp assembly to and fro. They work smoothly, quietly and because of the ventilation and slot-closing devices they are cool and leak-light proof.

PREFOCUS SOCKET

The socket is set by experts at the factory and remains fixed perfectly, regardless of the number of lamps used. It is **never** necessary to refocus either a new lamp or reflector.

ELECTRICAL EQUIPMENT

MAJOR Spotlights with the Pipe Stand Support are equipped with 3 feet of moving picture machine heavy asbestos cable, 15 ampere slip connector, and 25 feet of extra flexible No. 14 Stage Cable. Spotlights ordered with Yoke only or with Pipe Clamp Support are equipped with 3 feet of moving picture machine heavy asbestos cable only.

Chart of Spot Areas

These charts will be of assistance in the selection of suitable spotlights. The numerals are in feet, both as to length of throw and diameters of spot areas. For example an 8" lens spotlight will throw a maximum spot of light, 45 feet in diameter, at a distance of fifty feet. The same spotlight will project a minimum spot of light 9 feet in diameter at fifty feet. Any sized spot between these diameters is, of course, available.

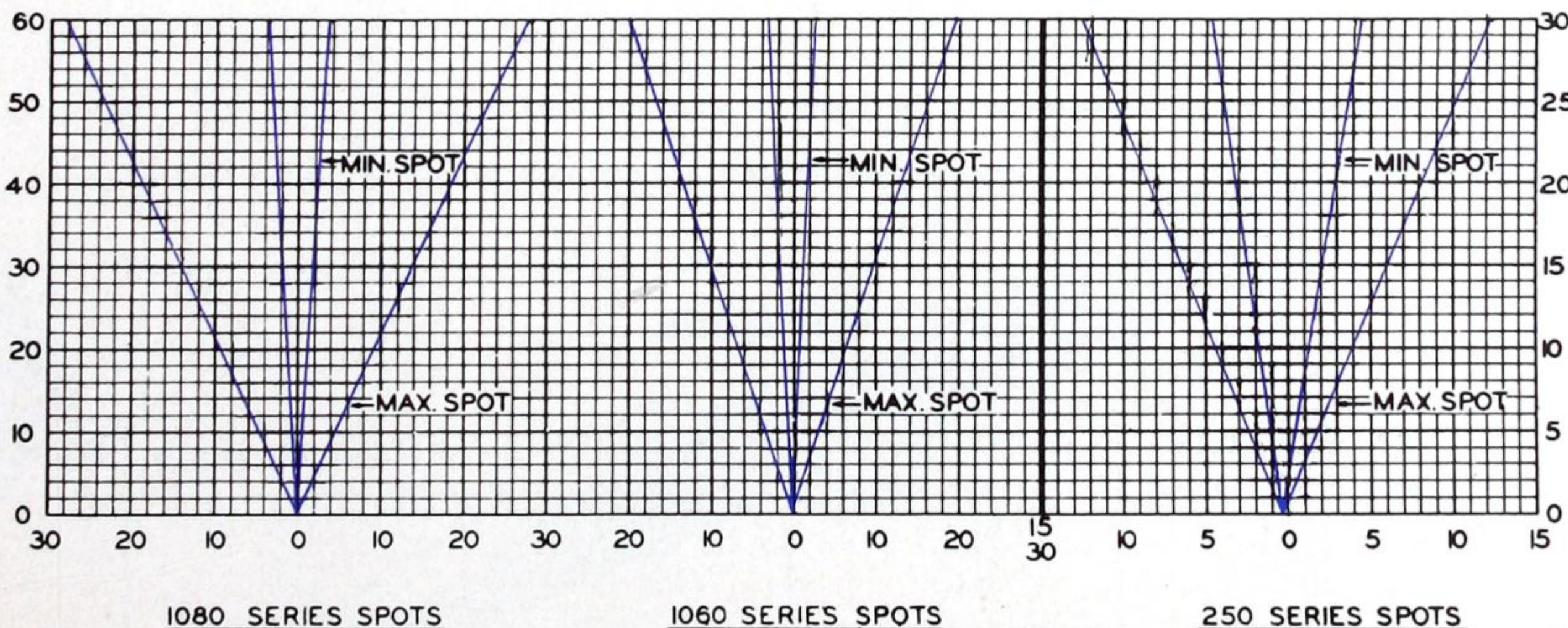



SPOTLIGHTS

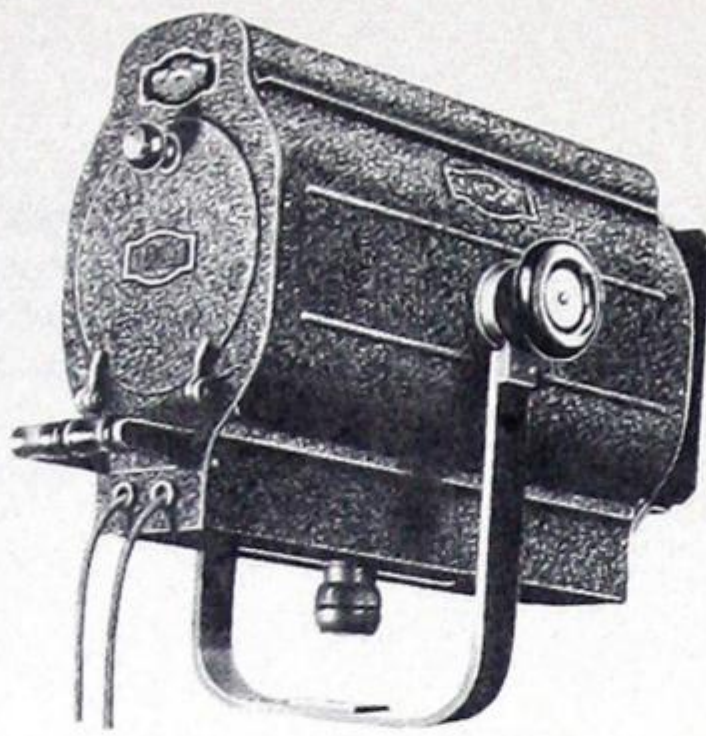

UNIT WITH YOKE ONLY.

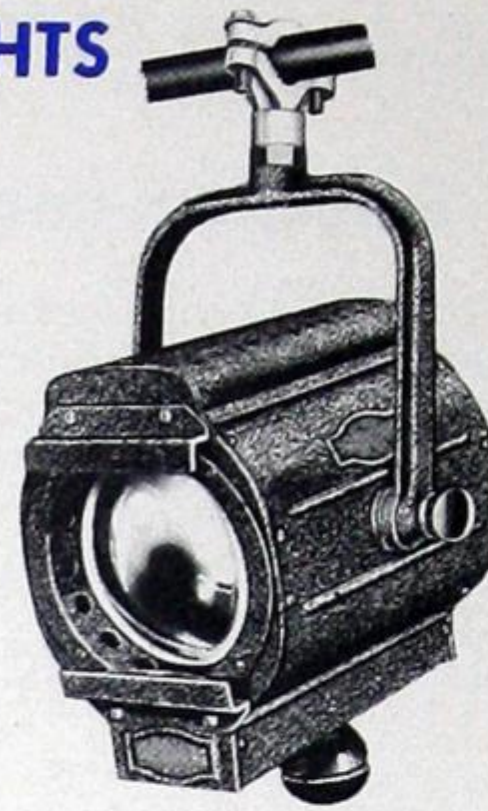

UNIT WITH PIPE CLAMP SUPPORT.

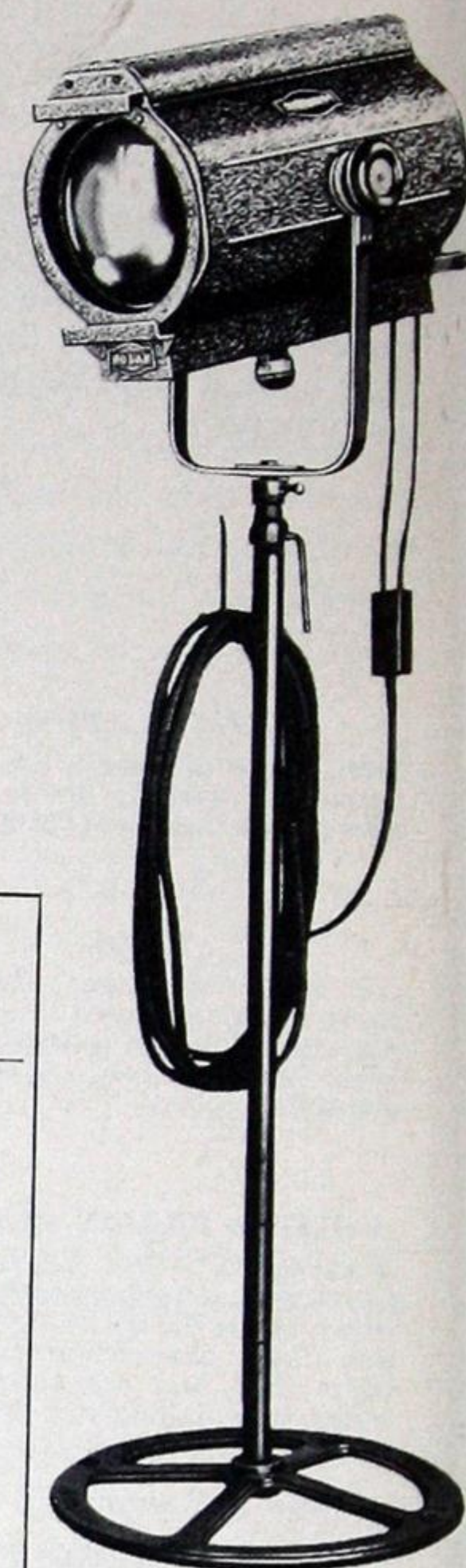

UNIT WITH STAND AND CABLE.

Spotlights 6"-8" Diameter Lenses

Use 1000W G40 mogul prefocus base spotlight type lamp. Light center length 3¹⁵/₁₆".

**Cat. No.	Lens Diam.	Accessories	Cable	Colour Frames Supplied	Shipping Weight
1060	6"	Adjustable stand, 18" diam. base	25' No. 14 Stage cable slip connector	1 (No. 106)	40 lbs.
1080 *	8"	Adjustable stand, 18" diam. base	25' No. 14 Stage cable slip connector	1 (No. 108)	52 lbs.
1061	6"	Yoke only, no stand or fittings	3' No. 12 Asbestos cord	1 (No. 106)	26 lbs.
1081 *	8"	Yoke only, no stand or fittings	3' No. 12 Asbestos cord	1 (No. 108)	29 lbs.
1062	6"	Cast aluminum pipe clamp, and nipple for use on pipe batten	2' No. 12 Asbestos cord	1 (No. 106)	29 lbs.
1082 *	8"	Cast aluminum pipe clamp, and nipple for use on pipe batten	2' No. 12 Asbestos cord	1 (No. 108)	32 lbs.

*—The 8" lens spotlights may be used with a 1500 watt or 2000 watt lamp only if equipped with Major Pyrex heat-resisting 8" lens. This special lens will be supplied if specified.
 **—All spotlights finished in Black Kristokrak.
 Prefocus base sockets are standard equipment, but screw base sockets to accommodate standard screw base lamps will be supplied if specified.

Baby Spotlights — 4½" Diameter Lens

Use either 250W or 400W G30 medium prefocus base spotlight type lamp. Light center length 2³/₁₆".

Cat. No.	Accessories	Cable	Colour Frames Supplied	Shipping Weight
250	Single non-telescoping pipe stand	25' No. 14 Stage cable Slip connector	1 (No. 40)	30 lbs.
251	Yoke only—no stand or fittings	3' No. 12 Asbestos cord	1 (No. 40)	17 lbs.
252	Clamp and pipe nipple complete, for use on pipe batten	2' No. 12 Asbestos cord	1 (No. 40)	18 lbs.

Prefocus base sockets are standard equipment, but screw base sockets to accommodate standard screw base lamps will be supplied if specified.

Dimensions

Series	Overall Length	Overall Width	Height, Hood only	Length, Hood only	Width, Hood only
1060	18 ³ / ₄ "	12"	15"	16 ¹ / ₄ "	8"
1080	19 ³ / ₄ "	14 ¹ / ₂ "	15 ³ / ₈ "	17 ¹ / ₄ "	10 ¹ / ₂ "
250	10"	7 ¹ / ₂ "	8"	8 ¹ / ₂ "	6"



BORDERLIGHTS

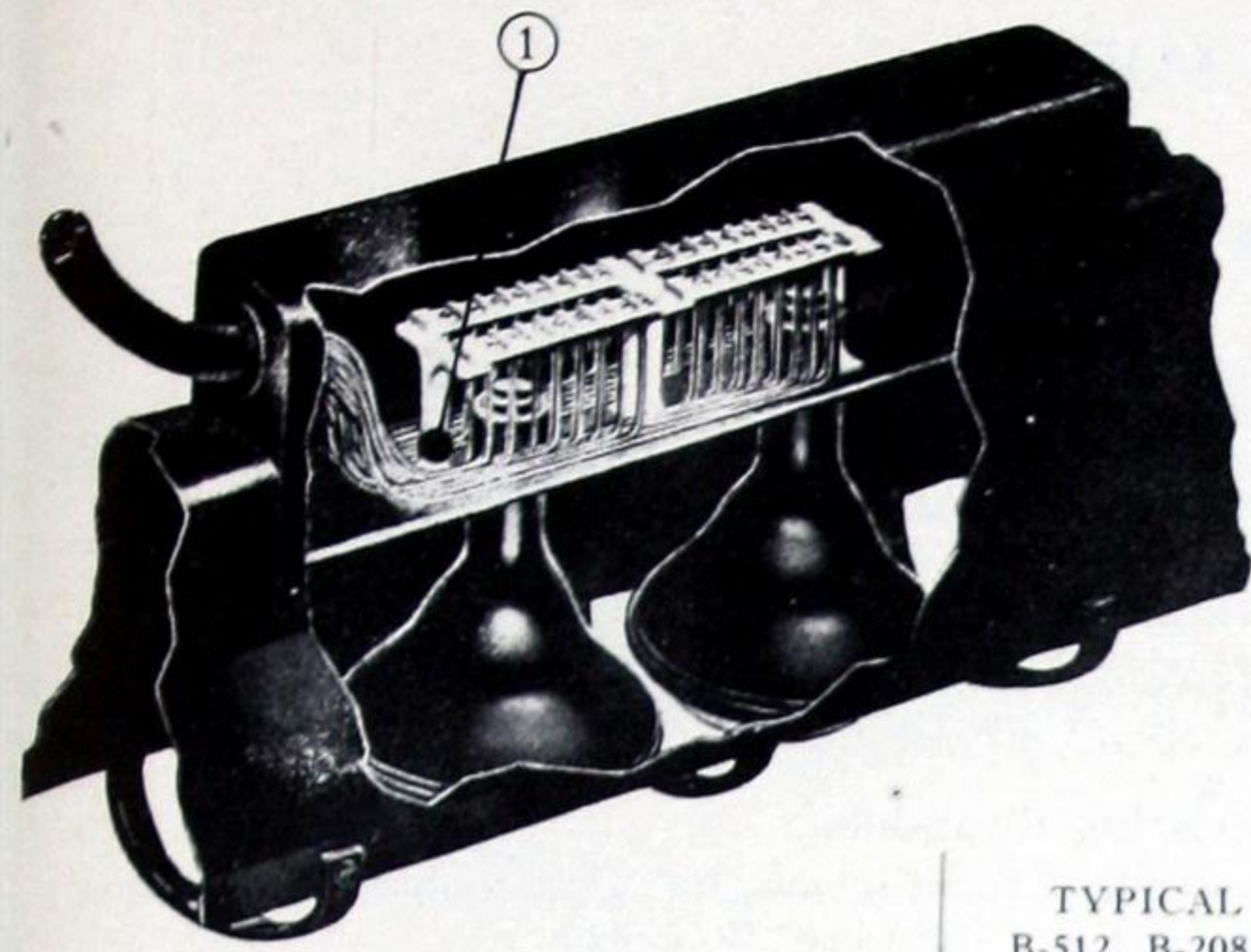

1

TYPICAL OF TYPES
B-512, B-208, B-156, B-106



2

3



4

TYPE B-2R

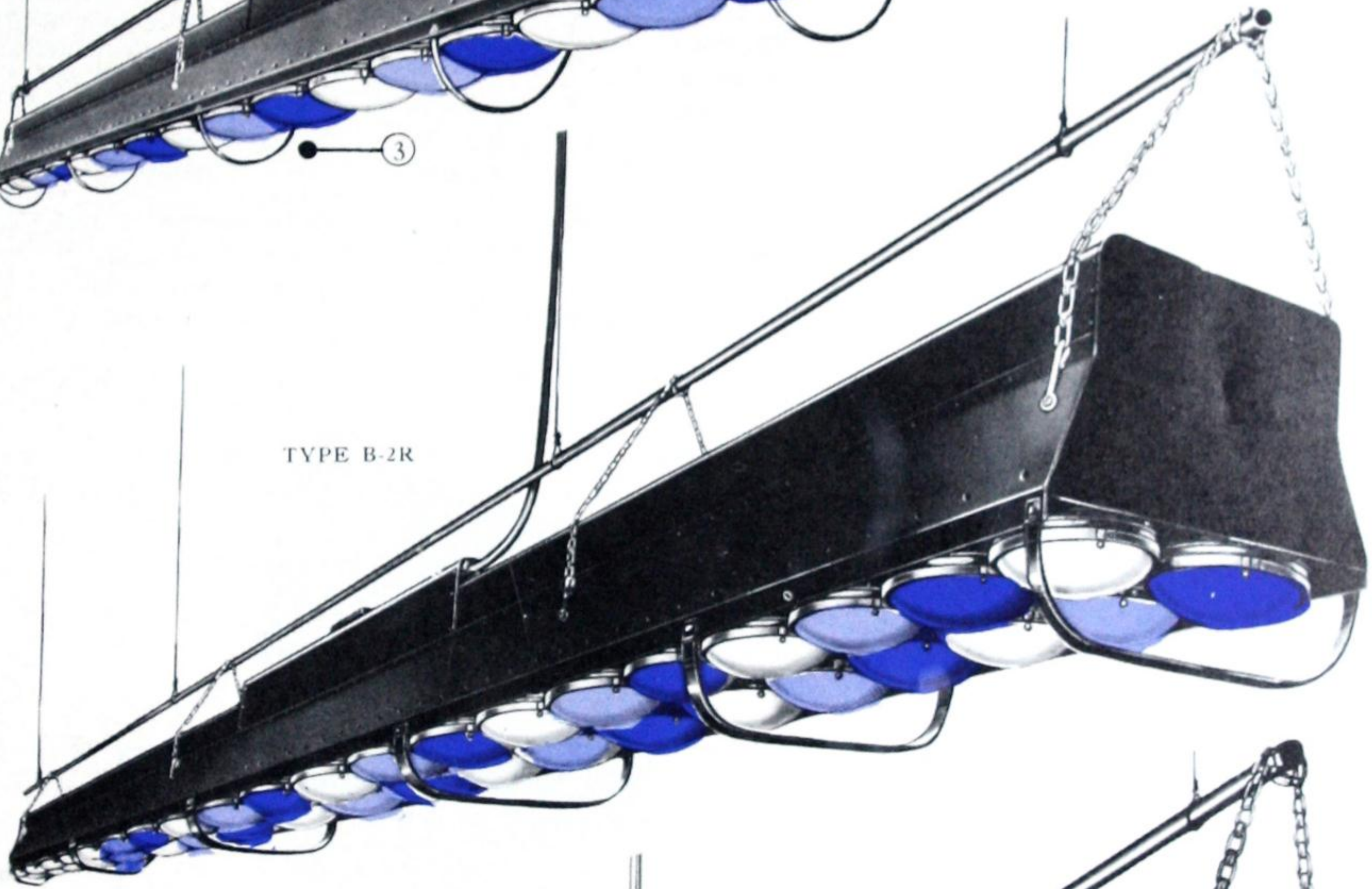

TYPE B-103





BORDERLIGHTS

Borderlight Features

1—New Terminal Strip Splice Box

A superior type of wiring box wherein the terminal connections may be quickly and easily connected for all circuits. A great convenience and time saver. This eliminates soldered and taped joints and affords a simplified arrangement for testing or changing.

2—Chain Hangers

These allow borderlights to be tilted for direction of light beams.

3—Anti-fouling Guards

Heavy guards protect glass and prevent stage drops from becoming fouled.

4—Alzak Reflectors

Efficient Alzak reflectors having the highest reflective power of any known practical medium.

5—Slip Retaining Rings

Use either roundels or gelatine frames, making relamping very simple as the use of one hand only is necessary.

6—Heat-Resisting Roundels

Natural coloured heat-resisting moulded glass roundels made by a special process are safe from heat breakage.

*Type	Lamp	Socket Type	Centers	Includes	Shipping Weight
B-512	500W PS40 or 300W PS35	Mogul	12"	Terminal connection block, chain hangers and one glass roundel for each reflector. (specify colours required)	22 lbs./ft.
B-208	200W PS30	Medium	8"		18 lbs./ft.
B-156	150W PS25	Medium	6"		15 lbs./ft.
B-106	100W or 60W A21	Medium	6"		14 lbs./ft.
B-2R	60W—500W	Specify	Specify		—
B-103	Up to 100W A21	Medium	4"	As above. Less roundels	9 lbs./ft.

*All Borderlights wired for colours and circuits to customer's specifications.

Finish: dead black.

Special receptacle (for spotlight or upper worklight) wired on separate circuit supplied if specified.

Upper worklight Cat. No. W-150 for mounting on pipe batten, with pipe clamp, including cable and plug for plugging in special receptacle in borderlight furnished if specified.

Gelatine colour frames may be used in place of colour roundels and will be supplied if specified.

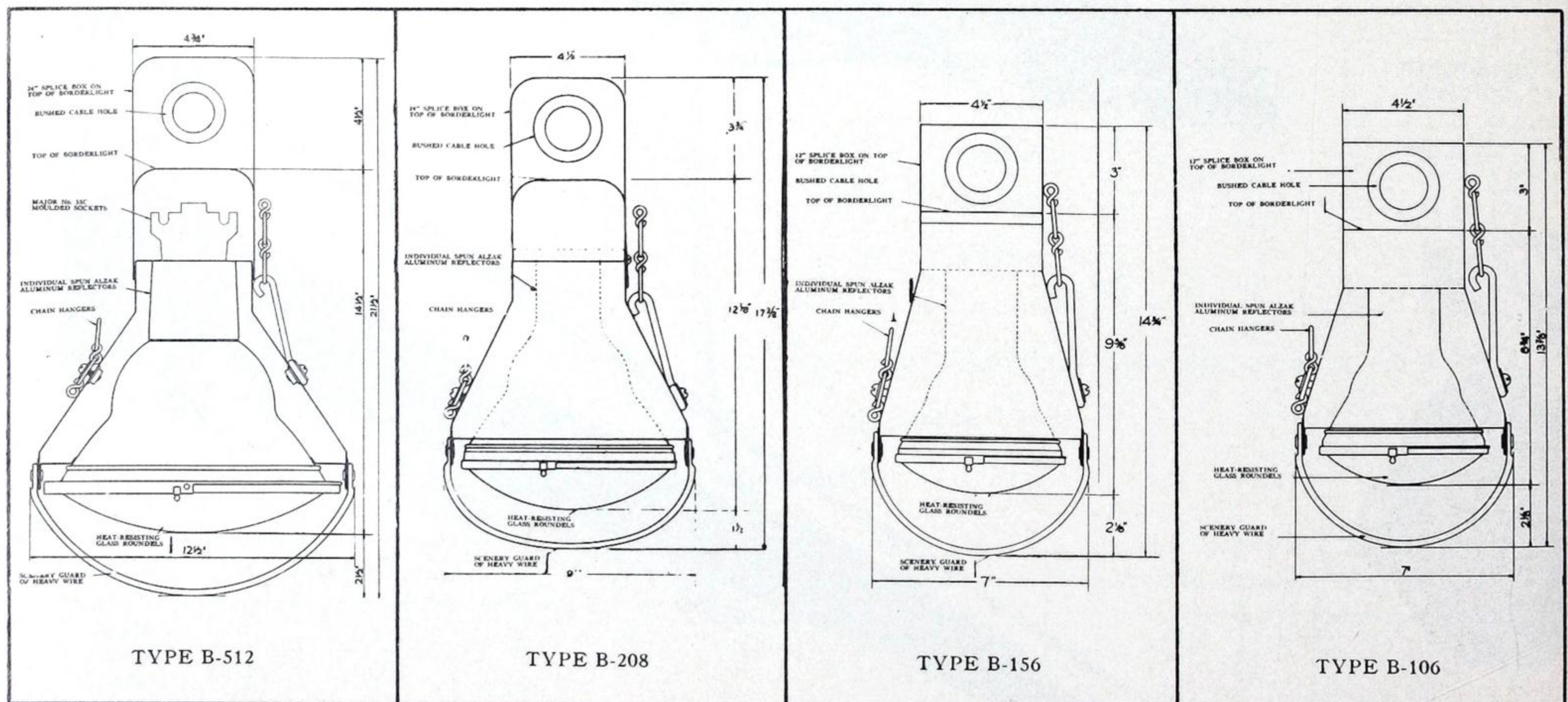



BOX LIGHTS AND OLIVETTES

Box Lights with Individual Alzak Reflectors

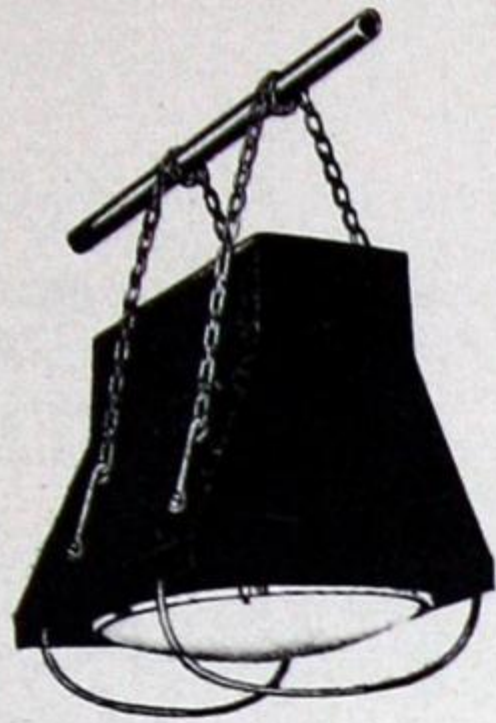

350-6100

These new designs for Box Lights with individual Alzak reflectors make excellent units for overhead floodlighting. A series of these provide a tremendous amount of illumination of more flexible control, both for colour and position, than a border light. The Box Light has great stability, good ventilation, and a smooth exterior that even a gauze drop will pass without fouling. Made in two sizes, each a unit spun Alzak aluminum reflector with colour or clear roundels. The use of roundels (which is standard equipment) is recommended but, if specified, these box lights may be supplied equipped for use with colour frames instead of roundels.



351-6101

Type	Lamp	Socket	Suspension	Cable	*Roundels supplied (Specify Colour)	Shipping Weight
350	300W PS35 or 500W PS40	Mogul	Chain hangers	2' Asbestos cord	1	22 lbs.
351	300W PS35 or 500W PS40	Mogul	Clamp hanger Light duty 1''-2''	2' Asbestos cord	1	22 lbs.
6100	750W- 1500W PS52	Mogul	Chain hangers	2' Asbestos cord	1	45 lbs.
6101	750W- 1500W PS52	Mogul	Clamp hanger Heavy duty 1''-2''	2' Asbestos cord	1	45 lbs.

*Diffusing roundels in clear, red, blue, amber, green, yellow, and revelation roundels also available.

Olivettes

ALZAK processed reflectors with a reflective factor of 85% have the highest reflective power of any known practical medium. Does not tarnish—is slow to collect dirt—will not crack or peel and is very easy to clean.

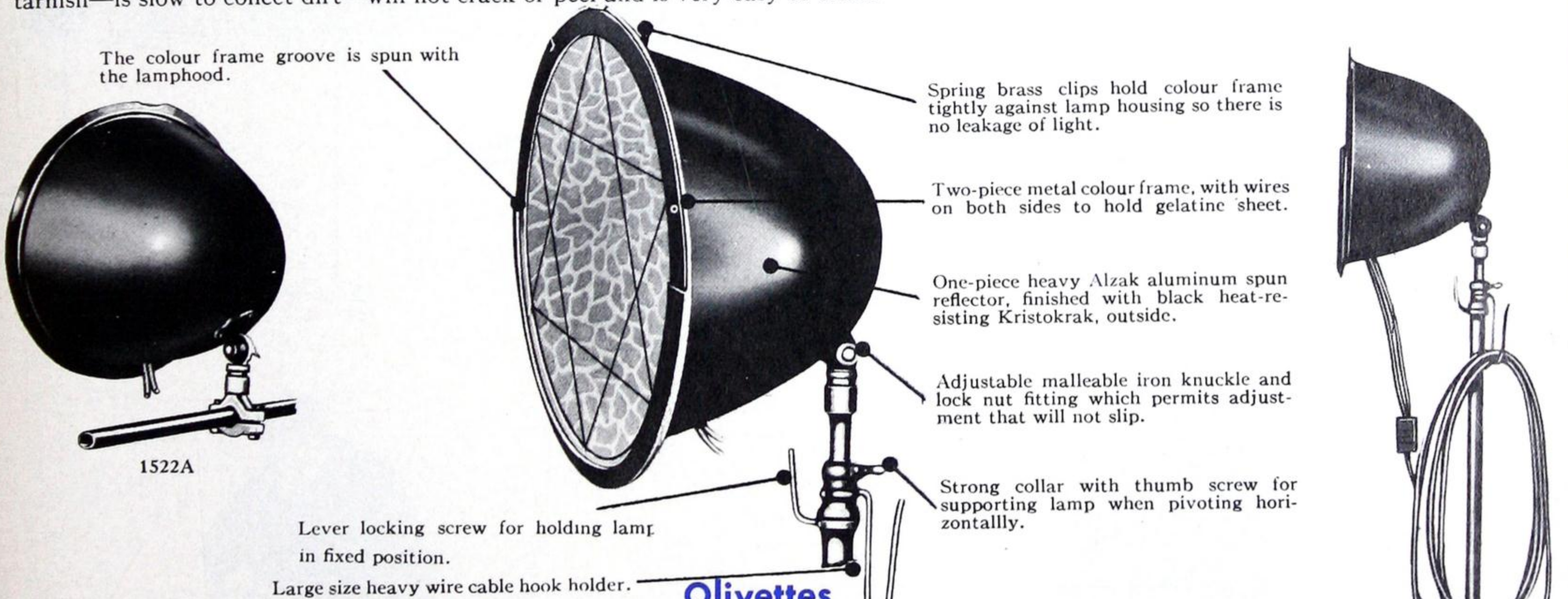

Olivettes

Use 750W, 1000W, or 1500W PS52 Lamp

Cat. No.	Accessories	Cable	Colour Frames Supplied (No Gelatine)	Shipping Weight
1520 A	Furnished with adjustable stand, 18'' diam. cast iron base.	25' No. 14 stage cable and slip connector	1 (No. 21A)	50 lbs.
1521 A	Knuckle joint only	3' Asbestos cord	1 (No. 21A)	32 lbs.
1522 A	Pipe clamp-heavy duty 1''-2''	2' Asbestos cord	1 (No. 21A)	35 lbs.

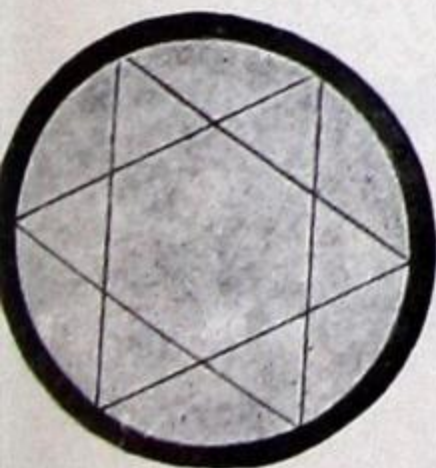

21A

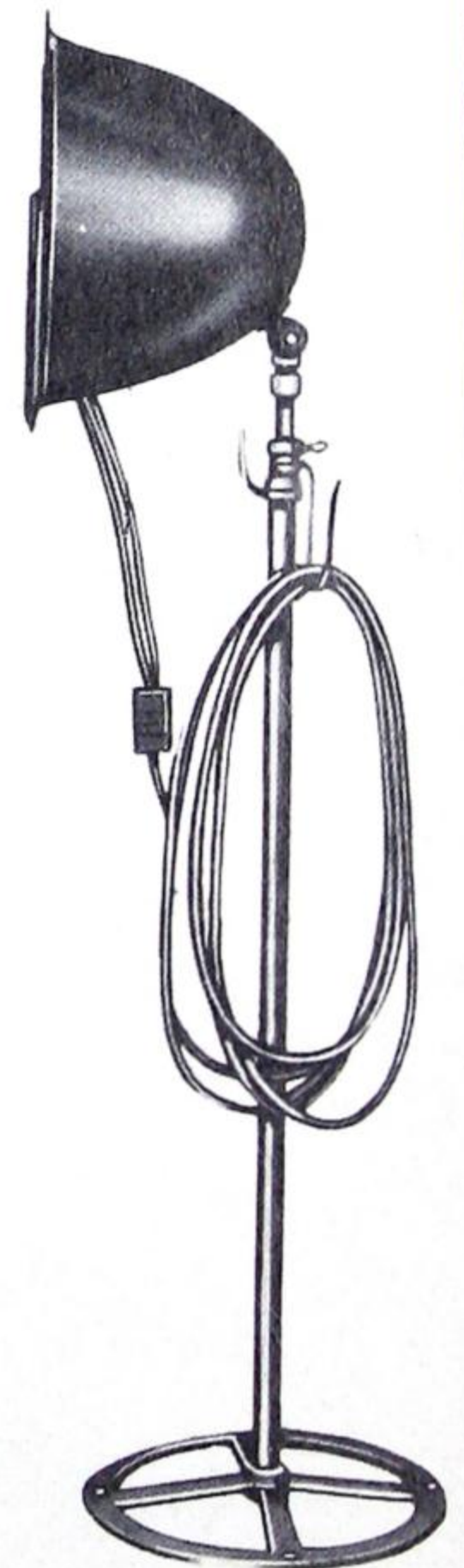

1520A



FOOTLIGHTS

Disappearing Footlights

The problem of footlights for stages that are used a part of the time for lectures, gymnasium exhibits, and concerts, is most practically answered by this line of Disappearing Footlights. Made in four types to suit most stage requirements.

The popularity of Disappearing Footlights attests to their efficiency, practicability, and adaptability for all small stages. Built in five-foot sections, each complete and wired ready for connecting, this unit is a wonderfully useful footlight for Schools, Colleges, Masonic and other fraternal auditoriums, and all manner of installations where the stage is used, part of the time for theatricals and part of the time as a lecture platform. The appreciation of the low cost of installing these footlight sections is part of their unmatched quality and design.

For general purposes the type D-156 is recommended as it has been found to apply to most conditions. The other types in the unit reflector group are sometimes selected for specific reasons, one having a smaller group of single row lights and the other two row facilities. The bare lamp type is offered to meet a demand for small installations, and requires the dipping of lamps or natural coloured lamps to obtain colour effects. The units are simple and "fool-proof", easy to specify, easy to install and easy to use.

These Footlights have a new, unique method of retaining the advantage of permanently wired connections without the danger of lights burning after the footlight has been put away. The current is automatically cut off by a positive, durable disconnect.

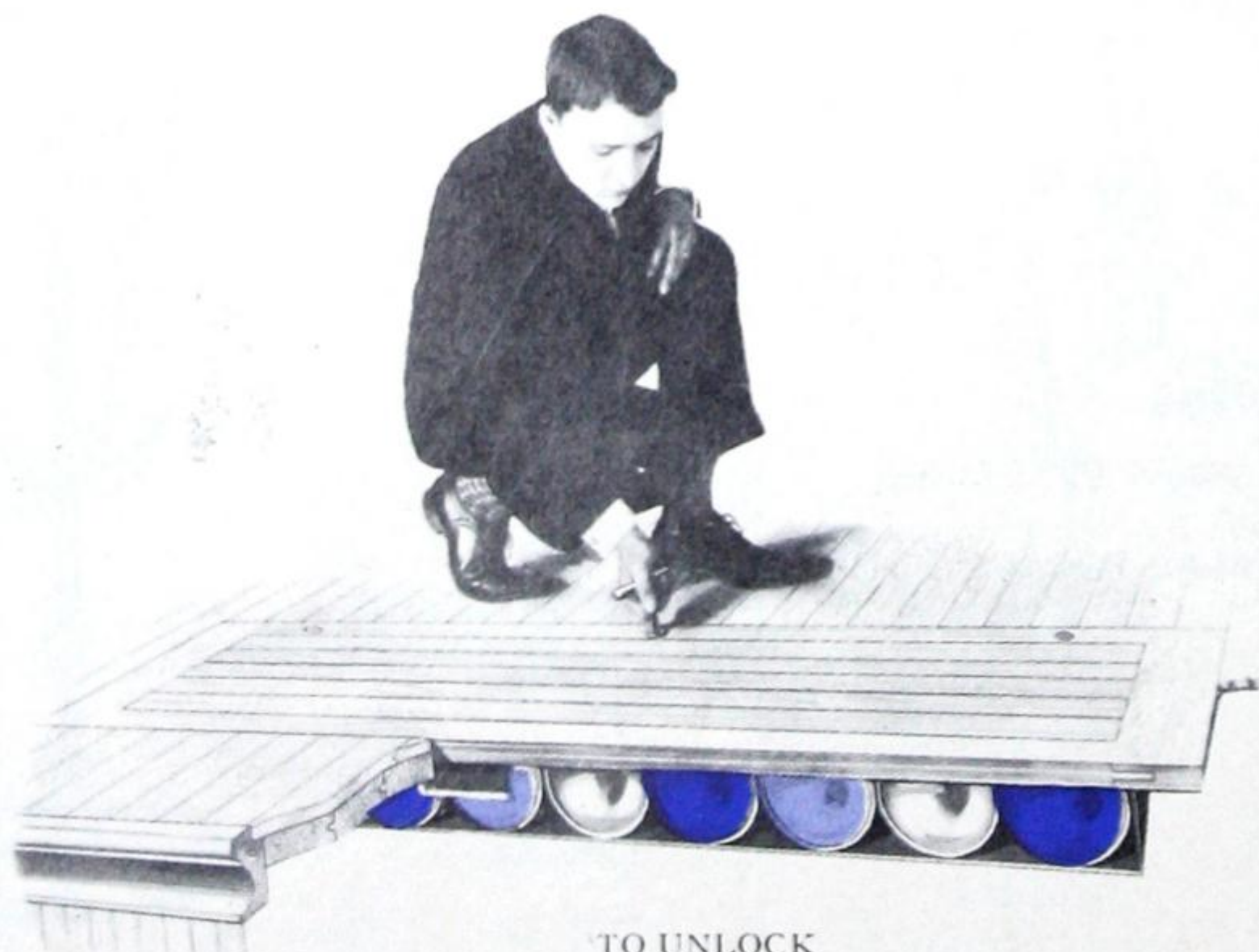
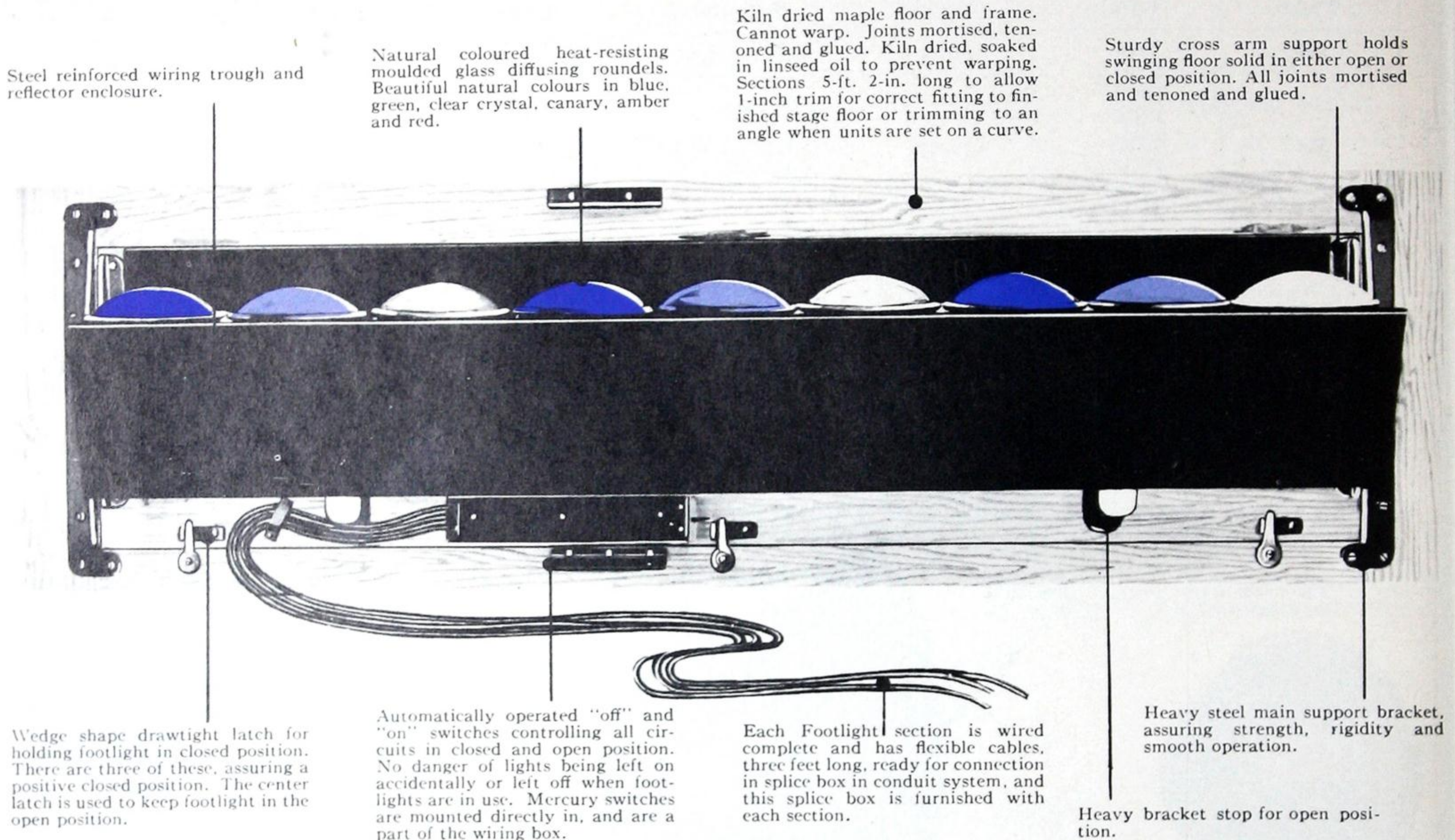

TO UNLOCK
A simple turn of three flush latches releases the footlight.

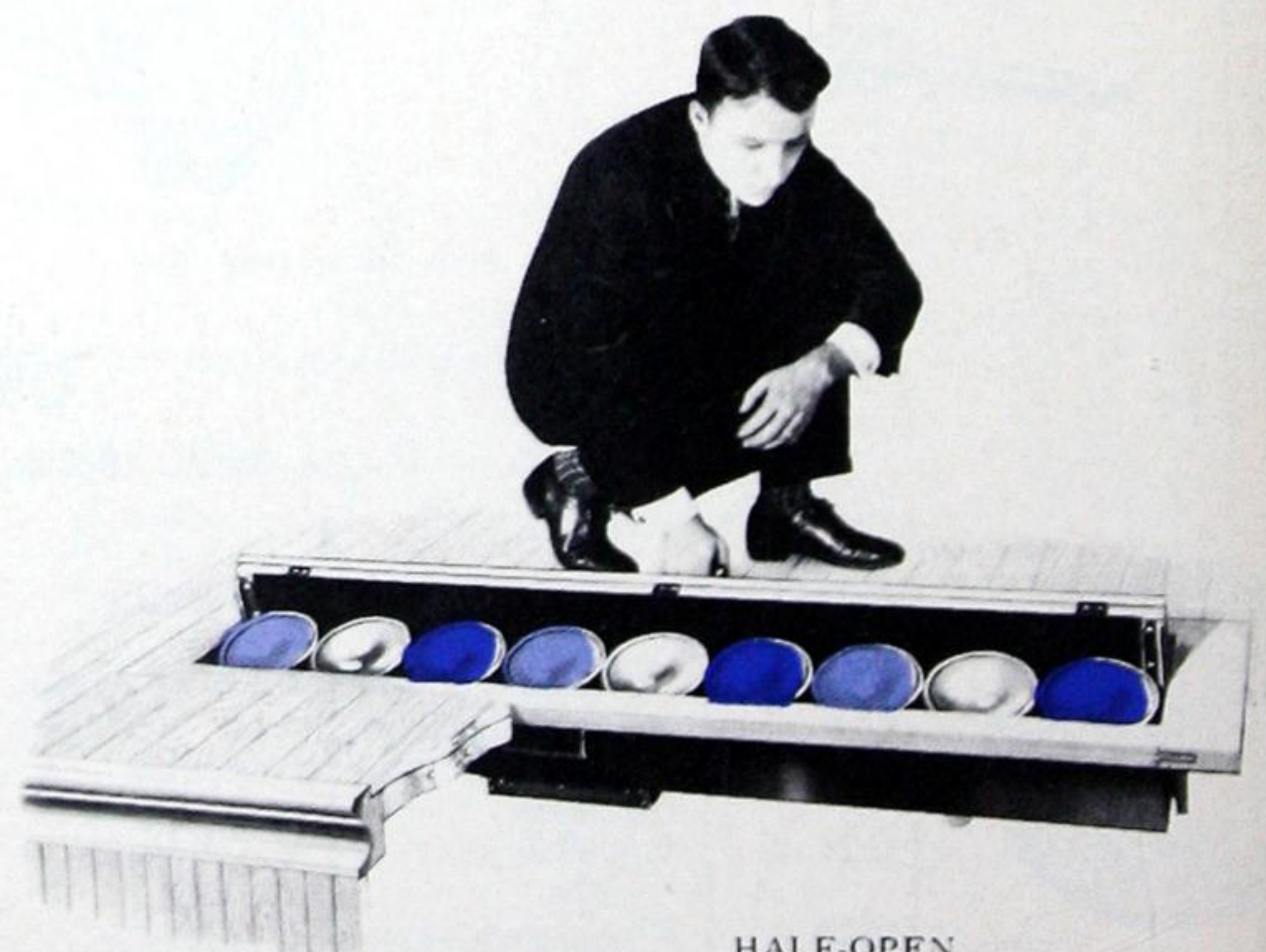

HALF-OPEN
Footlights automatically swing on a pivot to open position.



FOOTLIGHTS

Disappearing Footlights

ALL TYPES of disappearing footlights are made in 5 ft. Sections all include wiring, splice boxes for contractors conduit and circuit wiring, wood trim, wood swinging covers, wiring boxes, and all wiring for three colours and three conduits, ALTERNATELY; including mercury automatic disconnect switches for each circuit.

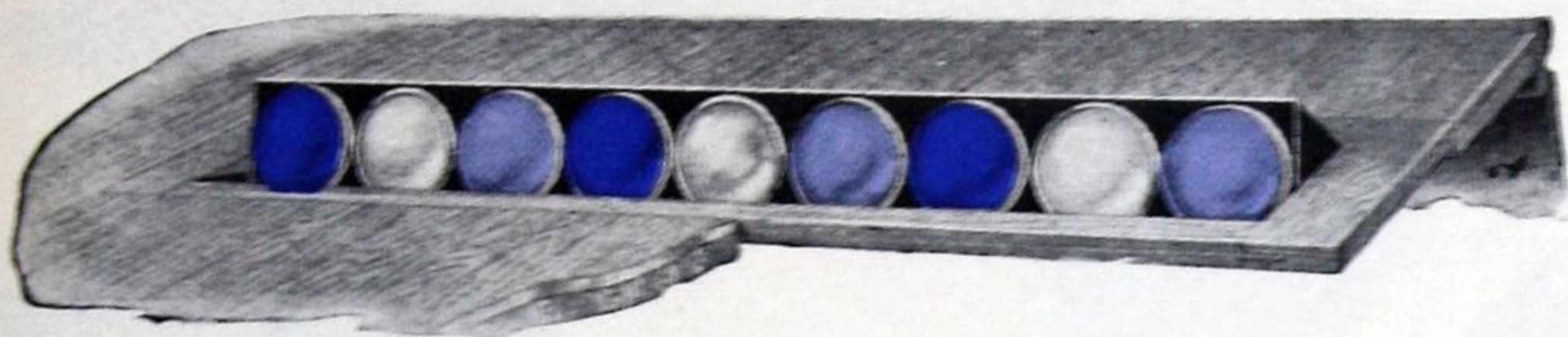

TYPES D-156, D-104



TYPE D-2R104



TYPE D-63-B

Type	Rows	Lamps	Each Section wired for	Includes	Shipping Weight
D-156	Single	150W PS 25	9-150W PS25 lamps	Clear or natural coloured roundels (Specify colours)	120 lbs./section
D-104	Single	60W-100W A-21	12-60 or 100W A21 lamps	(Specify colours)	120 lbs./section
D-2R104	Double	60W-100W A-21	24-60 or 100W A21 lamps	(Specify colours)	130 lbs./section
D-63-B	Single	60W-100W A-21	*15-60 or 100W A21 lamps	(Bare lamp unit)	110 lbs./section

* Standard is 15 sockets per section, but 12 or 18 sockets per section will be furnished if specified. All units wired for colours and circuits as specified.



FOOTLIGHTS

Surface Footlights

The F2R-156 double row unit reflector footlight has been proved as the best design for maximum wattage and minimum spacing. A flood of light is projected backward and upward, the lower row lighting the faces of those standing close to the front of the stage, even those who stand almost in the trough, and the upper row casting a volume of light directly toward the rear wall on the stage level, illuminating the feet. These two rows of projected rays overlap each other, so that an even field of light over the entire area is obtained. The top of this modern footlight is only three inches above the stage floor, a factor that is an advantage in calculating the sight lines of the theater. The F-156 and F-106 single row unit reflector footlights meet the requirements of the average stage and provide volume and spread of light, clearance of sight lines, sturdy construction and ease of maintenance. Colour roundels may be easily and speedily changed to meet the requirements of each production. While the volume of light is not as great as with the larger units, the individual reflectors allow maximum effect of the wattage used.

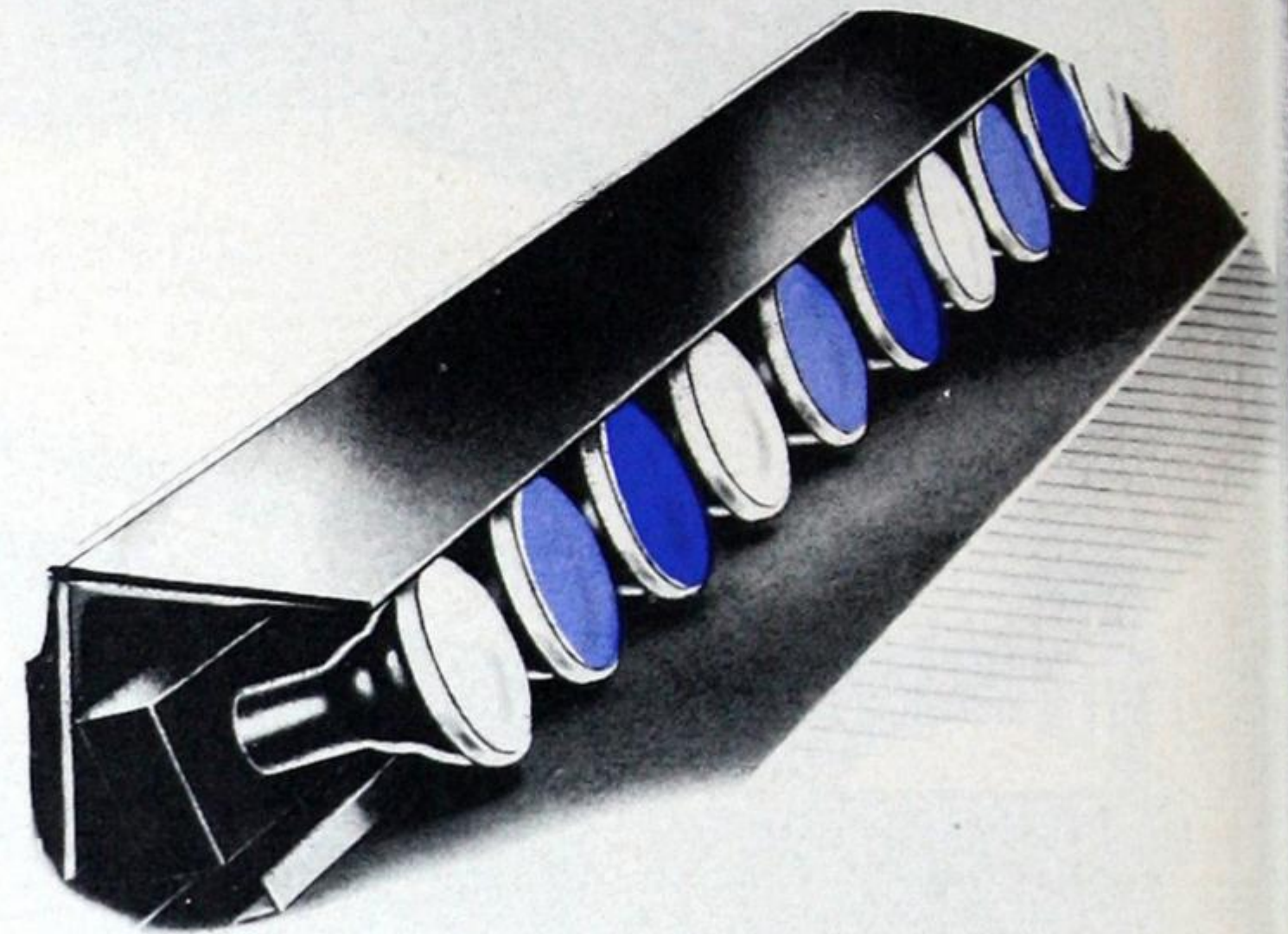
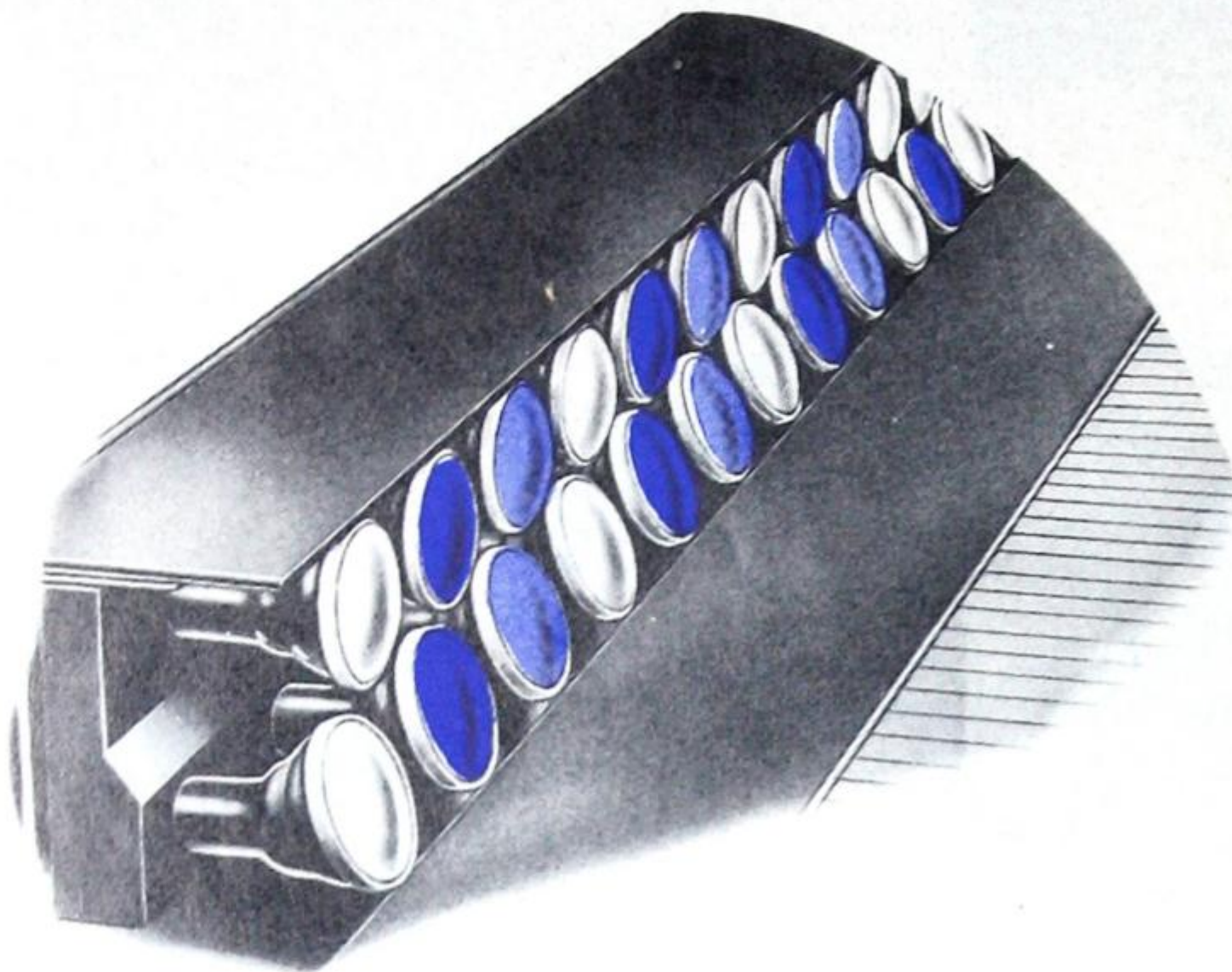

Type	Rows	Lamps	Centers	Includes	Shipping Weight
F2R-156	Double	150W PS-25	6"	Wiring box and clear or natural coloured roundels (Specify colours)	20 lbs./ft.
F-156	Single	150W PS-25	6"		15 lbs./ft.
F-106	Single	60W or 100W A-21	6"		15 lbs./ft.

Surface footlights of curved construction made to customer's specification. Special receptacle (for Baby Spotlight) wired on separate circuit if specified. Clear or natural coloured blue-red-amber-green and canary roundels available. All units wired for colours and circuits as specified.

Full size blueprint for plans or installation will be furnished upon request. All dimensions and information are given for the most practical and efficient construction.

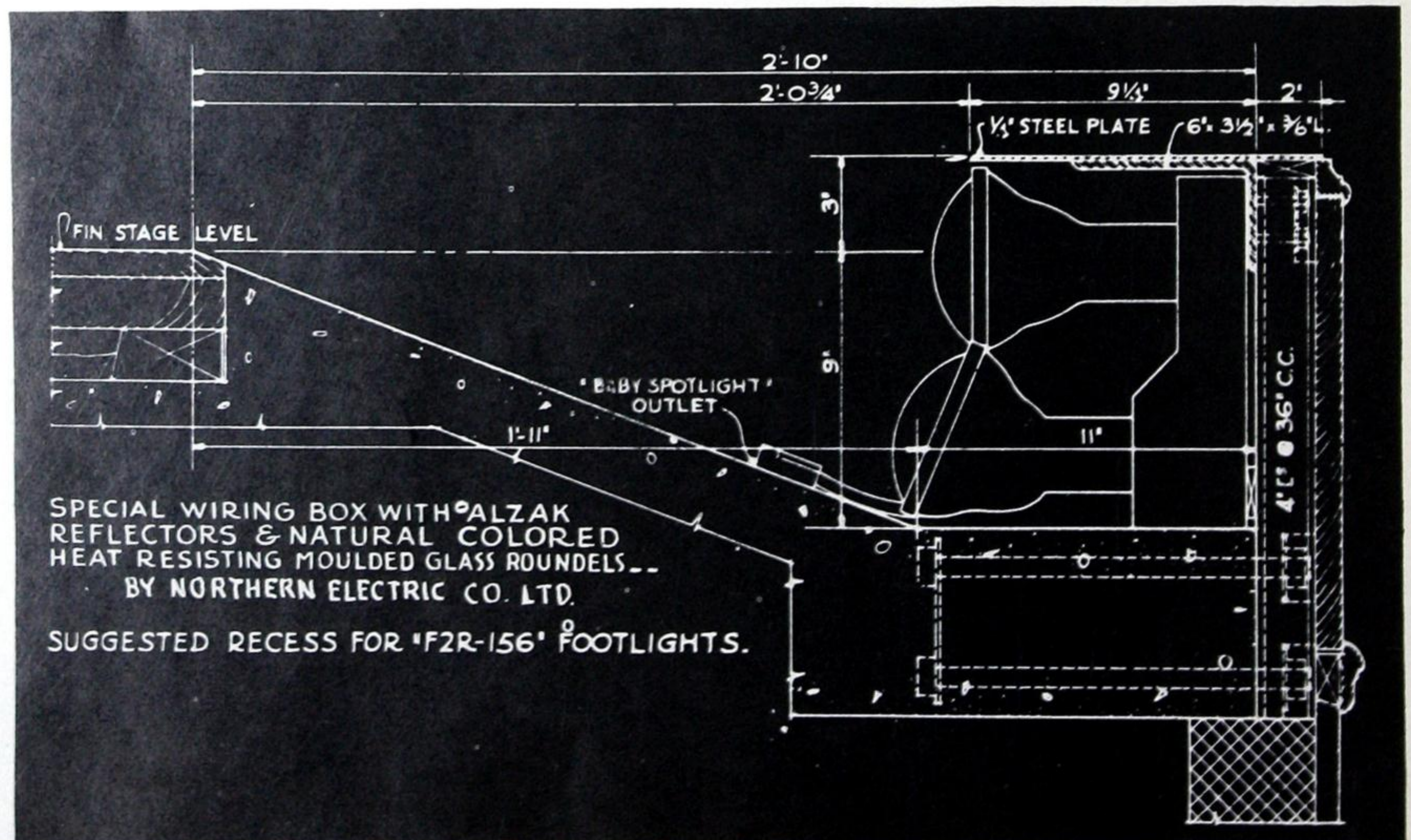



STAGE POCKETS

STAGE FLOOR POCKETS have self-closing flush door with safety tread surface, moulded heavy duty receptacle, cable slots that permit cover to close tightly whether in use or not, entire assemblage can be lifted out as one unit. Two 3/4" and two 1" knockouts are provided on each side so that conduit can enter or leave box from any direction.

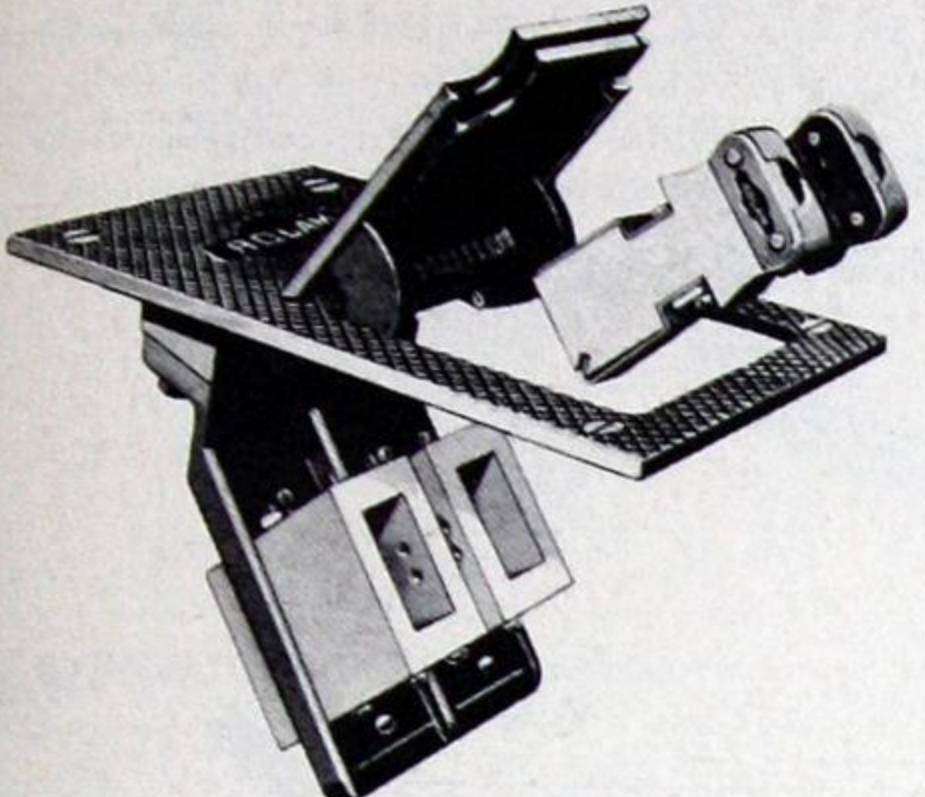

100 AMPERE CAPACITY

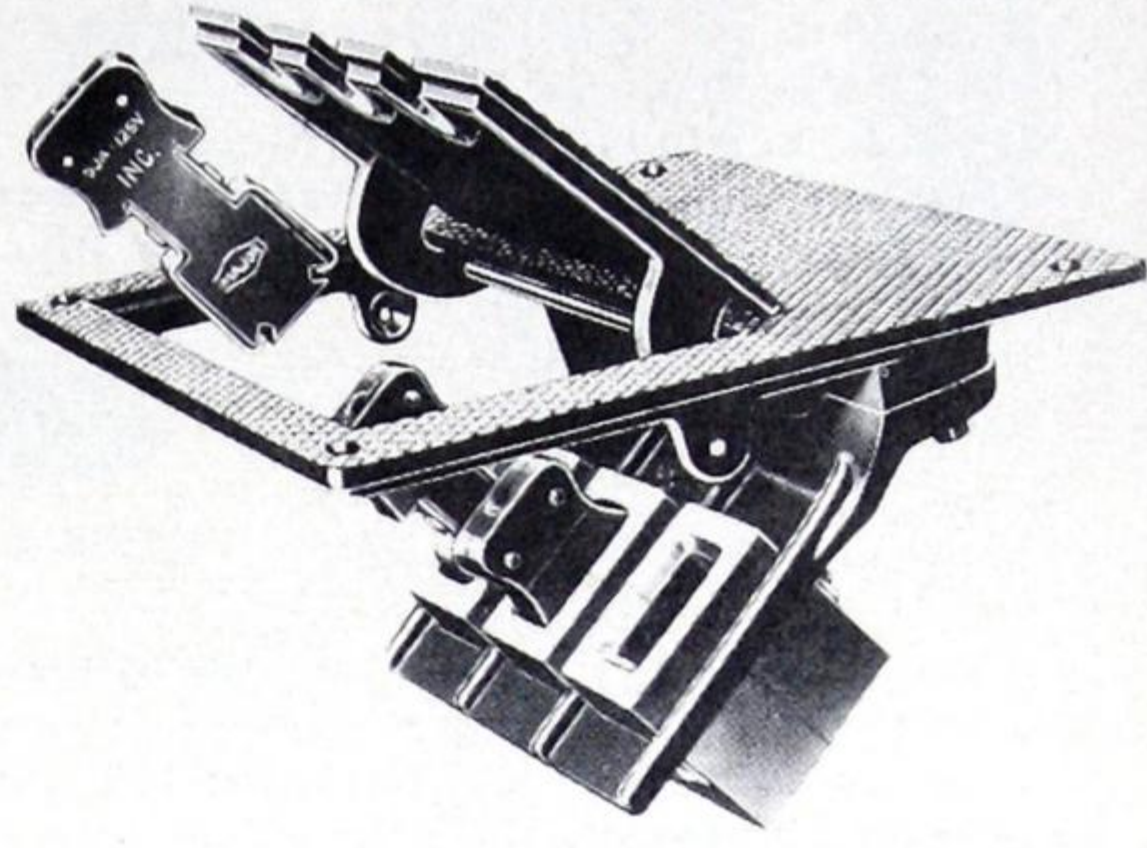
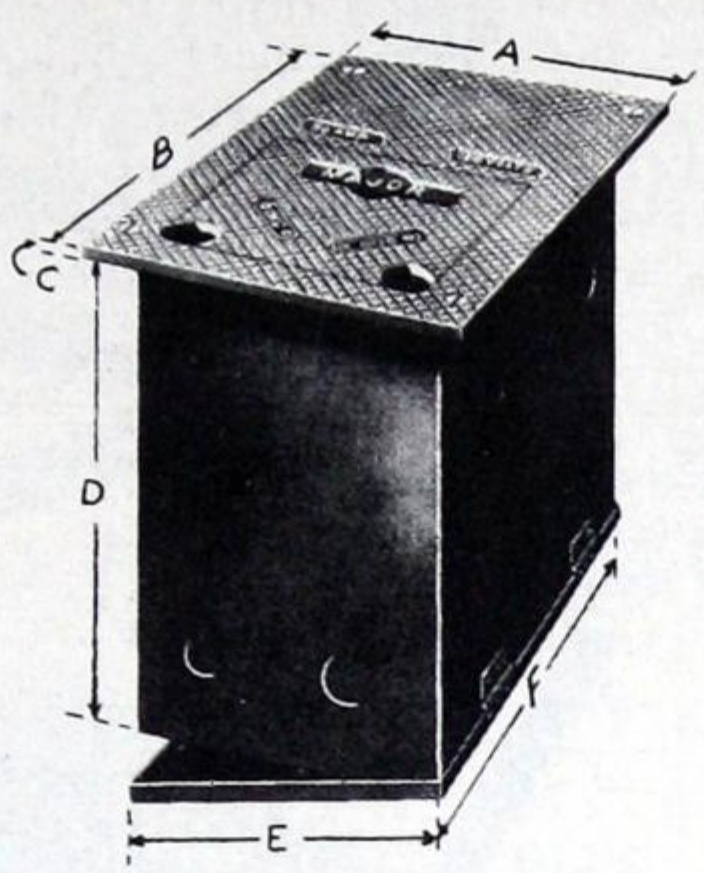

50 AMPERE CAPACITY

Stage Floor Pockets

Cat.* No.	Amp. Cap.	Gang	Plugs Supplied	DIMENSIONS						Shipping Weight
				A	B	C	D	E	F	
FF101	100	1	1	8 1/4"	11 3/4"	5/16"	10 3/4"	6 5/8"	10 1/4"	34 lbs.
FF102	100	2	2	13 3/4"	11 3/4"	5/16"	10 3/4"	12 1/4"	10 1/4"	39 lbs.
FF51	50	1	1	6 3/4"	11 3/4"	5/16"	10 3/4"	5 1/4"	10 1/4"	32 lbs.
FF52	50	2	2	8 1/4"	11 3/4"	5/16"	10 3/4"	6 5/8"	10 1/4"	34 lbs.
FF53	50	3	3	13 3/4"	11 3/4"	5/16"	10 3/4"	12 1/4"	10 1/4"	37 lbs.
FF54	50	4	4	13 3/4"	11 3/4"	5/16"	10 3/4"	12 1/4"	10 1/4"	39 lbs.
FF55	50	5	5	16 1/2"	11 3/4"	5/16"	10 3/4"	16 3/8"	10 3/4"	42 lbs.

Two 3/4" and two 1" knockouts are provided on each side of box.

*JEWEL INDICATORS: supplied if specified—These indicators operated by a mercury switch connected to the hinged lid identify colour circuits and provide sufficient light for easy location of stage plug-in socket.

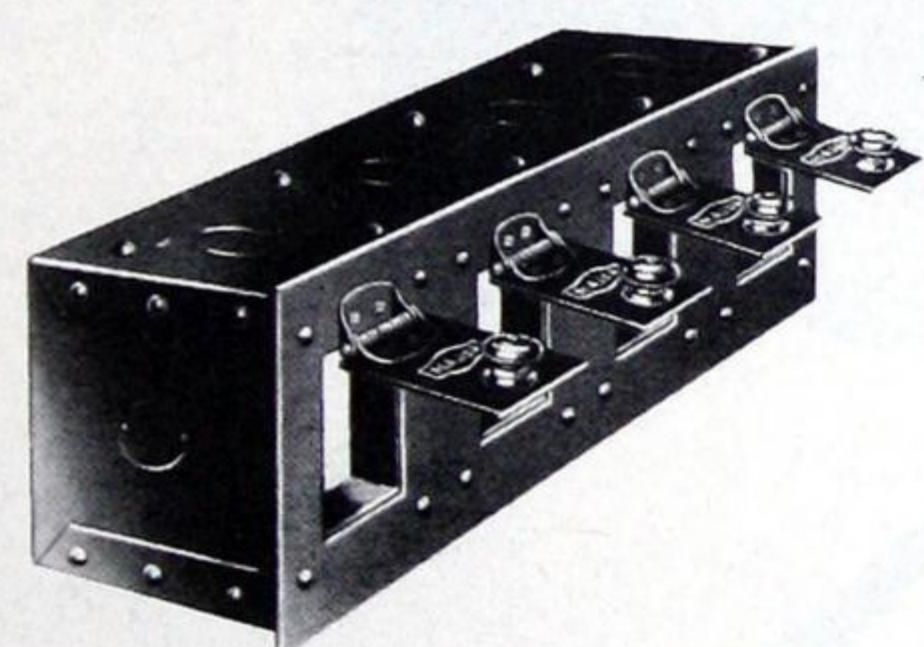

Stage Wall Pockets

For use in back-stage walls, moving picture booths, fly floors and wherever FLUSH or SURFACE Mounting Wall Pockets are convenient and desirable—MAJOR offers this excellent group. Strength, light-weight and compactness have been paramount in the design of this equipment. Can be furnished with or without lock and key.

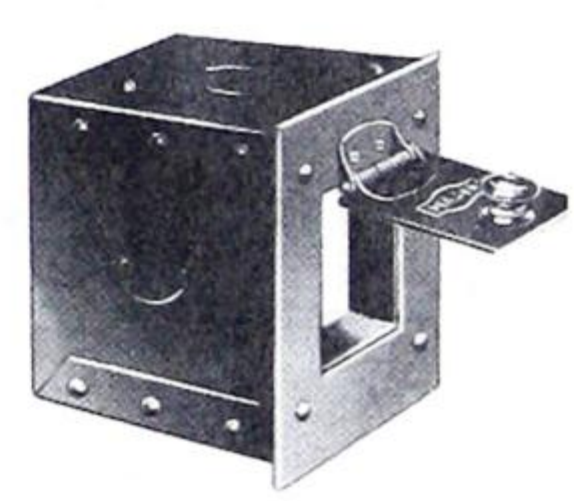

STAGE WALL POCKETS

Cat.* No.	Amp. Cap.	Type Mounting	Gang	Plugs Supplied	DIMENSIONS					Shipping Weight
					A	B	C	D	E	
FW101	100	Flush	1	1	10"	7 1/4"	5 1/4"	11 1/2"	8 3/4"	10 1/2 lbs.
FW102	100	Flush	2	2	18"	7 1/4"	5 1/4"	19 3/4"	8 3/4"	17 lbs.
SW101	100	Surface	1	1	10"	7 1/4"	5 1/4"	11 1/2"	8 3/4"	10 1/2 lbs.
SW102	100	Surface	2	2	18"	7 1/4"	5 1/4"	19 3/4"	8 3/4"	17 lbs.
FW51	50	Flush	1	1	6 1/4"	6 1/4"	5 1/4"	7"	7"	6 1/2 lbs.
FW52	50	Flush	2	2	10"	7 1/4"	5 1/4"	11 1/2"	8 3/4"	10 1/2 lbs.
FW53	50	Flush	3	3	14 1/2"	7 1/4"	5 1/4"	15 7/8"	8 3/4"	13 1/4 lbs.
FW54	50	Flush	4	4	18"	7 1/4"	5 1/4"	19 3/4"	8 3/4"	17 lbs.
FW55	50	Flush	5	5	21 5/8"	7 1/4"	5 1/4"	23 3/8"	8 3/4"	23 lbs.
SW51	50	Surface	1	1	6 1/4"	6 1/4"	5 1/4"	7"	7"	6 1/2 lbs.
SW52	50	Surface	2	2	10"	7 1/4"	5 1/4"	11 1/2"	8 3/4"	10 1/2 lbs.
SW53	50	Surface	3	3	14 1/2"	7 1/4"	5 1/4"	15 7/8"	8 3/4"	13 1/4 lbs.
SW54	50	Surface	4	4	18"	7 1/4"	5 1/4"	19 3/4"	8 3/4"	17 lbs.
SW55	50	Surface	5	5	21 5/8"	7 1/4"	5 1/4"	23 3/8"	8 3/4"	23 lbs.

Cover lock and keys available for each opening if specified.

*JEWEL INDICATORS: supplied if specified—These indicators operated by a Mercury switch connected to the hinged lid identify colour circuits and provide sufficient light for easy location of stage plug-in socket.



SPOTFLOOD UNIT

Experience and engineering combined with modern plant equipment classes this unit as best in quality and manufacture at a practical price for its many uses. ALZAK is used for the reflector—delivering the most efficient light for each light dollar. The reflector is Specular Finish and with a 500 W. or 1000 W. floodlight lamp has a 60 ft. throw. Where a wider spread is desired—a Diffused Finish reflector is furnished if specified. Clips and clamps have been attached so that changing of colour frames or relamping is done with a minimum of effort and delay. Spotflood is supplied wired, with stand, and colour frame. Extra colour frames, Cat. No. BCF-12, available if specified.

NOTE: The Spotflood Unit utilizes either of two standard floodlight lamps, a G-16, 1000 W. Mogul Screw base, Clear Flood with a 5 1/4" L. C. L. or a G-40, 500 W. Mogul Screw base, Clear Flood with a 4 1/4" L. C. L. Customers MUST specify which lamp will be used so that correct focus may be factory set between lamp filament and reflector focal point. Users may—in the field—readjust the screws in the focusing adjustment slot to change from a 500 W. to a 1000 W. or vice versa.

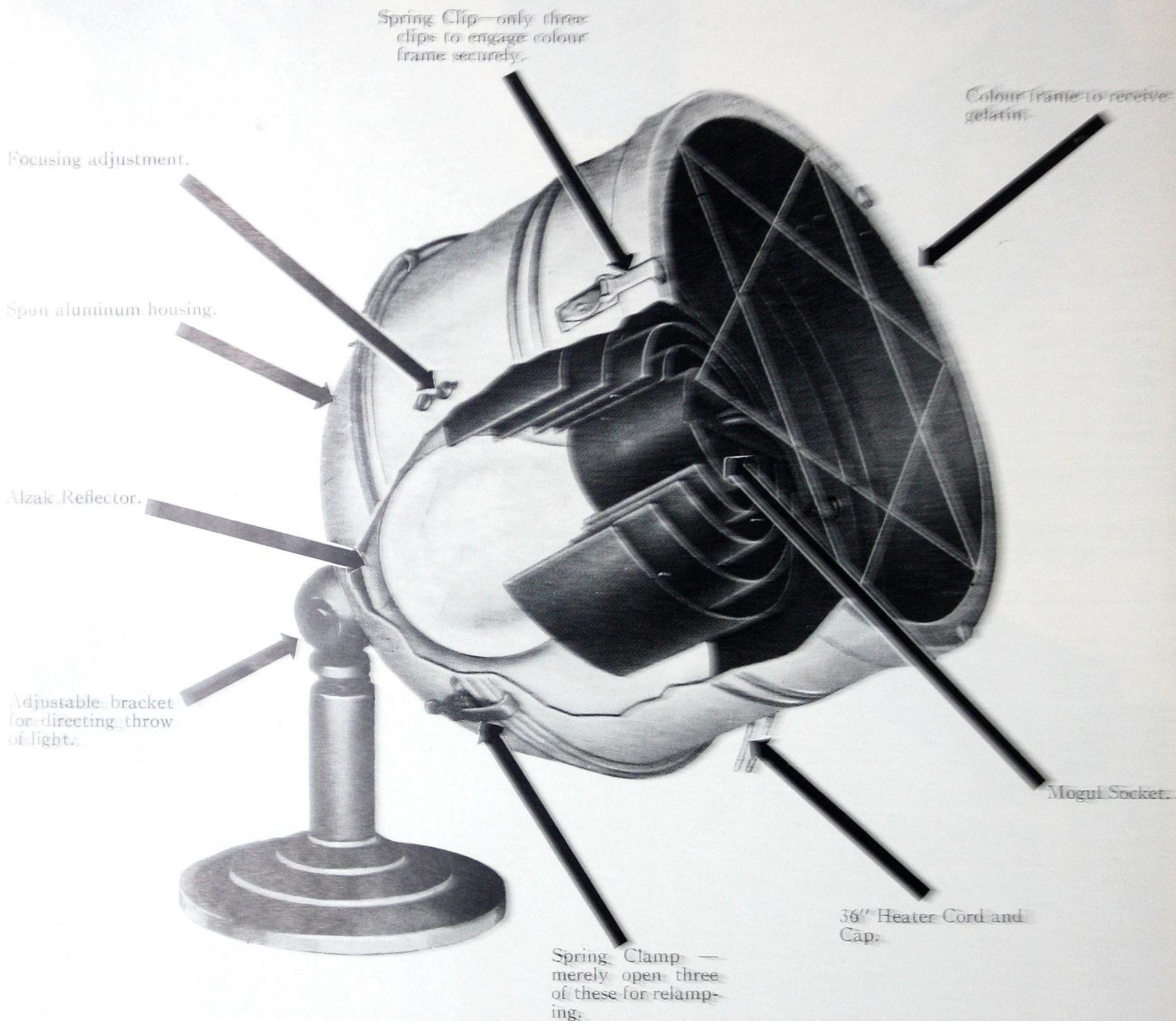

CAT. No. 1SF-1050

Cat. No.	Lamp Watts*	Wired	Colour Frames Supplied	Cat. No.—Extra Colour Frames
1SF-1050	500 or 1000	36" Heater Cord	1	BCF-12

*—Specify wattage of lamp to be used.



ACCESSORIES

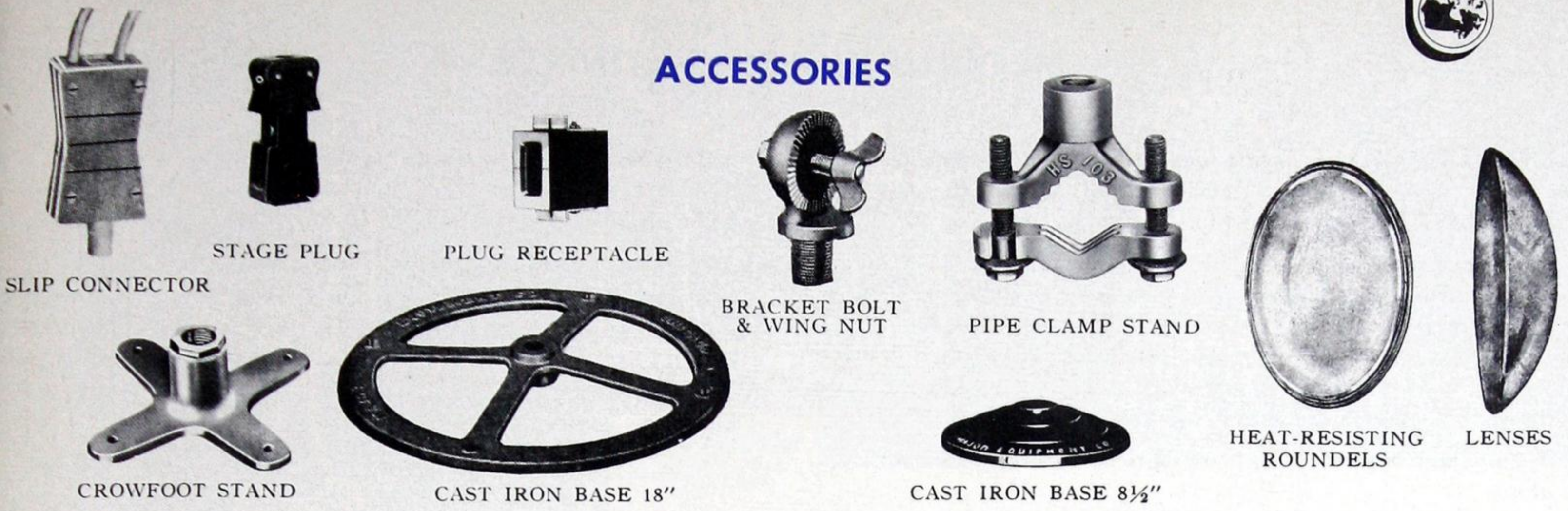

Cat. No.	Description	Use
21	2-piece 15 amp. slip connector	General purpose
800	50 amp. stage plug	For use with stage pockets
900	100 amp. stage plug	For use with stage pockets
50	50 amp 120V. Plug receptacle	Replacement parts for stage pockets-special units
6F	Bracket bolt and wing nut	All purpose — threaded to fit 1/2" standard pipe fittings
32	Light duty clamp stand	To support small units on pipe—clamp capacity 1" to 2"
64	Heavy duty clamp stand	To support heavy units on pipe—clamp capacity 1" to 2"

Cat. No.	Description	Use
10F	Aluminum crowfoot stand	General purpose
CIB-18	18" diam. cast iron base—tapped 1"	General purpose pipe base
10SB	8 1/2" diam. cast iron base—tapped 1/2"	General purpose pipe base
4L	Clear 4 1/2" standard spotlight lens	For 4 1/2" standard spotlight equipment.
6L	Clear 6" standard spotlight lens	For 6" standard spotlight equipment.
8L	Clear 8" standard spotlight lens	For 8" standard spotlight equipment
8PL	Clear 8" heat-resisting Pyrex spotlight lens	For use in 8" lens spotlights when 1500W or 2000W lamps are used.

Colour Roundels

Colours *	Clear	Red	Blue	Yellow	Amber	Green	Revelation **
Diam.	Cat. No.	For units as listed					
3 3/4"	375	Footlights D-104, D-2R104					
5 5/8"	558	Borderlights B-156, B-106, Footlights D-156, F2R-156, F-156, F-106					
7 9/16"	758	Borderlights B-208					
11 1/4"	1125	Box Lights 351, 350, Borderlights B-512					
15 3/4"	1575	Box Lights 6101, 6100					

* Diffusing only — specify colour i.e. 375 clear, 558 red, etc.

** Revelation Roundels are manufactured from a special glass which affords a far more natural rendition of the colours of costumes and scenery than is possible with any standard clear glass roundel.

Multiple Mounting

The desire for a great flood of light from the first entrances has called for a multiple mounting bracket as shown below. This not only fulfils the proscenium entrance requirements but has many other uses for spotlight mounting.

The illustration shows how compactly six spotlights can be mounted clear of the floor and close against the wall. This multiple mounting bracket is also used on portable stage and hanging bridges. These are spotlights with 8" lenses, yet the outside handle is only 21" from the proscenium wall and all six are mounted in a vertical distance of seven feet.

Batten Boxes

For current supply to spotlight or Olivette hung on the pipe batten. This batten box has been found most practical. It clamps directly to the pipe batten, extending the entire length, and all wiring is enclosed. 18" of super-service cord leads equipped with 15 ampere slip connectors are spaced approximately every eighteen inches. This new Batten Box can be used on swinging bridges with equal facility, and does away with all long runs of cables that are both dangerous and expensive.

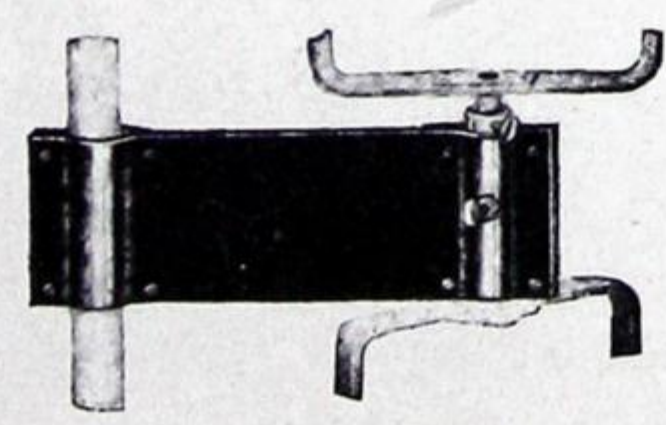
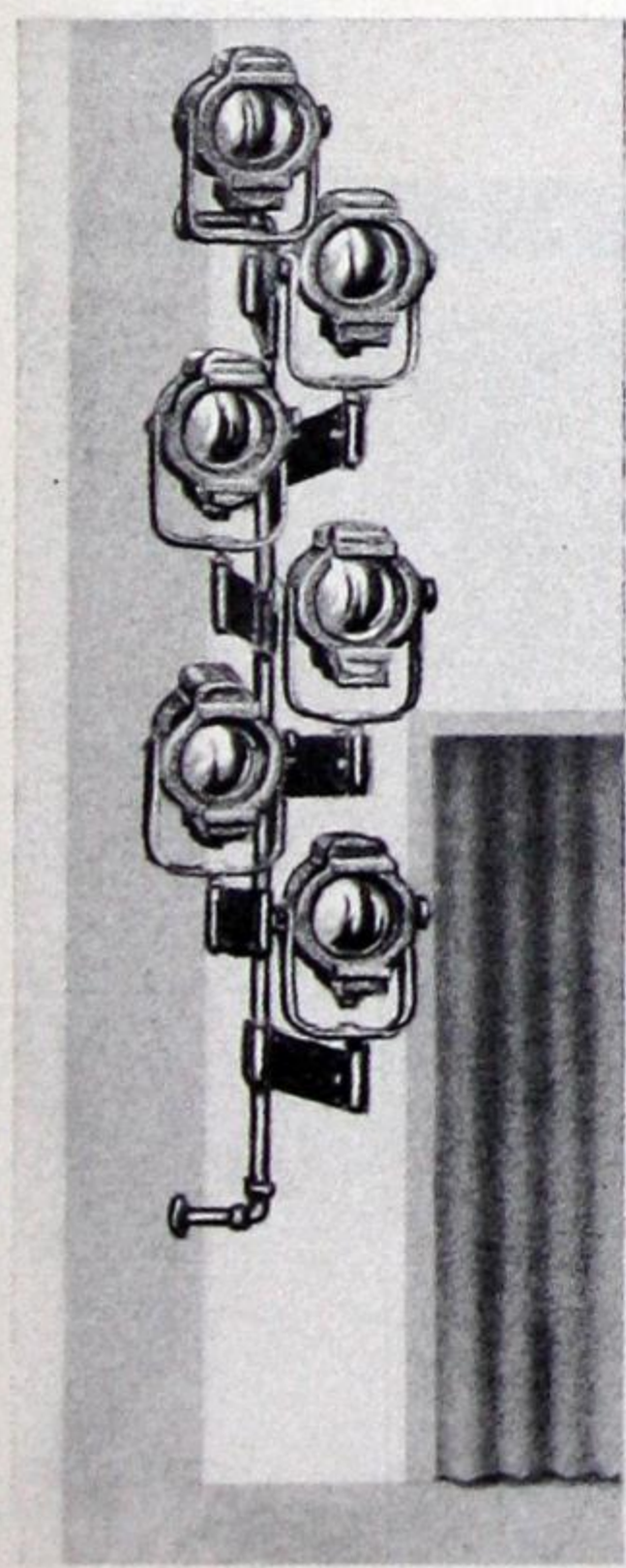

No. M.M.

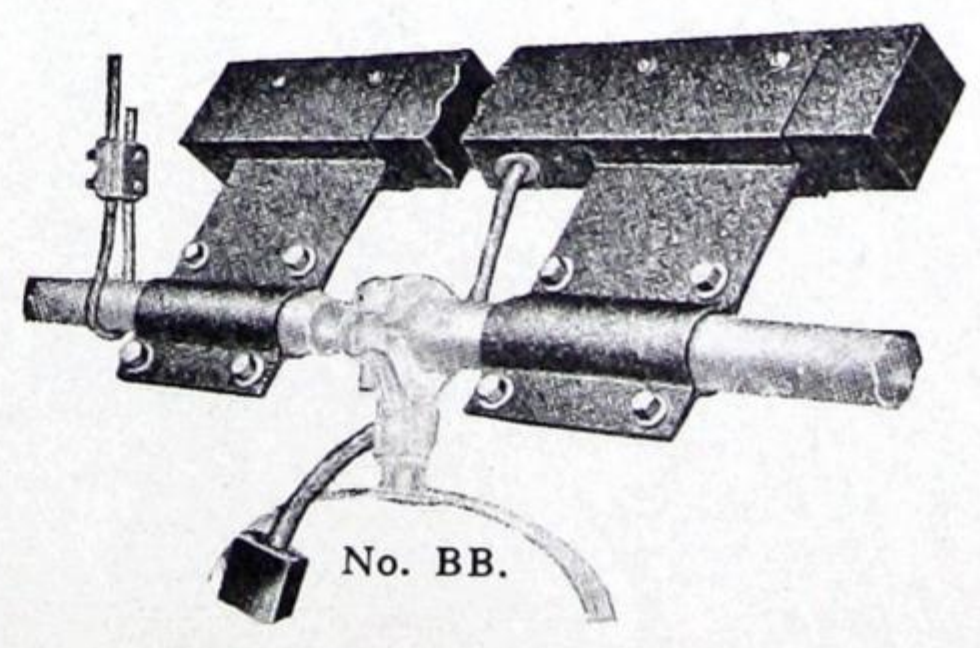

No. BB.



MODULITE LIGHTING CONTROL

The "Modulite" Lighting Control System provides safe, flexible, efficient, easy to operate Illumination Control for theatres, auditoriums, schools and fraternal buildings, etc.

The "Modulite" method provides pre-selective remote dimming of the single pre-set type, whereby the intensity of each Dimmer Control unit may be pre-set for any desired lighting effect. This means that guess work has been eliminated from stage lighting . . . it is now possible to reproduce exactly at anytime, or any number of times, a predetermined Lighting effect.

A complete lighting control system consists of two principal units—

- (a) A Dimmer Switchboard containing all main and branch circuit breakers, dimmers, etc. (All dimmers used are Major-Cutler-Hammer individually motor operated, 4KW auto transformer type dimmers.)
- (b) A Control Board having mounted thereon all individual and master dimmer controls, all individual and master contactor controls, with indicating lights located adjacent to their associate controls and with proper identification of the controls, etc.

Both boards are supplied complete with all internal wiring.

The "Modulite" control system may be designed to suit the requirements of any stage:—

CONSULT YOUR LOCAL NORTHERN ELECTRIC OFFICE

Control Features

PRE-SETTING OF LIGHTS TO OBTAIN PRE-DETERMINED INTENSITIES: True Dimming with more than ample steps to assure flickerless proper and smooth control in all positions from full bright to blackout.

COMPACT: Elimination of ponderous gear, belt and chain drives by a special small type motor with built-in gear box, which is connected directly to the dimmer, coupled with a unique

method of electrical connections which reduces substantially the number of control wires required, plus other design refinements make the Modulite system the most compact yet developed.

SPACE SAVING: Valuable on-stage space is saved because only the small control board is placed here, either fixed on the wall, or portable to be plugged in wherever needed. The dimmer switchboard with its dimmer apparatus, motor drives, branch circuit breakers, etc., may be located at any other point in the building.

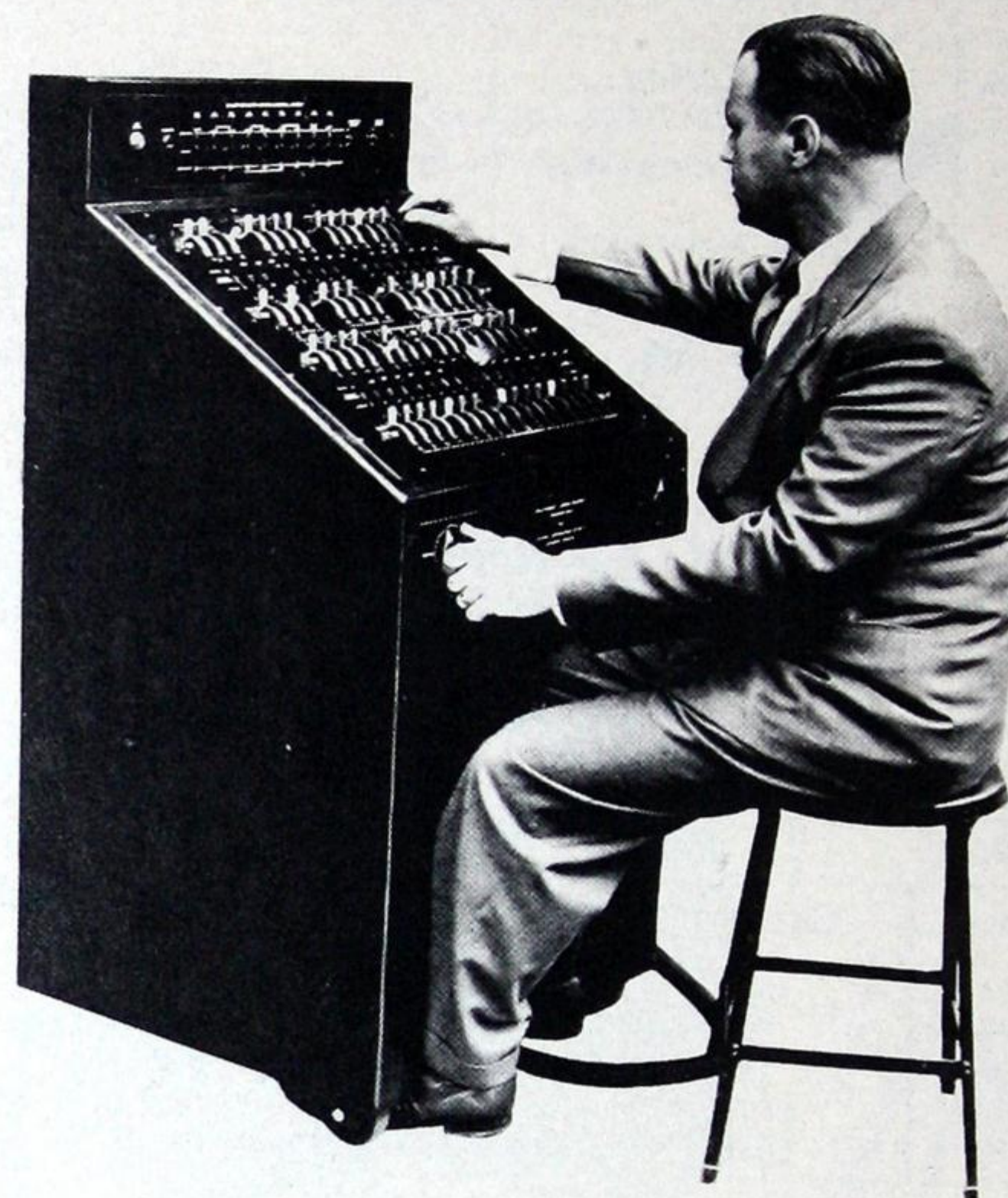

TYPICAL PORTABLE CONTROL BOARD

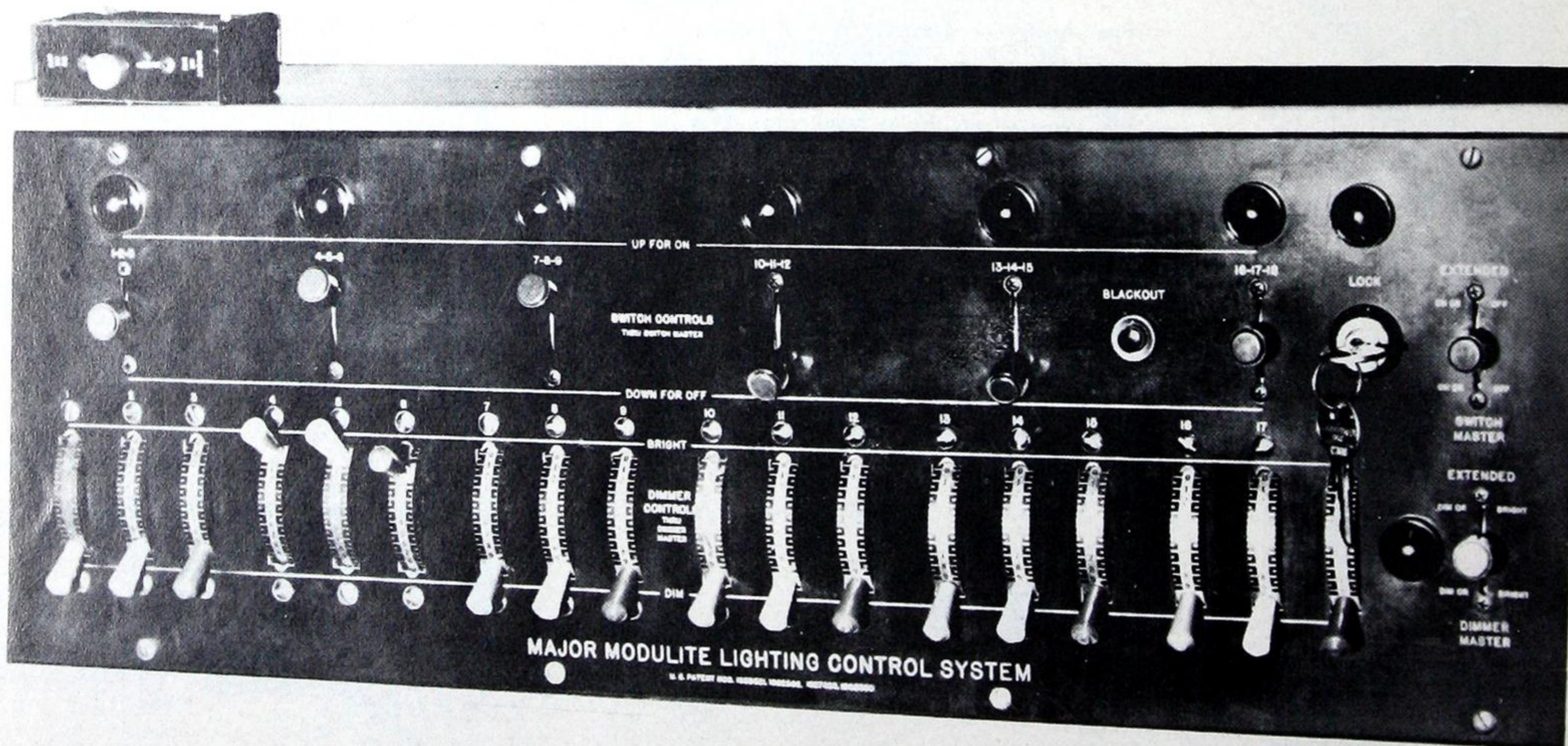

TYPICAL PERMANENT CONTROL BOARD

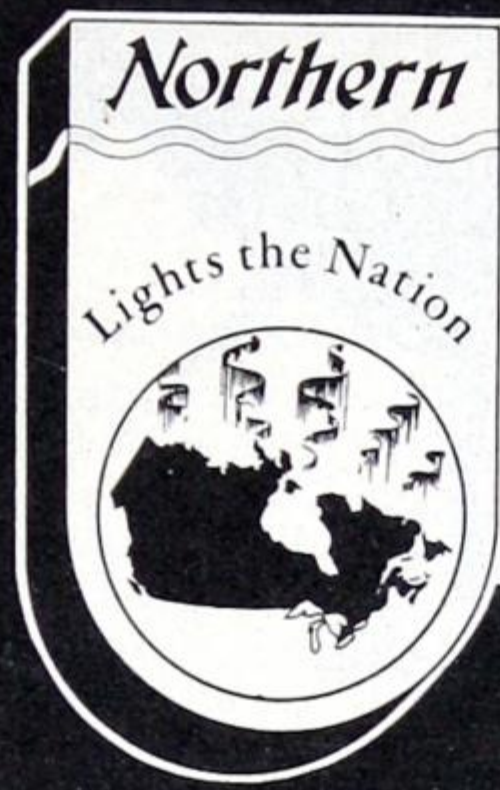
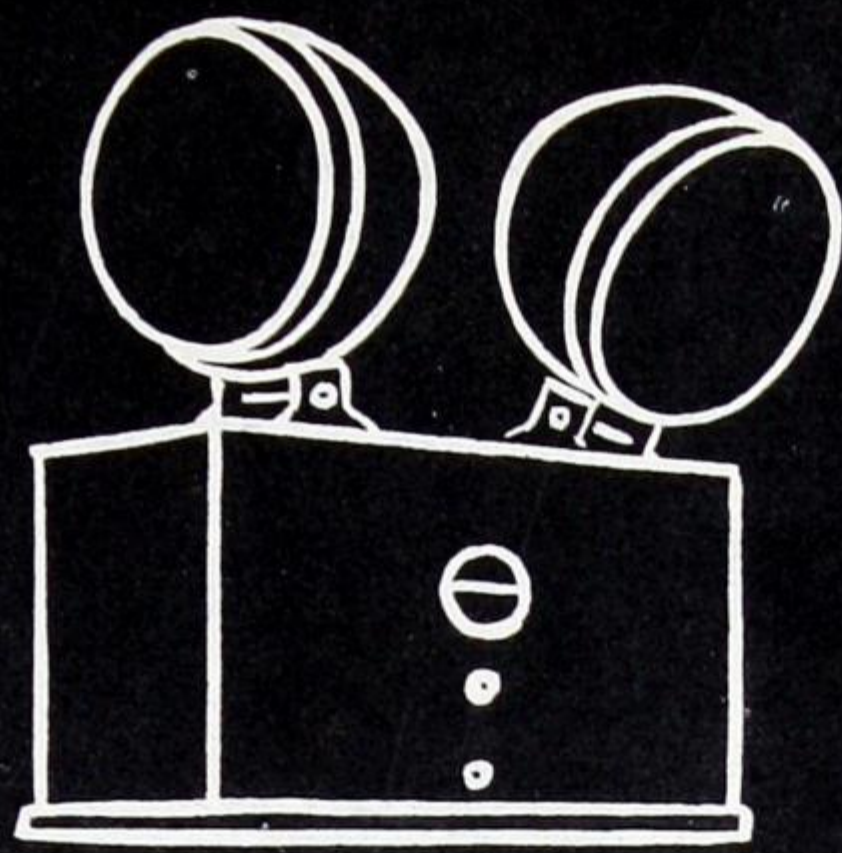
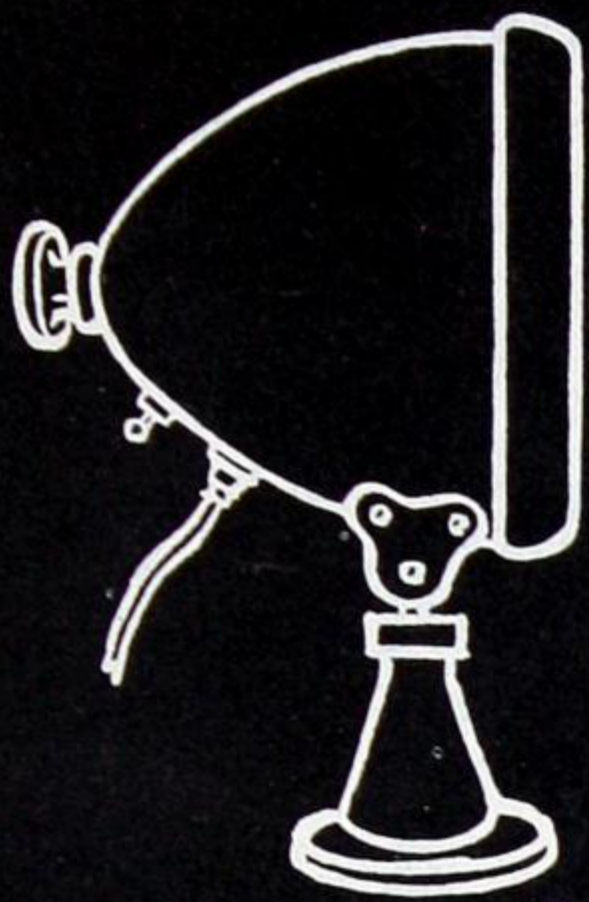

PORTABLE AND EMERGENCY LIGHTS

CONTENTS

Marine Searchlights	204
Emergency Lights	205
Portable Hand Lamps	206
Portable Searchlights	207
Battery Charger	208



Use the

Northern Electric Lighting Service



MARINE SEARCHLIGHTS AND PORTABLE STREET WARNING LIGHTS

A Complete and Dependable Line of Portable and Emergency Lights for Every Application to Provide Light WHERE You Need it WHEN You Need it

Marine Searchlights



TYPE 106

6" diameter housed reflector searchlight for small craft. Patented Pilot-House Instant Lever Master Control. Searchlight range: half mile.

This light is economical and one of the most popular marine lights. The Lever Master Control is a great improvement over any "push-and-pull" control type. Furnished in either full chromium or polished brass and bronze.

Height above deck: 11 1/2 inches. A No. 4524 6-volt sealed beam bulb is used with this light.

(Marine Searchlights also available for the following voltages:—6, 12, 24 to 32, and 110-120 volts)



TYPE 1028

8" diameter housed reflector searchlight for large craft. Searchlight range: one mile. Outside control from the deck with switch either on light or on instrument board. Height above deck: 14 1/2 inches. A No. C76 6-volt bayonet base super bulb is used with this light.

Super-bulbs with black caps are made according to exacting specifications ensuring longer battery burning hours, the greatest brilliancy and power of the searchlight beam and entirely doing away with light spillage on the deck that with all other bulbs partially blinds the pilot.



TYPE 1008

8" diameter housed reflector searchlight for larger craft. Patented Pilot-House instant one hand lever control. Searchlight range: one mile.

Light can be revolved in a complete circle at any angle up or down. Point the handle in desired direction. Switch in handle. Operates from boat's regular power line, or separate battery. Friction device holds the light in any position regardless of vibration. Special triple plated precision parabolic reflector projects a one-mile beam of maximum brilliancy. Well constructed brass and bronze castings and stampings throughout, heavily chromium plated—or full polished brass and bronze. Rustproof, Weatherproof. Height above deck: 15 1/2 inches. No. C76 6-volt bayonet base super bulb.

Portable Street Warning Lights

A remarkable neon red flashing 120 day light. For use as a temporary or permanent traffic signal, and for many other uses. Requires only one set of batteries inside base for months of colored light, flashing 60 to 120 times a minute, 24 hours a day. May be mounted on a pedestal or elsewhere as needed. Remarkable savings as high as 75% in electric current alone are reported in comparison with street traffic lights wired to outside current. Good for years of dependable service. Cast aluminum base... rugged and durable. Also available in corrosion-proof finish for marine use. Battery included.



NRF

BATTERY — Carpenter F-5 7 1/2-volt. BULB—NRF Special. FLASHER—NRF Special. LENS—4 1/2"—specify color. SIZE—7" x 8" x 14" high.

WEIGHT—20 lbs.

Identical with NRF except 6' high. Visible over the tops of parked or approaching cars.

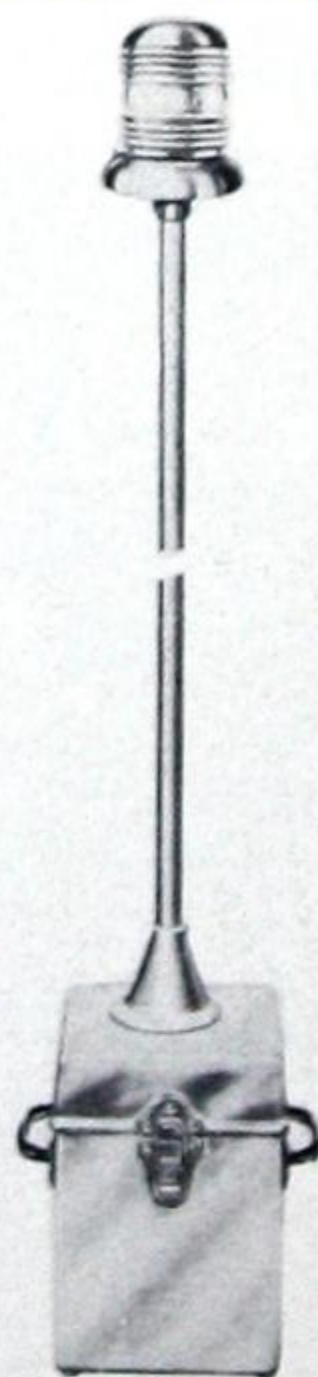

NRFX

Street or highway emergency signal. Excellent for fire hose protection, road accidents and other emergency uses. Will give 72 hours of continuous flashing light. Sturdy, compact and practical. Visible a mile or more in any direction. Protects men making emergency street repairs. Cast aluminum base. Clamps directly to battery. Housed-in flasher.

*BATTERY—Carpenter F-5 7 1/2-volt. BULB—Carpenter No. 64. LENS—3 1/4" Red Fresnel. SIZE—6 3/4" x 7" x 13" high.

FLASHER—611-D.

*Battery not included.

Available with light mounted on cast aluminum box for either dry battery or rechargeable battery operation.



RH-1



EMERGENCY LIGHTS

Emergency Lighting — Automatically — The Instant Power Fails

A sudden blackout plunging your premises into darkness can prove costly and dangerous. Help avert panic . . . injury . . . death . . . install Automatic Emergency Lights now.

EMERGENCY LIGHTS . . . snap into action the instant your current fails . . . a blown fuse . . . a bad storm . . . or a major disaster. They flood the protected area with light from their own power!

For industrial plants, stores, theatres, auditoriums, churches, schools, restaurants, hotels, clubs, hospitals, control rooms, transportation terminals, firehouses, police stations, power sub-stations, telephone exchanges . . . wherever people congregate or operations must go on. Discourage theft and sabotage and protect against property damage. Furnish emergency light to allow operation of switches, valves, controls. Permit evacuation of premises without panic. Quickly installed anywhere there is an electric outlet.



WM and WM Junior

Automatic Stand-by Light with rechargeable Battery.

WM Illuminates 10,000 square feet for approximately 4 hours. Self-contained, portable . . . can be carried for rescue or emergency work. Cost of operation is only a fraction of a cent per day. Maintenance required is negligible. Sufficient capacity for additional lamp heads and any or all lamp heads may be mounted away from the unit. Built-in automatic trickle charger maintains battery charge. Built-in fast charger quickly restores battery after an emergency. Streamlined and beautifully finished to harmonize with any surroundings where appearance is important, yet so sturdily built as to provide years of trouble-free operation in heavy industrial plants. Completely automatic, dependable in performance and fool-proof.

BATTERY—Special Watchmaster 6 volts. **BULB**—Carpenter No. 76-C (Carpenter 36-C for small areas). **SIZE**—8" x 13½" x 18" high; 6½" lamp head. **WEIGHT**—60 lbs., with battery.

WM JUNIOR Essentially the same construction as the WM except that it has 25 watt sealed beam lamp heads. The unit is supplied with special rechargeable battery, delivers about ⅓ less light than the WM but with a longer illumination period of 8 or more hours; recommended for small areas.

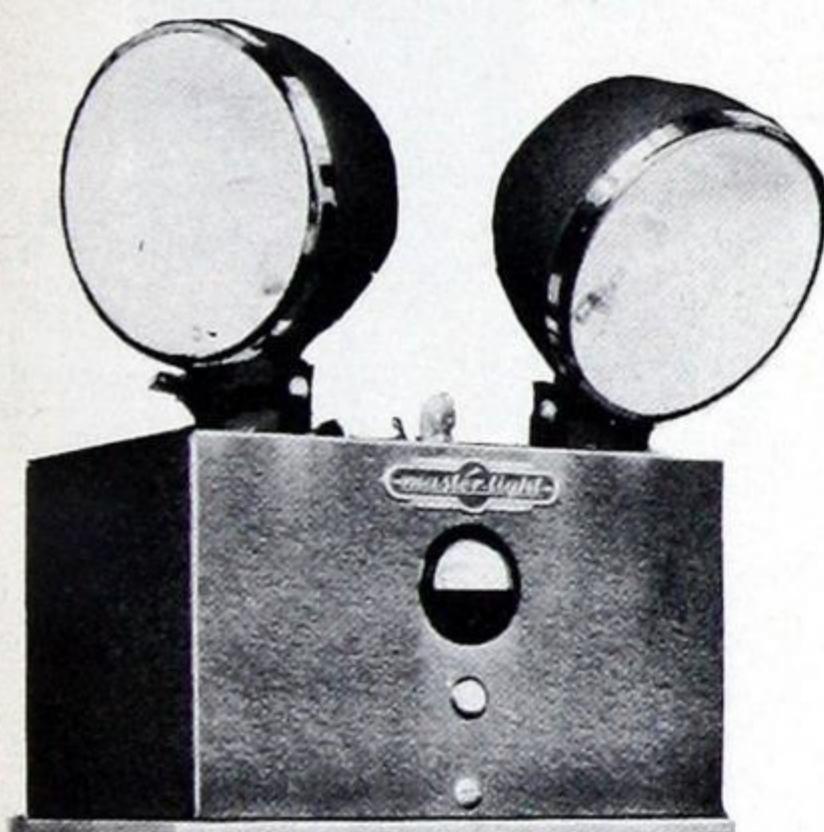

CJ and CJ Junior

CJ—A moderate priced Twin Head unit, adaptable for installations requiring more illumination than a single head supplies . . . or where two or three smaller rooms must be lighted. Dependable and economical . . . both heads will illuminate adequately for emergency purposes a room 30' x 60'. Where two rooms must be illuminated, one head may be removed, installed in another room and operated from the same unit. A third head can be added . . . the extra head at small additional cost.

Meets all usual safety requirements, has a pilot bulb, volt meter and switch for quick test. Attractive and easy to install.

***BATTERY**—7½ volt dry battery pack (2 required). **BULB**—Carpenter No. 36-C. **SIZE**—8" x 12" x 14½" high; 6½" diameter lamp head. **WEIGHT**—24 lbs. with batteries.

CJ JUNIOR—Similar construction to CJ except that it has 25 watt sealed beam lamp heads. Requires two 7½ volt dry battery packs*.

*Batteries not included.



A-I-H

Dependable . . . attractive . . . and low in cost. Quickly installed . . . Just Plug "All-In-Head" into any regular light socket to go on the instant regular lights fail. Point floodlight where it will do the most good and forget it except for occasional easy battery tests.

One Carpenter "All-In-Head" will illuminate for emergency purposes a room 30' x 30'. Light may be screwed to wall . . . its battery shelved or hidden behind partition. Or it may be clamped to battery and placed on a convenient shelf. Has a beautiful satin finish.

Normally supplied with 36-C bulb for small areas providing 4-5 hours illumination period. If specified type 76-C bulb will be supplied suitable for lighting larger area for a period of 2 hours. Attractive grey enamel metal housing for battery available if specified.

***BATTERY**—7½ volt dry battery pack. **BULB**—Carpenter No. 36-C. **LAMP HEAD**—6½" diameter. **WEIGHT**—10 lbs. with battery.

*Battery not included.

AJ-24

This unit is similar to the J24 Portable Hand Lamp illustrated on next page and may be used as such. The AJ-24 unit, however, is equipped with a relay and may be connected to the electrical system as an emergency light. Immediately the power fails, the unit is automatically switched on. It is a trusty 2-cell emergency lantern . . . standard for years. Sturdiest on the market with an oversize reflector and bulb to give more than twice the light. Strong, yet lightweight because the case is cast aluminum. Instant replacement of batteries . . . no screws to remove. Waterproof. Focusing screw. Powerful beam with a wide spot. Hanging bracket available, if required.

***BATTERY**—2 No. 6 dry cells. **BULB**—Carpenter No. 23-C. **SIZE**—7¾" x 5" x 9" high; 5½" lamp head. **WEIGHT**—7½ lbs. with batteries.

*Batteries not included.





PORTABLE HAND LAMPS

G-23

TYPE G-23—For Watchmen, Patrolmen, Firemen, etc. Featherweight—only 72 ounces complete. Watchman's filament provides 15 hours or 1 to 2 nights service per battery charge, with high power second filament for emergencies. Range $\frac{1}{3}$ mile. Battery is fully non-spillable even if inverted . . . corrosion proof terminals . . . automatic filling control. Spare battery can be inserted in 10 seconds. The savings over dry battery replacements in one year can pay for the G-23 Lantern twice over. Special shoulder strap and running board holder available if specified. Battery included.

BATTERY—2-volt rechargeable, 22-ampere hour. Fully "spill-proof". **BULB**—Carpenter No. 42-C. **SIZE**— $5\frac{1}{8}$ " x 8" x 11" high; $5\frac{1}{2}$ " lamp head. **WEIGHT**—72 oz. with battery.



DB-2

Most powerful 2-cell handlight made . . . a rugged service unit, not to be confused with usual hand lanterns. Focusing button. Rubber guard protects lens. Over-size reflector and special bulb projects $\frac{1}{3}$ mile beam. Steel case, baked enamel finish.

***BATTERY**—2 No. 6 dry cells. **BULB**—Carpenter No. 23-C. **SIZE**— $5\frac{1}{8}$ " x 8" x 11" high; $5\frac{1}{8}$ " lamp head. **WEIGHT**—7 lbs. with batteries.

*Batteries not included.

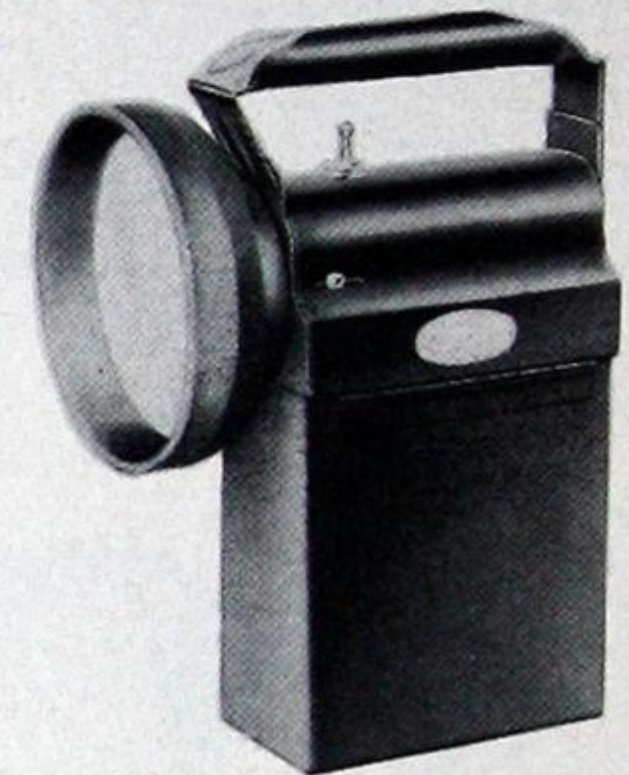

J-24

Time-tried trusty 2-cell emergency lantern . . . standard for years. Sturdiest on the market with an oversize reflector and bulb to give more than twice the light. Strong, yet light-weight because the case is cast aluminum. Instant replacement of batteries . . . no screws to remove. Waterproof. Focusing screw. Powerful beam with a wide spot.

***BATTERY**—2 No. 6 dry cells. **BULB**—Carpenter No. 23-C. **SIZE**— $7\frac{3}{4}$ " x 5" x 9" high, $5\frac{1}{8}$ " lamp head. **WEIGHT**— $7\frac{1}{2}$ lbs. with batteries.

*Batteries not included.



TNT

A 2-Way Flood and Searchlight, favorite with telephone and public utility repair men fire departments and others. Gives a 10 ft. spot of even light atop a 40 ft. pole or an adequate work light on the ground. For fire departments, one white beam and one red warning light can be supplied, with or without flasher, if specified when ordering. Range $\frac{1}{3}$ mile. Sturdy, rustproof steel case, heavily enameled. Focusing knob for changing intensity and size of spot.

***BATTERY**—2 No. 6 dry cells. **BULB**—Carpenter No. 23-C. **SIZE**— $10\frac{1}{4}$ " x $5\frac{1}{8}$ " x $11\frac{1}{2}$ " high; $5\frac{1}{8}$ " lamp heads. **WEIGHT**—9 lbs. with battery.

*Batteries not included.

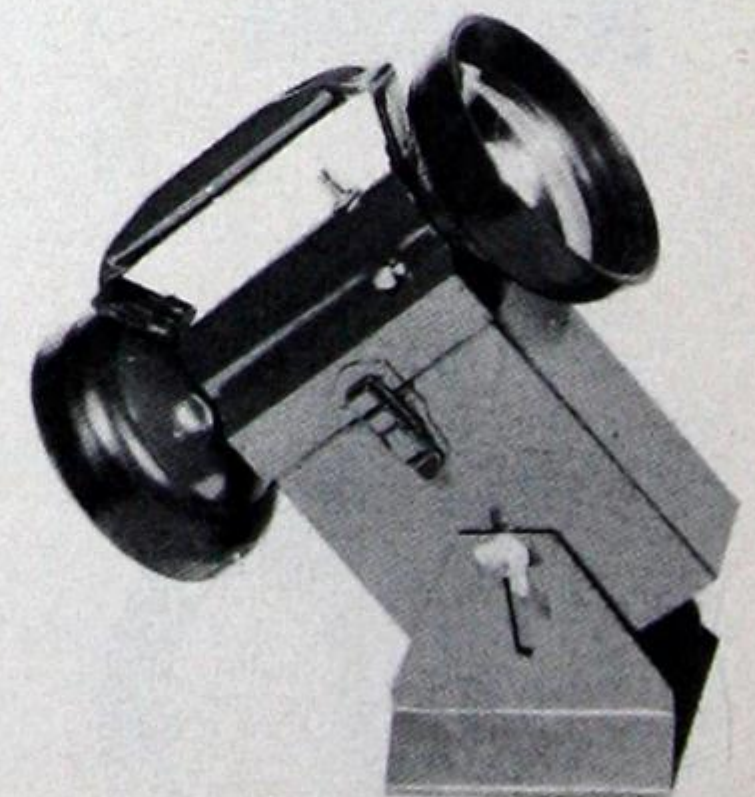



PORTABLE SEARCHLIGHTS

Super 4 and Super 6

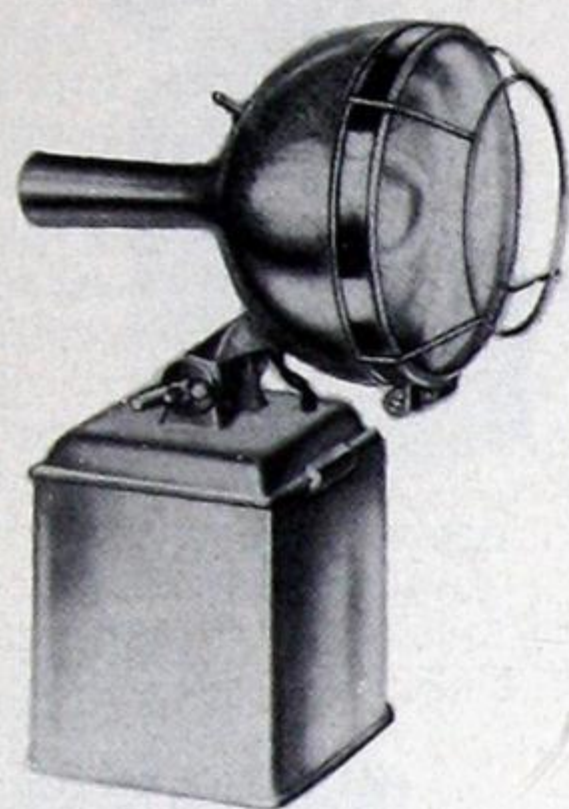

Portable Searchlights with rechargeable batteries are practical and economical where use is frequent. Savings over dry battery replacements quickly repay higher original cost. Rechargeable batteries are safe, convenient and easily kept at maximum efficiency. It takes only 10 seconds to slip spare batteries into place because corrosion-proof terminals and spring contacts eliminate screw terminals. However, if lights are used infrequently, or if batteries cannot be given reasonable care, we recommend Types F-5, BF-5 or DB-5 below.

SUPER-6 SEARCHLIGHT WITH 6 VOLT BATTERY has mile range. It furnishes a moderate work light for 24 continuous hours or a powerful searchlight beam for 8-10 hours per battery charge . . . much longer in intermittent use. Its 6-volt, 20-ampere hour battery is semi-non-spillable. Beautiful duro-satin finish. Running board holder and smoke and fog penetrating lens available if specified. Battery included.

BATTERY—6-volt rechargeable 20-ampere hour. **BULB**—Carpenter No. 27-C. **SIZE**—10" x 6¼" x 13" high; 6¼" lamp head. **WEIGHT**—11 lbs. with battery.

SUPER-4 SEARCHLIGHT WITH 4-VOLT BATTERY. Similar to and for same general uses as Type Super-6 above. Lighter in weight, smaller (4-volt) battery. Will not spill even if inverted. About half the burning hours per battery charge. Light in weight but a little giant in performance. Widely used by commercial airlines at home and abroad. Battery included.

BATTERY—4-volt rechargeable, 21-ampere hours. Fully "spill-proof". **BULB**—Carpenter No. 24-C. **SIZE**—9" x 6¼" x 13" high; 6¼" lamp head. **WEIGHT**—9 lbs. with battery.

Type WS-4

Uses special 23-ampere hour rechargeable battery in clear plastic case. Ball floats, visible through plastic windows in rugged cast aluminum box, tell state of charge. Can plug in on your auto circuit for recharge and continuous trickle charge. "Spill-proof" even if inverted.

Weight is always directly under the hand; beam instantly tilted to any height by simple fingertip pressure without "cocking" the arm. Easy to handle.

Moderate work light for 15 hours continuously—or mile range powerful searchlight for 4 hours—much longer intermittently—per battery charge. Special double filament bulb gives long burning low power consumption service light, or brilliant mile range searchlight. One switch for both filaments. Running board holder and smoke and fog penetrating lens available if specified. Battery included.

BATTERY—4-volt rechargeable, 23-ampere hour. Fully "spill-proof". **BULB**—Carpenter No. 24-C. **SIZE**—9" x 6" x 13" high; 6¼" lamp head. **WEIGHT**—13½ lbs. with battery.

Type WS

Similar in appearance and intended for same general uses as Type WS-4. Rechargeable battery of lighter weight but longer burning period. Moderate work light for 24 hours continuously or powerful mile range searchlight for 8 hours . . . much longer intermittently . . . per battery charge. Its 6-volt, 20-ampere hour battery is semi-non-spillable. (Does not have ball float hydrometer or windows as in WS-4). Cast aluminum case; duro-satin finish. Battery included.

BATTERY—6-volt rechargeable, 20-ampere hour. **BULB**—Carpenter No. 27-C. **SIZE**—6" x 10" x 13" high; 6¼" lamp head. **WEIGHT**—11 lbs. with battery.

Type F-5 Series

For General Emergency, Police, Fire, Industrial and Civilian requirements. There's no better light for outdoors, country, marine and hundreds of special uses. Clamps on 7½ volt dry battery pack.

TYPE F-5 PORTALITE has mile range. For many users one F-5 Battery lasts a year. It furnishes a moderate work light for 24 consecutive hours or a powerful searchlight for 8-10 hours, much longer if used intermittently. Holder for carrying light on running board available.

TYPE F-5F. Same as F-5 except with built-in flasher on low power filament only.

TYPE FF-5. Same as F-5 except flashing red warning light at rear of handle.

***BATTERY**—7½-volt, Carpenter Featherweight Dry Battery Pack. **BULB**—Carpenter No. 27-C. **SIZE**—10" x 6¼" x 14" high; 6¼" lamp head. **WEIGHT**—9½ lbs. with battery.

*Battery not included.

TYPE BF-5. Same unit as Type F-5 (shown above) except the light is mounted on a rugged cast aluminum case in duro-satin finish, to hold battery. Same accessories available. Order BF-5F for built-in flasher; BFF-5 for flashing light in handle.

***BATTERY**—7½-volt Carpenter Featherweight Dry Battery Pack. **BULB**—Carpenter No. 27-C. **SIZE**—7¾" x 4¾" x 15" high; 6¼" lamp head. **WEIGHT**—14 lbs. with battery.

*Battery not included.





PORTABLE SEARCHLIGHTS

DB-5

Specially designed for railroad, telephone and utility repair crews requiring a sturdy, heavy duty, portable light. Powerful mile range, or a long-burning low power consumption floodlight. Rugged cast aluminum case, duro-satin finish. If specified, a floodlight reflector for illuminating an 80 ft. circle will be substituted at no extra cost.

*BATTERY—5 No. 6 or telephone type dry cells. BULB—Carpenter No. 27-C. SIZE—8" x 6 3/4" x 15" high; 6 1/4" lamp head. WEIGHT—18 lbs. with batteries.

*Batteries not included.

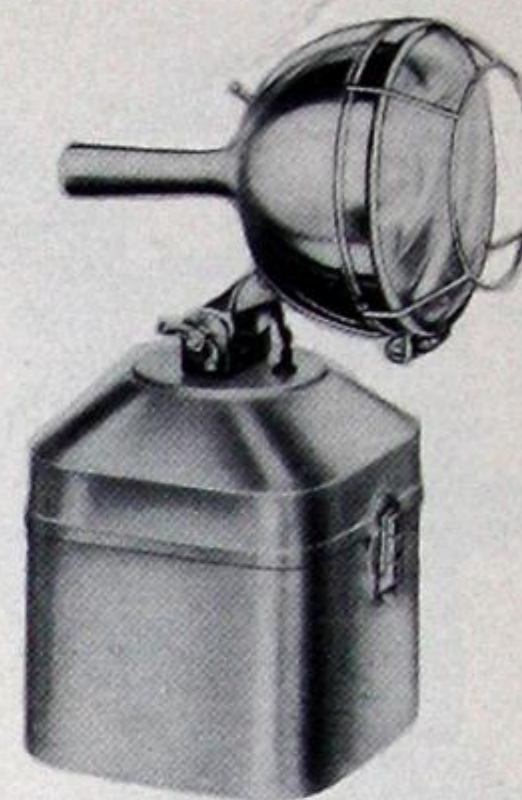

C. D. U.

Emergency Rescue Light

Indispensable when emergencies strike . . . this dependable Carpenter light will help save lives and aid in disaster control! Ideal for general use or for use in defense plants and by fire, police, first aid, rescue, demolition squads, etc.

Powered by a heavy duty, rechargeable long life battery, a special Carpenter 2-filament bulb furnishes work or rescue light for 80 continuous hours on one filament—or a higher power floodlight for 20 consecutive hours on the second filament—much longer if used intermittently. 3-way thumb-operated toggle switch controls both filaments. Mile range searchlight reflector may be substituted, if requested.

Shatter-proof lens. Rugged cast aluminum case. Perfectly balanced and easy to handle.

Center of gravity is always directly under the hand. Beam may be instantly tilted to any height by fingertip pressure without cocking the arm. Includes provision for charging battery direct from automobile.

BATTERY—6-volt, 85-ampere hour. BULB—Carpenter No. 27-C. SIZE—7" x 12" x 16" high; 6 1/4" lamp head. WEIGHT—40 lbs. with battery.



DF

Twin Head Flood and/or Searchlight for work crews and car loaders, fire departments, construction gangs, etc. Floodlight over 100 ft. circle or a powerful one mile searchlight. Flood or searchlight reflectors or a combination of both as specified. Clamps on any automobile battery.

*BATTERY—6-volt rechargeable. BULB—Carpenter No. 27-C. LAMP HEADS—6 1/4" diameter. WEIGHT—7 lbs. without battery.

*Battery not included.

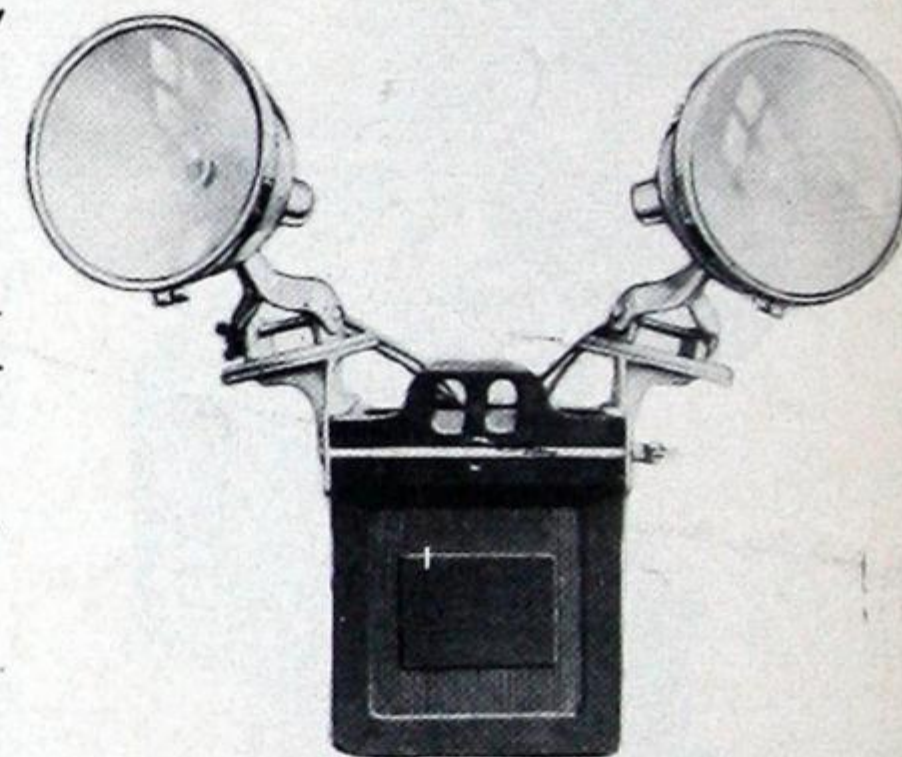

Battery Charger

DIMENSIONS—3" x 4" x 5". For use in charging WS, SUPER 6, WS-4 and G-23 batteries. Has pop-out fuse to prevent incorrect hook-up. For 110-120 volt, 60 cycle, A.C. current.



Control Unit

DIMENSIONS—3" x 4" x 5 1/2". Small resistance unit for connecting to automotive battery or car battery charger to control charging rate. For use with small rechargeable CARPENTER batteries.

Accessories

Plain and Fresnel type lenses are available in red, blue, green and amber, plain lenses are also available in clear and frosted. When ordering lenses, replacement flashers, bulbs and batteries specify for which type of unit they are required.



INDEX

ALPHABETICAL INDEX

A

Accessories	
Display Spotlight	91
Enclosed Recessed Units	60, 86
Fluorescent CurtiStrip	154, 158
Fluorescent Units	138, 142, 143, 144
Incandescent CurtiStrip	103
Incandescent Show-Window Units	99
Luminous Ceilings	150
Open-Type Recessed Units	63
Portable and Emergency Lights	208
Stage Lighting	201
Adjustable Portable Lamps	104
Adjustable Swivelite Units	90
Aluminum Units—Fluorescent	145
Aluminum Units—Recessed Troffers	174
Astralite Unit	137

B

Baby Spotlights	192
Ballasts	
Fluorescent	180
Slimline	182
Wiring Diagrams	183
Balustrade Units	102
Batten Boxes	201
Battery Charger	208
Bookstack Unit	77
Borderlights	193
Box Lights	195
Brackets	
Fluorescent	160
Outside	102
Butt-On Lampholder	179

C

Cam-Loc Lampholders	179
Ceiling Bands	96
Challenger Units	50
Church Lighting Units	98
Colour Roundels	201
Commercial Fluorescent & Slimline Equipment	108
Commercial Incandescent Equipment	48
Correctalite	78
Corridor Unit	76
Corri-Lite Units	147
Counterlite	74
Cove Lighting Units	161
CurtiStrip	
Fluorescent Mogul	156
Fluorescent Standard	153
Hangers	103, 159
Incandescent	103

D

Dawn-12 Units	145
Dawn-16 Units	145
Dawn-22 Units	146
Dazor Lamps	104
Design Data	
Basic	12
Commercial	36
Stage Lighting	186
Direction Signs Fluorescent	160
Disappearing Footlights	196
Display Spotlights	89
Downlights	89

E

Educator Units	136
Emergency Lights	205
Emergency Rescue Light	208
Exit Globes	95
Exit Light Units	100

F

Filterlite Unit	77
Fixture Hangers	96, 103, 112, 116, 119, 122, 125, 131, 134, 136, 141, 146
Flex-Loc Lampholders	179
Fluorescent Accessories	178
Footlights	196
Forty-Sixty-One Units	140
Forty-Sixty Units	140

G

Glassware	93, 97
Gymnasium Unit	100
Gyro-Lite	92

H

Hand Lamps—Portable	206
Hangers—CurtiStrip	103, 159
Hangers—Fluorescent	109, 111, 114, 115, 118, 121, 124, 127, 130, 133, 136, 140, 141, 143
Hangers—Incandescent	96, 103
Holoflux Units	144
Horizon Units	139
Hospital Bed Lamp	83
Hospital Lighting Units	81
Hospital Night Light	85

I

Indirect Units—Incandescent	
Edge-Mont	58
Edge-Ray	58
Urna	59
Winner	58

L

Lampholders—Fluorescent	
Cam-Loc	179
Flex-Loc	179
Standard	179
Turret	179
Lamps	
Base Types	26
Bulb Types	26
Filament Types	26
Lamps—Fluorescent	
Circline	32
General Line	32
Instant Start	32
Slimline	33
Lamps—Incandescent	
Aviation	30
Country Home	30
Floodlight	31
General Service	27
High Voltage	29
Infrared	31
Locomotive	30
Low Voltage	30
Projection and Stereopticon	29
Projector	29
Reflector	29
Spotlight	31
Street Railway	30
Street Series	31
Train	30
Lamps—Mercury	33
Lenox Units	120
Light and Sound Conditioning System	151
Louver Lights	84
Louvers	89, 99
Luminous Ceilings	148
Luve-Tile	148
Luvex Units	126



INDEX

ALPHABETICAL INDEX

M

Marine Searchlights.....	203
Medical Examination Unit.....	82
Modelite.....	74
Modulite Control.....	202

N

Neptune Units.....	135
Night Lights.....	75, 85
No-Box Unit.....	75

O

Olivettes.....	195
Open Type Recessed Units—Incandescent.....	62
Open Type Units—Fluorescent.....	108, 139
Open Type Units—Slimline.....	139
Ornamental Standards.....	102
Outdoor Units Incandescent.....	101

P

Pacemaker Units.....	139
Par-Beam-Lite.....	92
Plexoline Units.....	129
Pockets—Stage.....	199
Portable and Emergency Lights.....	203
Portable Units	
Control Unit.....	208
Emergency Rescue.....	208
Hand Lamps.....	206
Searchlights.....	207
Street Warning Lights.....	204
Postop Unit.....	101
Pot Lamp Units.....	100
Prismatic Glassware Units—Incandescent	
Correctalite.....	78
Corridor Unit.....	76
Counterlite.....	74
Enclosed Recessed.....	71
Filterlite.....	77
Hospital Lighting Units.....	81
In-Bilt Flush.....	71
In-Bilt Surface.....	73
Modelite.....	74
Night Light.....	75
No-Box Unit.....	75
Reflector-Refractor Unit.....	79
Stock Room Unit.....	77
Vertical Surface Lighting Unit.....	73
Psychiatric Unit.....	82

R

Radio Suppressors.....	183
Recessed Troffer Units	
Aluminum.....	174
Flange Type.....	164
Incandescent Units for.....	171, 174
Shallow Troffers.....	172
Snap-In Type.....	167
Toggle Type.....	176
Recessed Units—Incandescent	
Accessories.....	60, 86
Enclosed.....	60, 71, 186
Less Reflectors.....	86
Night Light.....	75
Open Type.....	62, 75
Show-Window Units.....	99
Skylike.....	52
With Prismatic Glassware.....	68
With Silver Glass Reflector.....	60
Reflector-Refractor Unit.....	78
Rescue Light.....	208

S

Safety Hangers—Incandescent.....	96
Searchlights	
Marine.....	204
Portable.....	207
Semi-Indirect Units—Incandescent	
Magna.....	57
Midas.....	57
Semi-Recessed Units—Incandescent	
Correctalite.....	78
Down Lights.....	90
In-Bilt Flush.....	76
Skylike.....	52
Shallow Recessed Troffers.....	172
Shielded Units	
Fluorescent.....	113
Incandescent Spots for Continuous Row.....	142
Slimline.....	126, 137
Showcase Units.....	162
Show-Window Reflectors—Incandescent.....	99
Show Window Units—Fluorescent.....	161
Silver Bowl Direct Units—Skylike.....	52
Silver Bowl Indirect Units	
Challenger.....	50
Sno-Flake.....	51
Silvered Glass Units—Incandescent	
Enclosed Recessed.....	60
Open-Type Recessed.....	62
Show-Window Units.....	99
Skylike Units.....	52
Slimline Shielded Units.....	126, 137
Spotflood Unit.....	200
Spotlights—Stagelighting.....	191
Spotlights—Swivel.....	89
Stage Lighting.....	186
Stage Pockets.....	199
Starters.....	178
Starter Sockets.....	179
Statesmen Units.....	143
Stockroom Unit.....	77
Store-Liter Units.....	142
Striplighting Incandescent.....	103
Striplighting Units—Fluorescent.....	153
Suppressors Radio.....	183
Surface Footlights.....	198
Surface Units—Incandescent	
Display Spotlight Unit.....	91
Down Lights.....	90
Glassware Units.....	97
Round.....	88
Skylike.....	53
With Prismatic Glassware.....	73
Suspension Hangers—Incandescent.....	96
Swivelite Units.....	90

T

Topnotch Units.....	109
Troffers—Recessed.....	164
Turret Lampholders.....	179

V

Vertical Surface Lighting Units.....	73
Viz-Aid Units.....	113

W

Warning Lights Portable Unit.....	204
-----------------------------------	-----



INDEX

Numerical Index

NUMERICAL INDEX

Cat. No.	Page	Cat. No.	Page	Cat. No.	Page	Cat. No.	Page
A-1-H	205	F-1778-M	74	K-324-48	161	P-132	89
A-739-60	82	F-1814	74	K-332-24	161	P-140	89
A-739-100	82	FF-5	207	K-332-48	161	P-141	89
A-739-150	82	FF51	199	K-333-24	161	P-142	89
A-765	82	FF52	199	K-333-48	161	P-143	89
AJ-24	205	FF53	199	K-334-24	161	P-144	89
B-2R	193, 194	FF54	199	K-334-48	161	P-150	89
B-103	193, 194	FF55	199	K-412-48	139	P-151	89
B-106	193, 194	FF101	199	K-414-48	139	P-152	89
B-156	193, 194	FF102	199	K-512-48	136	P-153	89
B-208	193, 194	FS-2	178	K902-48	176	P-154	89
B-431A	171	FS-4	178	K903-48	176	P-155	89
B-431B	171	FS-4DC	178	KE902-48	176	P-156	90
B-431C	171	FS-6	178	KE903-48	176	P-157	90
B-431D	171	FS-12	178	KG-261-18	160	P-158	90
B-512	193, 194	FS-20	178	KG-552-24	138	P-159	90
BCF-12	200	FS-20-FA	178	KG-552-48	138	P-160	90
BF-5	207	FS-25	178	KG-636-18	160	P2124-16	105
C-651	179	FS-30	178	KG-637-18	160	P2134-16	105
C651W	179	FS-40	178	KG-638-18	160	P2234-16	105
C-653	179	FS-40-FA	178	KG-639-18	160	P2324-16	106
C653W	179	FS-44	178	KG-646-18	160	P2434-16	106
C-2120	79	FS-64	178	KG-648-18	160	PR-10	88
C-2130	79	FS-120	178	KG902-48	176	PR-11	88
C-2133	79	FS-185	178	KG903-48	176	PR-12	88
C-2140	79	FS-850	178	KGL-552-24	138	PR-43	86, 87
C-2143	79	FW51	199	KGL-552-48	138	PR-45	86, 87
C-2172	76	FW52	199	KGL-554-24	138	PR-46	86, 87
C-5540	78	FW53	199	KGL-554-48	138	PR-47	86, 87
CDU	208	FW54	199	KL902-48	176	PR-48	86
CF-200	77	FW55	199	KL903-48	176	PR-49	86, 87
CG-951-24	161	FW101	199	KM-552-24	138	PR-49A	86
CG-951-48	161	FW102	199	KM-552-48	138	PR-130	89
CG-952-24	161	G-23	206	KML-552-24	138	PR-140	89, 90
CG-952-48	161	H-11	136	KML-552-48	138	PR-150	89, 90
CIB-18	201	H-21	136	KML-554-24	138	PR-283	86, 87
CJ	205	H-22	136, 137	KML-554-48	138	PR-700	89
CJ Jr.	205	H-31	136, 137	KP-271-18	160	PR-790	88
CS-5000	82	H-41	136, 137	KP-552-24	138	PR-791	88
D-2R104	197	H-42	136, 137	KP-552-48	138	R-1894	75
D-63-B	197	H-2076-S	77	KP-882-48	135	R-2120	79
D-104	197	HOL-104	144	KP-884-48	135	R-2130	79
D-156	197	HOL-114	144	KPL-552-24	138	R-2140	79
DB-2	206	HOL-124	144	KPL-552-48	138	R-2460	76
DB-5	208	J-24	206	KPL-554-24	138	R-2470	76
DF	208	K1-36	162	KPL-554-48	138	R-2472	76
E-796	73	K2-36	162	KPL-562-48	139	R-2476	76
E-796-2	73	K2-54	162	KPL-564-48	139	R-2772	75
E-1814	74	K2-72	162	L67	85	R-2773	75
E9848-24	83	K-41-18	160	L68	84	R-5544	78
E9848-48	83	K-51-18	160	L-130	89	RH-1	204
EC-69	59	K-52-24	138	L-140	89, 90	S-2	91
F2R-156	198	K-52-48	138	L-700	90	S-3	91
F-5	207	K-54-24	138	LCS134	147	S-4	91
F-5F	207	K-54-48	138	LCS144	147	S-5	91
F-106	198	K-201-18	160	LCS178	147	S-6	91
F-156	198	K-201-24	160	LCS238	147	S-7	91
F-200	77	K-201-48	160	LCS248	147	S-10	91
F-796	73	K-301-18	160	LCS2716	147	S-11	91
F-796-2	73	K-301-24	160	M-179	67	S-12	91
F-1570	69, 70	K-301-48	160	M-179RB	66	S-13	91
F-1715-1	81	K-301-96	160	M-180	67	S-21	91
F-1715-3	81	K-302-24	160	M-180RB	66	S-21A	91
F-1739	72	K-302-48	160	M-181	67	S-22	91
F-1748	72	K-303-24	160	M-181RB	66	S-23	91
F-1765	71	K-303-48	160	M-182	67	S-31	91
F-1765-2	71	K-304-24	160	M-182RB	66	S-31A	91
F-1765-3	71	K-304-48	160	M-183	67	S-32	91
F-1765-4S	71	K-322-24	161	M-183RB	66	S-33	91
F-1774	71	K-322-48	161	NRF	204	S-34	91
F-1774-2	71	K-323-24	161	NRFX	204	S-35	91
F-1774-3	71	K-323-48	161	P-130	89	S-700	89
F-1774-4S	71	K-324-24	161	P-131	89	S-2120	79



INDEX

Numerical Index

Cat. No.	Page	Cat. No.	Page	Cat. No.	Page	Cat. No.	Page
S-2130	79	6F	201	58G985	181	89G635	183
S-2133	79	6L	201	59G276	181	95x102	179
S-2140	79	8L	201	59G347	181	95x123	179
S-2143	79	8PL	201	59G352	181	95x168	179
S-5540	78	9	103	59G369	181	95x180	179
S-5630	51	10	88	59G373	181, 182	95x267	179
S-5640	51	10F	201	59G420	181	95x273	179
SD-739-100	73	10SB	201	59G425	181	95x311	179
SD-739-150	73	11	88	59G458	182	95x498	179
SL-52-96	138	12	88, 103	59G464	182	95x934	179
SL-54-96	138	13	103	59G740	182	95x935	179
SL-412-96	139	14	103	59G741	182	95x936	179
SL-414-96	139	15	103	59G742	182	95x973	179
SLG-552-96	138	16	103	59G743	182	95x974	179
SLG-554-96	138	17A5	181	59G744	182	95x975	179
SLM-552-96	138	17A6	181	59G745	182	95x976	179
SLM-554-96	138	17A7	181	59G770	182	102-S	155
SLP-552-96	138	17A8	181	59G771	182	103-S	155
SLP-554-96	138	18	103	59G772	182	104-S	155
SLP-562-48	139	19	103	59G773	182	105-S	155
SLP-562-96	139	19-BX	103	59G774	182	106	192, 204
SLP-564-48	139	20	88, 103	59G775	182	106-S	155
SLP-564-96	139	21	88, 103, 201	59G779	182	107-S	155
SLP-882-48	135	22	88	59G781	182	108	192
SLP-882-96	135	23	103	59G790	182	108-S	155
SLP-884-48	135	24	103	59G791	182	109-S	155
SLP-884-96	135	25F214	183	59G792	182	114-S	155
SS-2	91	32	201	59G793	182	115-S	155
SS-3	91	35	88	59G794	182	116-S	155
SS-4	91	40	192	59G795	182	117-S	155
SS-5	91	43	86	59G798	182	160	95
SS-6	91	45	86	59G799	182	201-CS	153
SS-7	91	46	86, 155	59G908	181	202-CS	153
SS-10	91	47	86	59G909	181	202-ECS	153
SS-11	91	48	86	59G910	181	207/5	50
SS-12	91	49	86	59G947	182	207/10	50
SS-13	91	49A	86	59G948	182	207-PL/5	50
SS-21	91	50	54, 201	59G949	182	208-CS	153
SS-21A	91	50F	54	59G964	182	209-CS	153
SS-22	91	51/150	54	59G972	181, 182	210-PL/5	50
SS-23	91	51/200	54	63	87	210-PL/10	50
SS-31	91	51/300	54	64	201	211-CS	153
SS-31A	91	51/500	54	65	87	212-CS	153
SS-32	91	53	87	67	87	213-CS	153
SS-33	91	53/200	54	69	87	214-CS	153
SS-34	91	53/300	54	74	87	214-ECS	153
SS-35	91	53FM	54	76	87	215-CS	153
Super 4	207	54A	54	77	87	216-CS	153
Super 6	207	54P	54	78x354	179	216-ECS	153
SW51	199	55	54	78x491	179	250	192
SW52	199	55F	54	78x729	179	251	192
SW53	199	56	54	78x736	179	252	192
SW54	199	57	87	78x769	179	263	87
SW55	199	57A	87	82	84	271	102
SW101	199	58G628	181	82CP	84	274	102
SW102	199	58G640	181	82T	84	283	86
TNT	206	58G641	181	82TCP	84	292-CS	153
W-792	75	58G649	181	83	86	293-CS	153
WM	205	58G670	181	85	86	293ECS	153
WM Jr.	205	58G671	181	87	86	298-CS	153
WS	207	58G678	181	89G300	181	299-CS	153
WS-4	207	58G679	181	89G304	181	301-CS	153
02076	77	58G691	181	89G307	181	302-CS	153
04340	101	58G692	181	89G320	181	304-CS	153
099	144	58G696	181	89G321	181	305-CS	153
1	103, 155	58G818	181	89G332	181	305-ECS	153
1-A	103, 155	58G848	181	89G343	181	306-CS	153
1-B	103, 155	58G862	181	89G344	181	308-CS	153
1SF-1050	200	58G864	181	89G347	181	308-ECS	153
4L	201	58G914	181	89G396	182	310-B	83
5	99, 103	58G940	181	89G400	181, 182	327-CS	153
5-A	103	58G980	181	89G413	181	328-CS	153
6	103, 155	58G983	181	89G414	181	328-ECS	153



INDEX

Numerical Index

Cat. No.	Page	Cat. No.	Page	Cat. No.	Page	Cat. No.	Page
333-CS	153	468-CS	153	900	201	1199	158
334-CS	153	468-ECS	153	950H	179	1201-C4	156
336-CS	153	469-CS	153	950L	179	1201-C8	157
337-CS	153	469-ECS	153	1000	158	1201-CE8	157
339-CS	153	473	94	1001	158	1202-C5	156
340-CS	153	490-CS	153	1004	97, 158	1202-C10	157
340-ECS	153	491-CS	153	1005	158	1202-CE10	157
341-CS	153	492-CS	153	1006	97, 158	1203-C5	156
342-CS	153	493-CS	153	1008	158, 204	1203-C10	157
342-ECS	153	493-ECS	153	1009	142, 159	1203-CE10	157
350	195	494-CS	153	1010	99	1204-C6	156
351	195	495-CS	153	1010-C	99	1204-C12	157
356	179	495-ECS	153	1016	159	1204-CE12	157
356W	179	496-CS	153	1026	159	1205-C8	156
375	201	496-ECS	153	1028	204	1205-C16	157
381-CS	153	500	99	1049-9	97	1205-CE16	157
383-CS	153	500-C	99	1049-12	97	1206-C4	156
383-ECS	153	501	155	1049-14	97	1206-C8	157
387-CS	153	502	155	1049-16	97	1206-CE8	157
388-CS	153	502x6	179	1049-18	97	1212-C4	157
389-CS	153	502x7	179	1050	179	1212-CE4	157
390-CS	153	502x21	179	1050W	179	1213-C4	157
391-CS	153	502x22	179	1051	179	1213-CE4	157
392-CS	153	502x47	179	1051W	179	1214-C5	157
393-CS	153	502x48	179	1052	179	1214-CE5	157
393-ECS	153	502x63	179	1052W	179	1215-C5	157
394-CS	153	502x64	179	1053	179	1215-CE5	157
395-CS	153	503	155	1053W	179	1216-C6	157
395-ECS	153	504	155	1060	192	1216-CE6	157
402	102	505	155	1061	192	1217-C8	157
411-CS	153	520	95	1062	192	1217-CE8	157
412-CS	153	522	95	1080	159, 192	1250	58
413-CS	153	523	95	1081	159, 192	1260	58
413-ECS	153	524	95	1082	159, 192	1270	58
414-CS	153	526	95	1083	159	1280	58
415-CS	153	527	95	1084	159	1301-C4	156
415-ECS	153	530	99	1085	159	1301-C8	157
416-CS	153	530-C	99	1095	158	1301-CE8	157
416-ECS	153	534	95	1096	158	1302-C5	156
420	99, 101	535	95	1097	158	1302-C10	157
420-C	99	536	95	1098	158	1302-CE10	157
427-CS	153	539	95	1099	158	1303-C5	156
428-CS	153	550	95	1100	158	1303-C10	157
429-CS	153	551	95	1101	158	1303-CE10	157
430-CS	153	552	95	1101-S	102	1304-C6	156
432-CS	153	558	201	1104	158	1304-C12	157
433-CS	153	613	154	1105	158	1304-CE12	157
434-CS	153	614	154	1106	158	1305-C8	156
435-CS	153	615	154	1108	158	1305-C16	157
437-CS	153	616	154	1125	201	1305-CE16	157
438-CS	153	617	154	1126	159	1306-C4	156
439-CS	153	618	154	1170	97	1306-C8	157
442-CS	153	619	154	1171-S	102	1306-CE8	157
444-CS	153	620	154	1174	96	1312-6	97
445-CS	153	621	154	1175	96	1312-8	97
446-CS	153	622	154	1176	96	1312-10	97
447-CS	153	628	141	1176M	96	1312-12	97
450	179	629	141	1177	96	1312-C4	157
452	179	630	141	1177M	96	1312-CE4	157
454-CS	153	631	141	1178	96	1313-C4	157
455-CS	153	656	92	1180	96, 159	1313-CE4	157
456-CS	153	657	92	1180M	96	1314-C5	157
456-ECS	153	658	92	1181	159	1314-CE5	157
457-CS	153	680	141	1182	159	1315-C5	157
458-CS	153	709	94	1183	159	1315-CE5	157
458-ECS	153	725	92	1184	96, 159	1316-C6	157
459-CS	153	726	92	1185	159	1316-CE6	157
459-ECS	153	758	201	1186	96	1317-C8	157
464-CS	153	787	155	1186M	96	1317-CE8	157
465-CS	153	797	155	1195	158	1374-S	102
466-CS	153	800	201	1196	158	1500/3R/5	49
466-ECS	153	885	100	1197	158	1500S/3R/5	49
467-CS	153	886	100	1198	158	1500S/4R/10	49



INDEX

Numerical Index

Cat. No.	Page	Cat. No.	Page	Cat. No.	Page	Cat. No.	Page
1508	94	2108-F	63	3434-A	106	7507-CLH	142
1512	94	2108-H	63	3480	100	7719	109, 111, 114, 115, 118, 121, 124, 127, 130, 133, 146
1514	94	2109-B	63	3481	100	7719W	109, 111, 114, 115, 118, 121, 124, 127, 130, 133, 146
1520A	195	2109-D	63	4050	150	7789	109, 111, 114, 115, 118, 121, 124, 127, 130, 133, 146
1521A	195	2109-E	63	4051-A	150	7789W	109, 111, 114, 115, 118, 121, 124, 127, 130, 133, 146
1522A	195	2109-F	63	4051-B	150	8269	59
1544	57	2109-H	63	4052	150	8290-B	99
1546	57	2111-A	65	4053	150	8381	59
1547	57	2111-C	65	4054	150	8382	59
1548	59	2111-E	65	4055	150	8503	59
1549	57	2111-F	65	4060	141	8511	59
1575	201	2111-H	65	4060-AC	140	9110-A	143
1620	96	2112-A	65	4060-ACB	140	9110-B	143
1621	96	2112-C	65	4060-ACE	140	9110-BM	143
1622M	96	2112-E	65	4060-ACLH	140	9110-S	143
1627	96	2112-F	65	4060-C	140	9111-A	143
1628	96	2112-H	65	4060-CB	140	9112-A	143
1629M	96	2114-B	65	4060-CE	140	9112-B	143
1641-A	57	2114-D	65	4060-CLH	140	9112-BM	143
1642-A	57	2114-E	65	4061	141	9112-S	143
1643-A	57	2114-F	65	4061-AC	140	9199	143
1644-A	57	2118-A	65	4061-ACB	140	9512	94
1645-A	57	2118-C	65	4061-ACE	140	9514	94
1646-A	57	2118-E	65	4061-ACLH	140	9925	109, 111, 114, 115, 118, 121, 124, 127, 130, 133
1660	102	2118-F	65	4061-C	140	9925W	109, 111, 114, 115, 118, 121, 124, 127, 130, 133
1661	102	2118-K	65	4061-CB	140	9999A	109, 111, 114, 115, 118, 121, 124
1706	94	2119-B	65	4061-CE	140	10160-B	99
1708	94	2119-D	65	4061-CLH	140	10161-B	99
1713	96	2119-E	65	5090	58	10414	59
1714	96	2119-F	65	5200	51	10517	99
1715	96	2119-H	65	5557	98	11500	99
1722-C	171	2120-H	67	6065	51	12022	67
1722-CE	171	2120-K	67	6100	195	12023	67
1722-F	171	2130-H	67	6101	195	12110	99
1722-FE	171	2130-K	67	6301	100	12180-LSB	93
1723-C	171	2140	94	6304-BPF	173	12420	99
1723-CE	171	2160	94	6304-BPZ	173	12531	99
1723-YF	171	2171	102	6304-BTF	173	14010	60, 61, 63, 65
1723-YFE	171	2172	102	6304-BTZ	173	14011	63, 65
1724	96	2235	142	6304-DPF	173	14019	174
1724M	96	2241	142	6304-DPZ	173	14026	99
1752-C	171	2301	61	6304-DTF	173	14027	99
1752-CE	171	2302	61	6304-DTZ	173	14028	67, 99
1752-F	171	2305	60	6305-BPF	173	14038	61, 63, 65
1752-FE	171	2306	60	6305-BPZ	173	14110	99
1753-C	171	2308	61	6305-BTF	173	14111	99
1753-CE	171	2309	61	6305-BTZ	173	14511-XA	61
1753-YF	171	2315	60	6305-DPF	173	14312	67
1753-YFE	171	2318	61	6305-DPZ	173	14513-XA	60
1806	94	2321	61	6305-DTF	173	22016	145
1808	94	2322	61	6305-DTZ	173	22019	174
1906	94	2325	60	6306-BPF	173	22022	146
1908	94	2326	60	6306-BPZ	173	24016	145
1974	94	2328	61	6306-BTF	173	24019	174
2101-A	63	2329	61	6306-BTZ	173	24022	146
2101-C	63	2402	102	6306-DPF	173	31042	88
2101-E	63	2440	94	6306-DPZ	173	31142	88
2101-F	63	2450	94	6306-DTF	173	34019	174
2101-H	63	2506	98	6306-DTZ	173	42230-60-B	169
2102-A	63	2507	98	6306-EPF	173	42230-60-E	169
2102-C	63	2508	98	6306-EPF-IS	173	42230-60-IS-B	169
2102-E	63	2509	98	6306-EPZ	173	42230-60-IS-E	169
2102-F	63	2510	98	6306-EPZ-IS	173	42230-DF-B	169
2102-H	63	2516	98	6306-ETF	173	42230-DF-E	169
2104-B	63	2517	98	6306-ETF-IS	173	42230-SL-48-B	169
2104-D	63	2518	98	6306-ETZ	173	42230-SL-48-E	169
2104-E	63	2519	98	6306-ETZ-IS	173		
2104-F	63	2520	98	6851-10	97		
2106	94	2521	98	6851-12	97		
2108	94	3124-A	105	6851-14	97		
2108-A	63	3134-A	105	6851-16	97		
2108-C	63	3234-A	105	7502-CLH	142		
2108-E	63	3324-A	106	7504-CLH	142		



INDEX

Numerical Index

Cat. No.	Page	Cat. No.	Page	Cat. No.	Page	Cat. No.	Page
42230-SL-96-B	169	42250-SL-48-E	170	46220-60	121	114649-2	85
42230-SL-96-E	169	42250-SL-96-B	170	46220-60-IS	121	114649-3	85
42235-60-B	165	42250-SL-96-E	170	46240-60	121	114649-4	85
42235-60-E	165	42255-60-B	166	46240-60-IS	121	114649-5	85
42235-60-IS-B	165	42255-60-E	166	46265	127	114649-6	85
42235-60-IS-E	165	42255-60-IS-B	166	46420-60	124	114649-7	85
42235-DF-B	165	42255-60-IS-E	166	46420-60-IS	124	114649-8	85
42235-DF-E	165	42255-DF-B	166	46422-60	111	800020	93
42235-SL-48-B	165	42255-DF-E	166	46422-60-IS	111	800030	93
42235-SL-48-E	165	42255-SL-48-B	166	46422-60-8	111	800040	93
42235-SL-96-B	165	42255-SL-48-E	166	46422-60-12	111	800060	93
42235-SL-96-E	165	42255-SL-96-B	166	46422-60-16	111	800070	93
42240-60-B	168	42255-SL-96-E	166	46422-60-20	111	800080	93
42240-60-E	168	42330-60-B	169	46422-60-24	111	800090	93
42240-60-IS-B	168	42330-60-E	169	46422-60-28	111	800120	93
42240-60-IS-E	168	42335-60-B	165	46422-60-32	111	800140	93
42240-DF-B	168	42335-60-E	165	46432-60	118	800170	93
42240-DF-E	168	42340-60-B	168	46432-60-IS	118	800190	93
42240-SL-48-B	168	42340-60-E	168	46432-60-ISW	118	800200	93
42240-SL-48-E	168	42345-60-B	164	46432-60W	118	810619	93
42240-SL-96-B	168	42345-60-E	164	46440-60	124	813160	93
42240-SL-96-E	168	42350-60-B	170	46440-60-IS	124	813170	93
42245-60-B	164	42350-60-E	170	47200	130	813180	93
42245-60-E	164	42355-60-B	166	47203	130	813190	93
42245-60-IS-B	164	42355-60-E	166	47400	133	813200	93
42245-60-IS-E	164	44012	145	47403	133	813220	93
42245-DF-B	164	46200-60	109	55202-60	115	816660	93
42245-DF-E	164	46200-60-IS	109	55202-60W	115	816670	93
42245-SL-48-B	164	46200-60-8	109	57152	88	816680	93
42245-SL-48-E	164	46200-60-12	109	57252	88	816690	93
42245-SL-96-B	164	46200-60-16	109	57253	88	816700	93
42245-SL-96-E	164	46200-60-20	109	57353	88	820090	93
42250-60-B	170	46200-60-24	109	96265	127	820120	93
42250-60-E	170	46200-60-28	109	97200	130	823200	93
42250-60-IS-B	170	46200-60-32	109	97203	130	823220	93
42250-60-IS-E	170	46202-60	114	97400	133	824160	93
42250-DF-B	170	46202-60-IS	114	97403	133		
42250-DF-E	170	46202-60-ISW	114	114649-1	85		
42250-SL-48-B	170	46202-60W	114				

STOP PRESS

Notes

New all-purpose Vapour Tight and Dust Tight Industrial Luminaire for Indoor and Outdoor use.

Class II, Groups E, F and G and Class III Locations



02420

SPACING 1.5xM.H.		EFF 71.4%	
M.F.	INTENSIVE 02420 DISTRIBUTION	0.1%	
G.90		71.3%	
M.85			
P.80			
CEILING	75%	50%	
WALLS	50%	30%	10%
ROOM INDEX	COEFFICIENT OF UTILISATION		
J	.41	.39	.37
H	.49	.47	.47
M	.52	.52	.51
B	.56	.55	.54
D	.59	.57	.56
B	.61	.60	.59
D	.65	.62	.62
B	.66	.65	.62
B	.67	.65	.65
A	.68	.67	.65

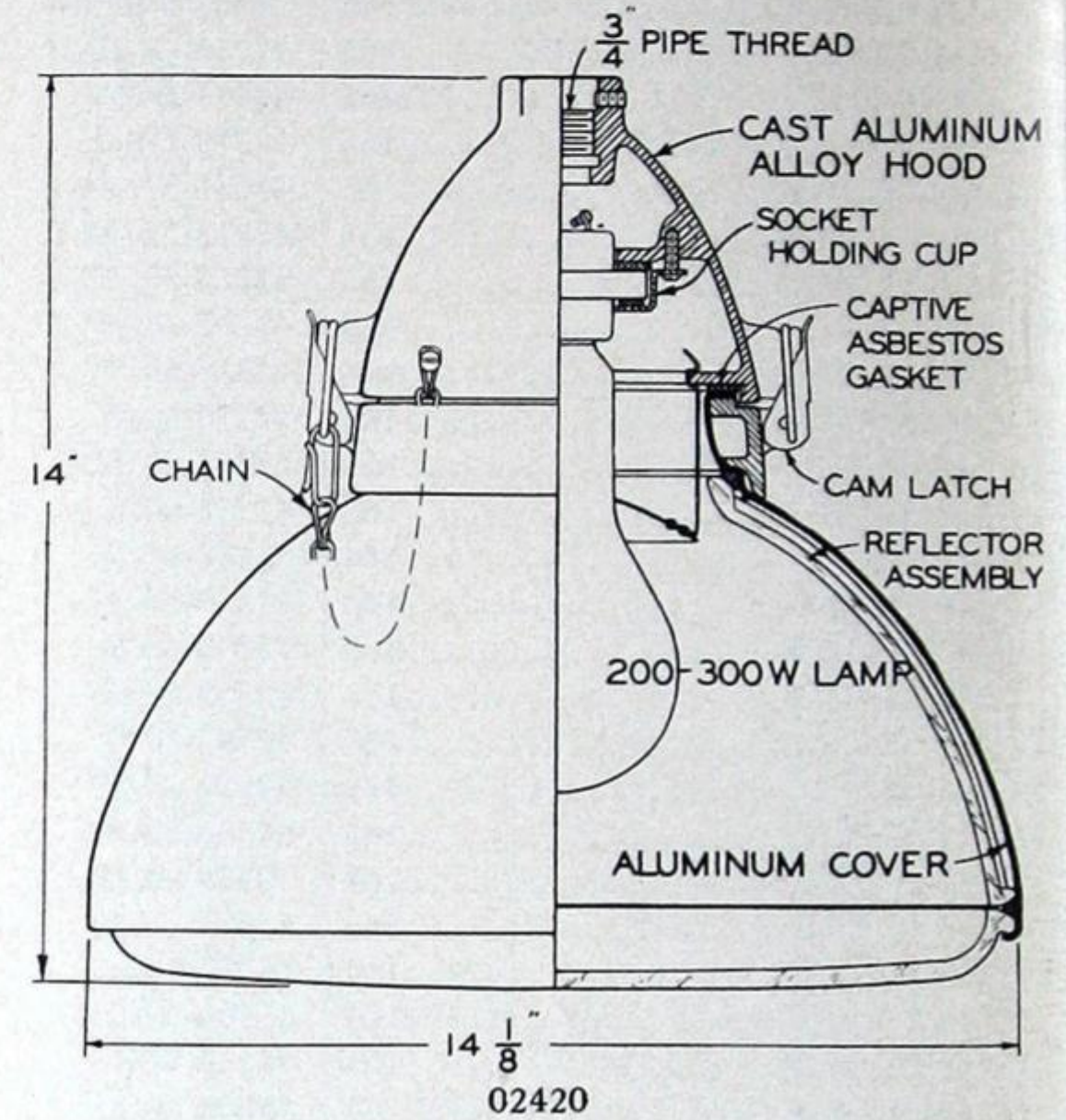

Applications

Chemical, ordnance, textile, woodworking, food processing and other plants require units designed to resist the entry of moisture or dust. No. 02420 is not only suited for such interior locations but can be used outdoors as well wherever high level illumination is needed for production and assembly operations.

Description and Performance

The nucleus of No. 02420 is a pre-assembled prismatic reflector and refracting plate combination, permanently held together by means of a spun metal cover. The assembly terminates in a metal hood which engages an asbestos gasket providing an effective vapour tight and dust tight seal. Positive pressure is assured at all times by means of a pair of latches that can not

loosen under vibration. The entire optical assembly is lowered on a short length of chain, provided with the unit, so that relamping is accomplished without the necessity of holding any of the unit parts.

The highly efficient prismatic glass reflecting-refracting plate combination produces an output equivalent to that of a conventional open bottom industrial unit so, for the first time, unequalled lighting efficiencies are obtained in a totally enclosed unit. The sharp cutoff at 60° effectively eliminates glare and brings all of the advantages of high quality lighting into industrial areas.

Installation

Units terminate in 3/4" female pipe thread fitters and are suspended from conduit to the desired height.

CATALOGUE DATA

Cat. No.	Lamp Wattage	Distribution	Max. Spacing Ratio	Dimensions in Inches		Termination	Net Wgt. Lbs. Each
				Diam.	Depth		
02420	200-300*	Intensive	1.5	14 1/8	14	3/4" female pipe thread	15 3/4

*Medium base—6" light center lamp.

FOR INDUSTRIAL LIGHTING EQUIPMENT REFER ILLUMINATION CATALOGUE I-53 INDUSTRIAL

Digitized by:



ASSOCIATION FOR
PRESERVATION TECHNOLOGY,
INTERNATIONAL

BUILDING
TECHNOLOGY
HERITAGE
LIBRARY

www.apti.org

From the collection of:



CANADIAN CENTRE FOR ARCHITECTURE /
CENTRE CANADIEN D'ARCHITECTURE

www.cca.qc.ca

